



US00D678775S

(12) **United States Design Patent**
Daniele

(10) **Patent No.:** **US D678,775 S**
(45) **Date of Patent:** **** Mar. 26, 2013**

(54) **BOTTLE**

(75) Inventor: **Feletto Daniele**, San Polo di Piave (IT)

(73) Assignee: **Vetroelite SpA**, Ormelle (TV) (IT)

(**) Term: **14 Years**

(21) Appl. No.: **29/375,904**

(22) Filed: **Sep. 29, 2010**

(51) **LOC (9) Cl.** **09-01**

(52) **U.S. Cl.** **D9/545**; D9/544; D9/546; D9/555;
D9/568; D9/571; D9/575

(58) **Field of Classification Search** D9/516,
D9/530, 541-546, 549, 558, 571-575, 682,
D9/686-692, 694, 552-553, 555, 568; D7/300,
D7/598; 215/379, 381-384; 220/660, 662,
220/669-673, 675

See application file for complete search history.

(56) **References Cited**

U.S. PATENT DOCUMENTS

D199,202 S * 9/1964 Platte D9/542
D213,263 S * 1/1969 Knowles et al. D9/555

D480,308 S * 10/2003 Grisdale et al. D9/520
D488,386 S * 4/2004 Hall et al. D9/550
D536,256 S * 2/2007 Nagata D9/557
D580,770 S * 11/2008 Matauch D9/551
D604,620 S * 11/2009 Rica D9/522
D604,621 S * 11/2009 Rica D9/522
D613,175 S * 4/2010 Delbon D9/545
D621,716 S * 8/2010 Camby D9/545
D635,032 S * 3/2011 Daniele D9/545

* cited by examiner

Primary Examiner — Ian Simmons

Assistant Examiner — Dana L Meyrow

(74) *Attorney, Agent, or Firm* — Egbert Law Offices, PLLC

(57) **CLAIM**

The ornamental design for a bottle, as shown and described.

DESCRIPTION

FIG. 1 is an upper perspective view of the bottle showing my design.

FIG. 2 is a front view thereof;

FIG. 3 is a back view thereof;

FIG. 4 is a side view thereof;

FIG. 5 is an opposite side view thereof;

FIG. 6 is a bottom view thereof; and,

FIG. 7 is a top view thereof.

1 Claim, 3 Drawing Sheets

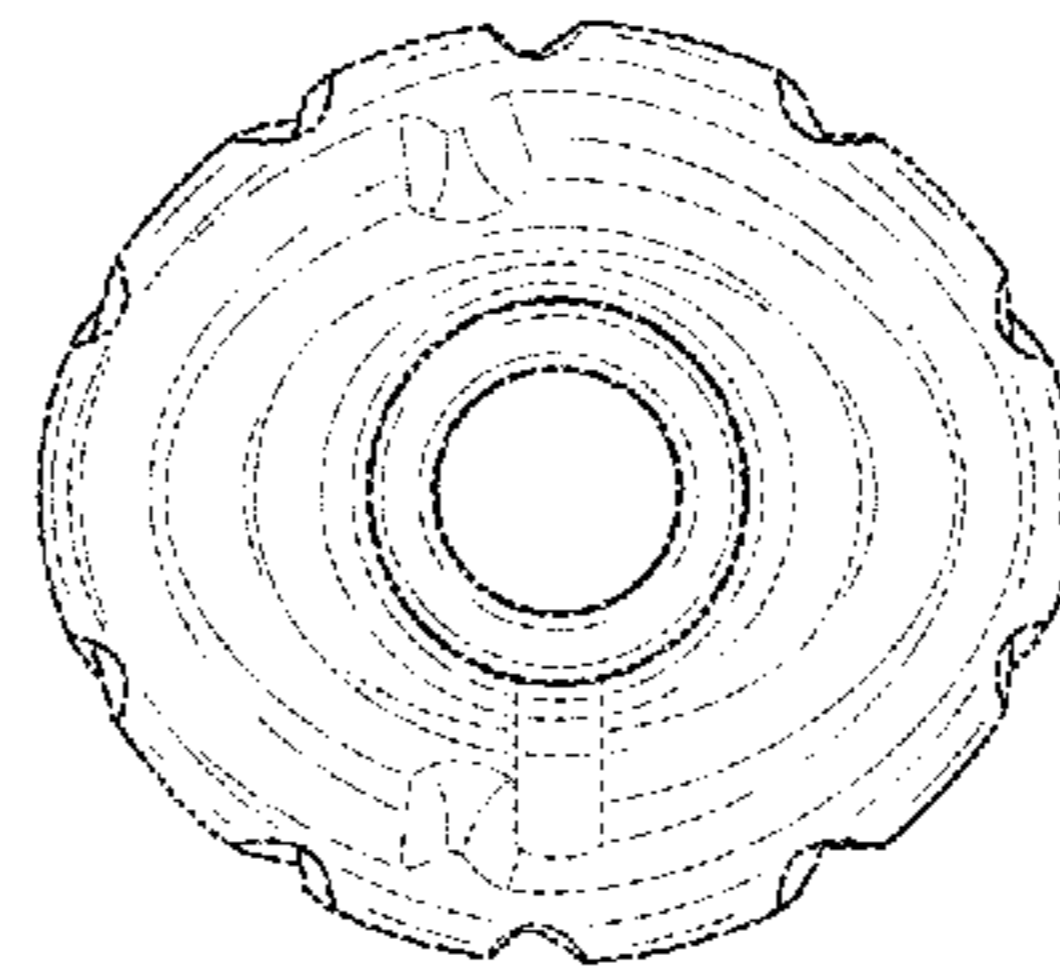
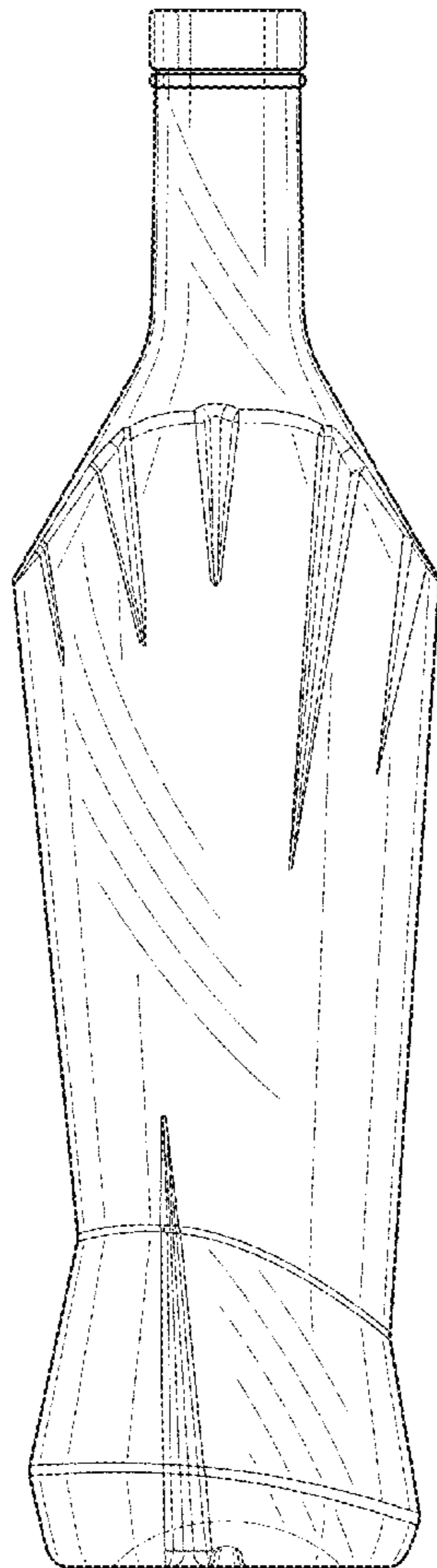

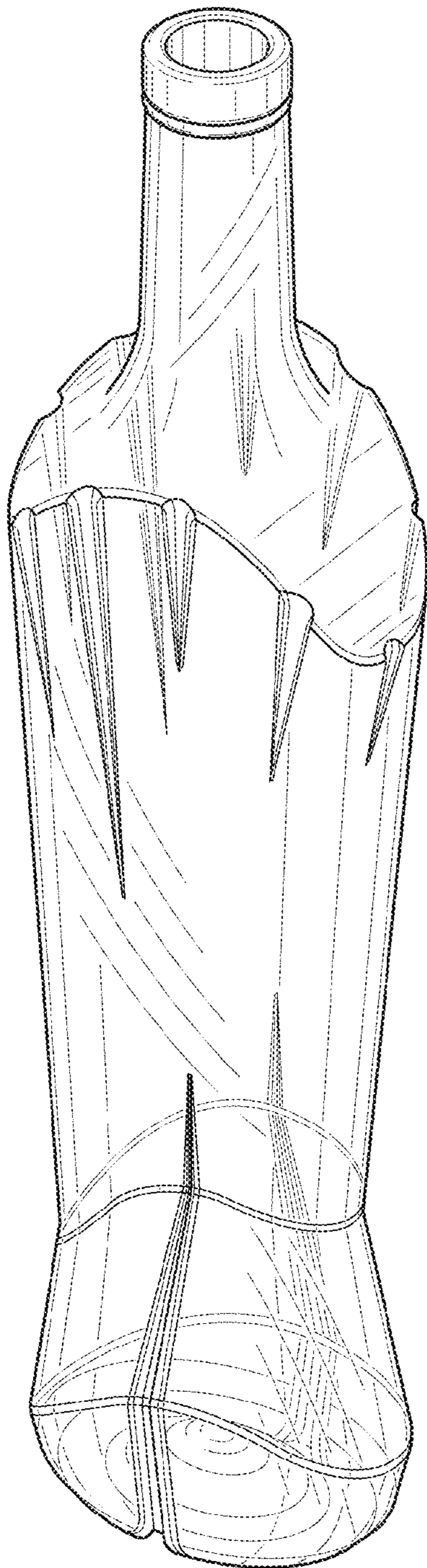

FIG. 1

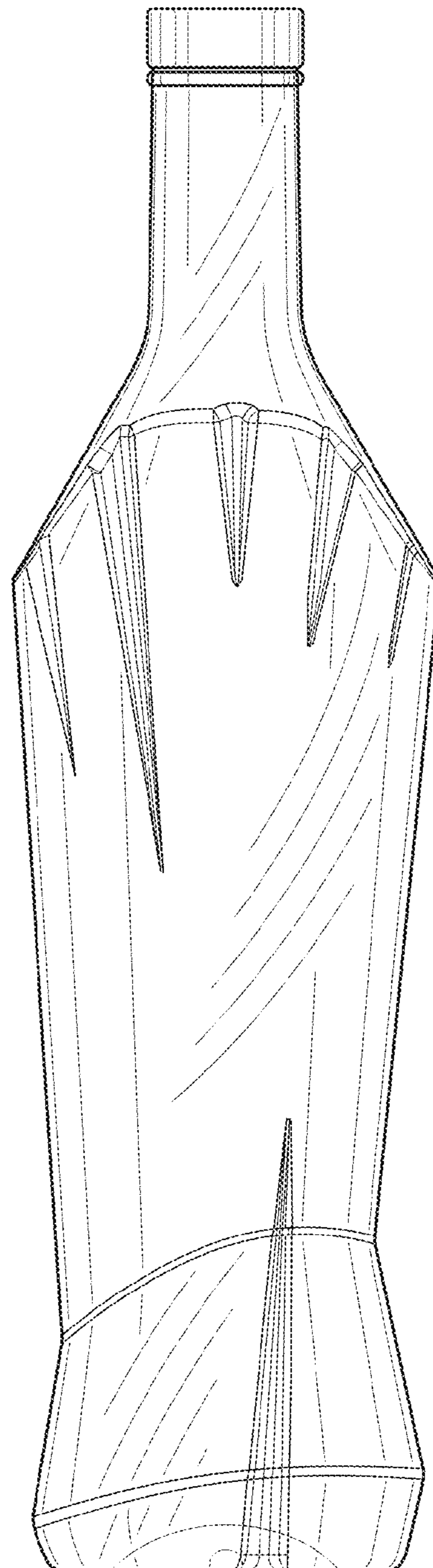

FIG. 2

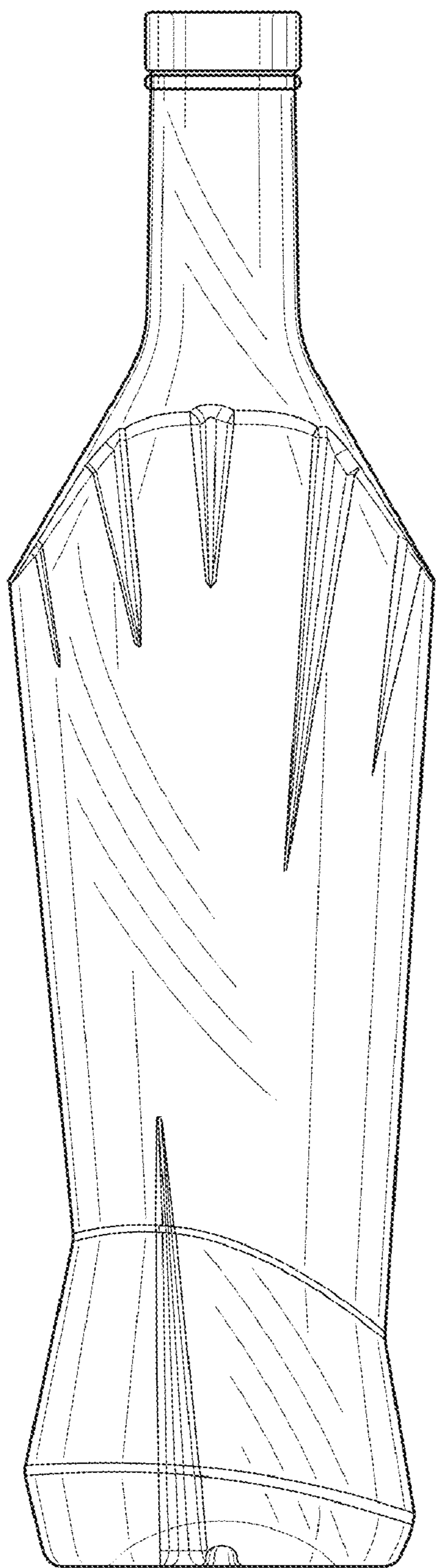

FIG. 3

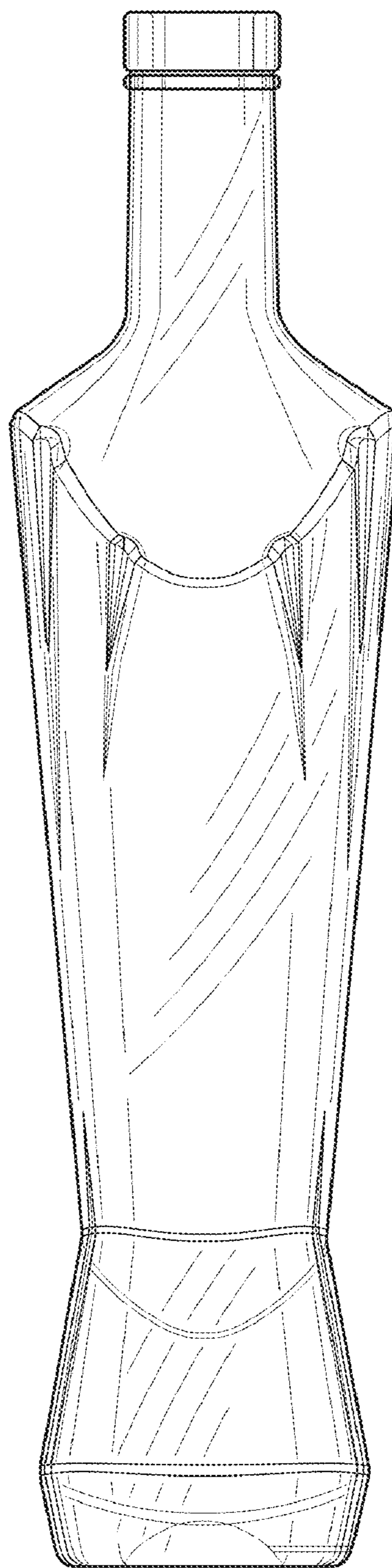

FIG. 4

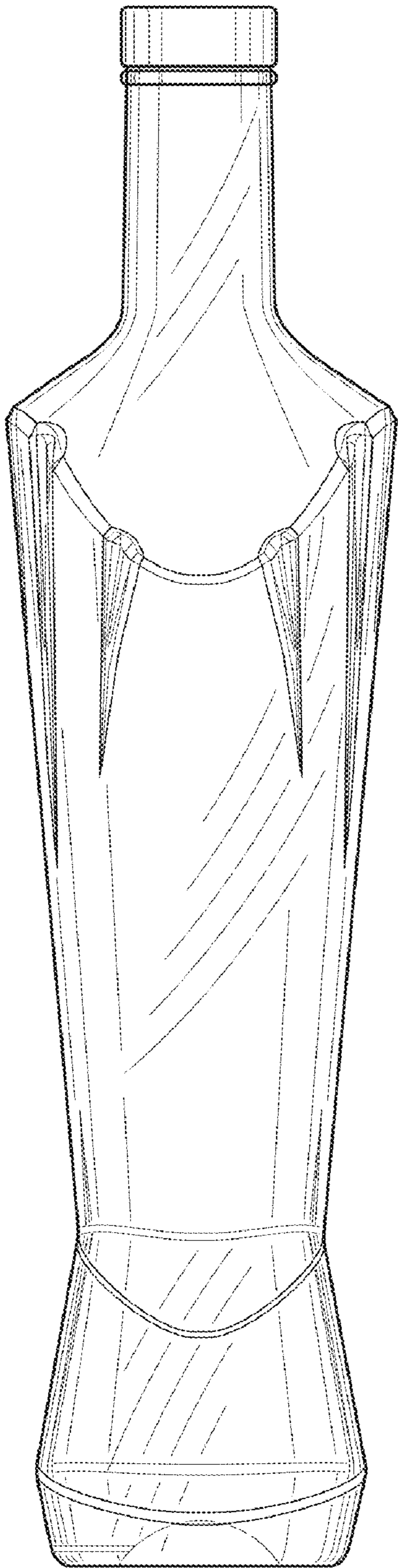

FIG. 5

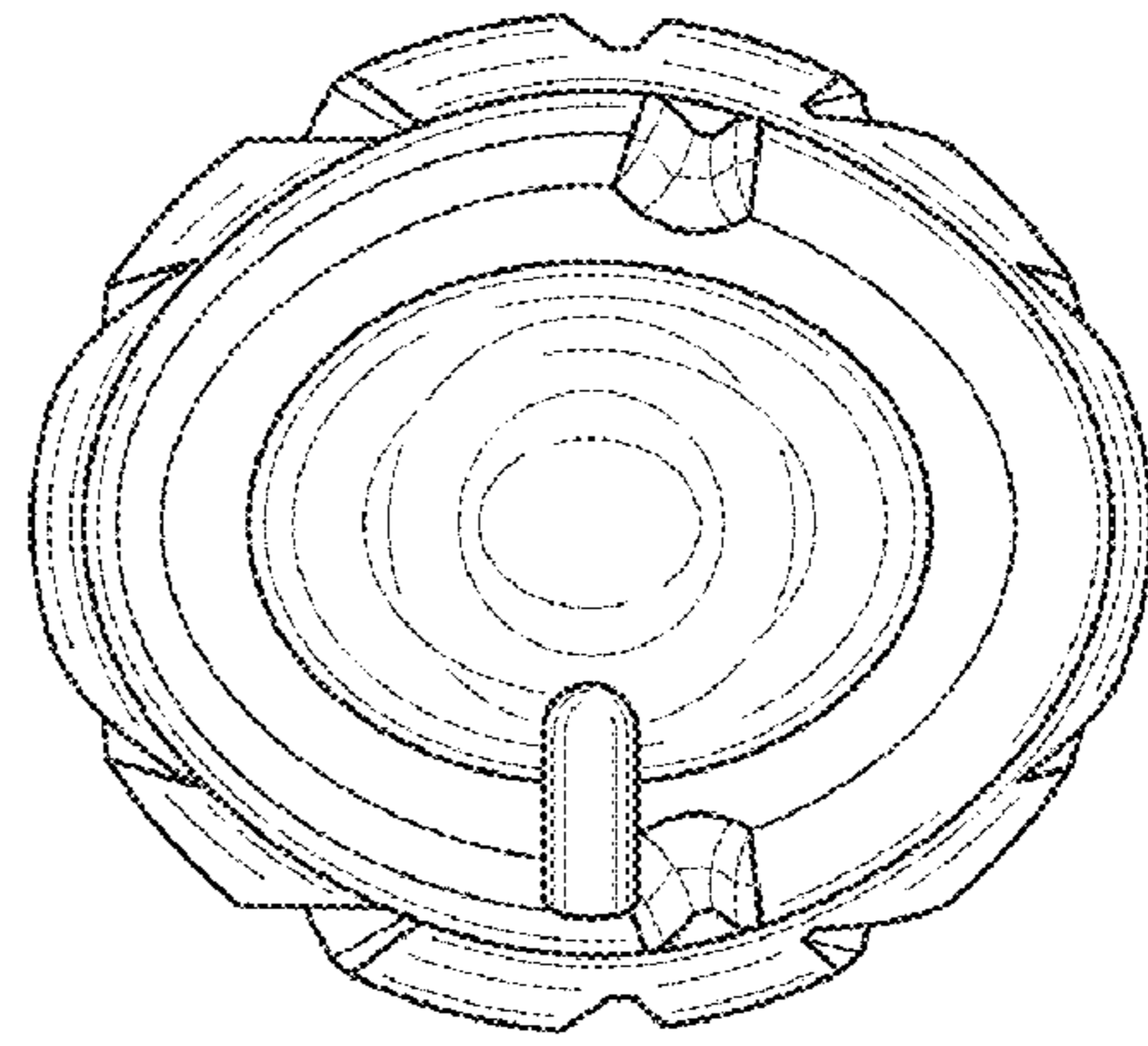

FIG. 6

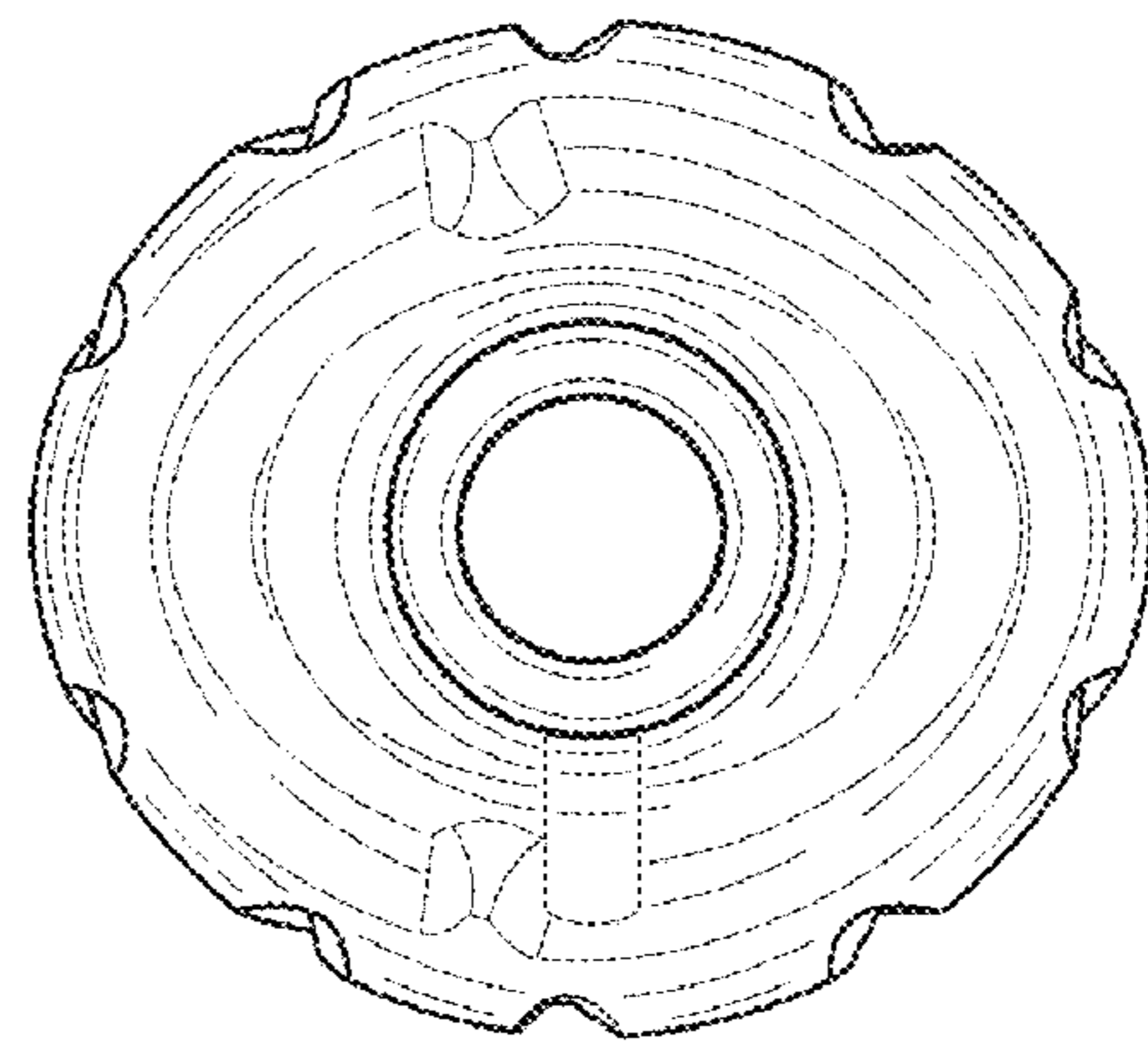

FIG. 7