

US00D678720S

(12) **United States Design Patent**  
**Segers et al.**

(10) **Patent No.:** **US D678,720 S**  
(45) **Date of Patent:** **\*\* Mar. 26, 2013**

(54) **COOKING APPLIANCE**

(75) Inventors: **Hermann-Reinhard Segers**, München (DE); **Sören Strayle**, München (DE)

(73) Assignee: **BSH Bosch und Siemens Hausgeraete GmbH**, Munich (DE)

(\*\*) Term: **14 Years**

(21) Appl. No.: **29/426,277**

(22) Filed: **Jul. 3, 2012**

**Related U.S. Application Data**

(62) Division of application No. 29/418,939, filed on Apr. 24, 2012, now Pat. No. Des. 668,104, which is a division of application No. 29/411,278, filed on Jan. 19, 2012, now Pat. No. Des. 663,583, which is a division of application No. 29/403,349, filed on Oct. 5, 2011, now Pat. No. Des. 666,054, which is a division of application No. 29/376,443, filed on Oct. 7, 2010, now Pat. No. Des. 651,458.

(30) **Foreign Application Priority Data**

Apr. 14, 2010 (EM) ..... 001210603  
May 27, 2010 (EM) ..... 001220008

(51) **LOC (9) Cl.** ..... **07-02**

(52) **U.S. Cl.** ..... **D7/402; D7/340**

(58) **Field of Classification Search** ..... D7/323,  
D7/340-348, 402-409, 362; 126/39 B, 211,  
126/214 C, 214 R, 215-218, 152 R; 219/460.1,  
219/506

See application file for complete search history.

(56) **References Cited**

U.S. PATENT DOCUMENTS

|          |   |   |         |                  |       |        |
|----------|---|---|---------|------------------|-------|--------|
| D336,210 | S | * | 6/1993  | Birtwisle        | ..... | D7/340 |
| D342,641 | S | * | 12/1993 | Falk             | ..... | D7/407 |
| D343,336 | S | * | 1/1994  | Falk             | ..... | D7/346 |
| D393,567 | S | * | 4/1998  | Ashcraft et al.  | ..... | D7/346 |
| D412,808 | S | * | 8/1999  | Hinton et al.    | ..... | D7/362 |
| D477,496 | S | * | 7/2003  | Monguilod et al. | ..... | D7/340 |
| D477,497 | S | * | 7/2003  | Monguilod        | ..... | D7/340 |
| D491,411 | S | * | 6/2004  | De Mello         | ..... | D7/340 |
| D495,918 | S | * | 9/2004  | De Mello         | ..... | D7/340 |
| D540,103 | S | * | 4/2007  | Jensen et al.    | ..... | D7/346 |
| D578,349 | S | * | 10/2008 | Rieser           | ..... | D7/402 |
| D585,696 | S | * | 2/2009  | Monteiro         |       |        |
|          |   |   |         | Sindeaux et al.  | ..... | D7/340 |
| D609,960 | S | * | 2/2010  | Cutino           | ..... | D7/346 |
| D637,040 | S | * | 5/2011  | King et al.      | ..... | D7/407 |
| D652,247 | S | * | 1/2012  | Monteiro         |       |        |
|          |   |   |         | Sindeaux et al.  | ..... | D7/340 |

\* cited by examiner

*Primary Examiner* — T. Chase Nelson

*Assistant Examiner* — Mark Cavanna

(74) *Attorney, Agent, or Firm* — James E. Howard; Andre Pallapies

(57) **CLAIM**

The ornamental design for a cooking appliance, as shown and described.

**DESCRIPTION**

FIG. 1 is a front perspective view showing a cooking appliance according to a first embodiment of our new ornamental design;

FIG. 2 is a top view thereof;

FIG. 3 is a right side view thereof, with the left side view thereof being a mirror image thereof;

FIG. 4 is a bottom view thereof;

FIG. 5 is a front view thereof; and,

FIG. 6 is a rear view thereof.

**1 Claim, 4 Drawing Sheets**

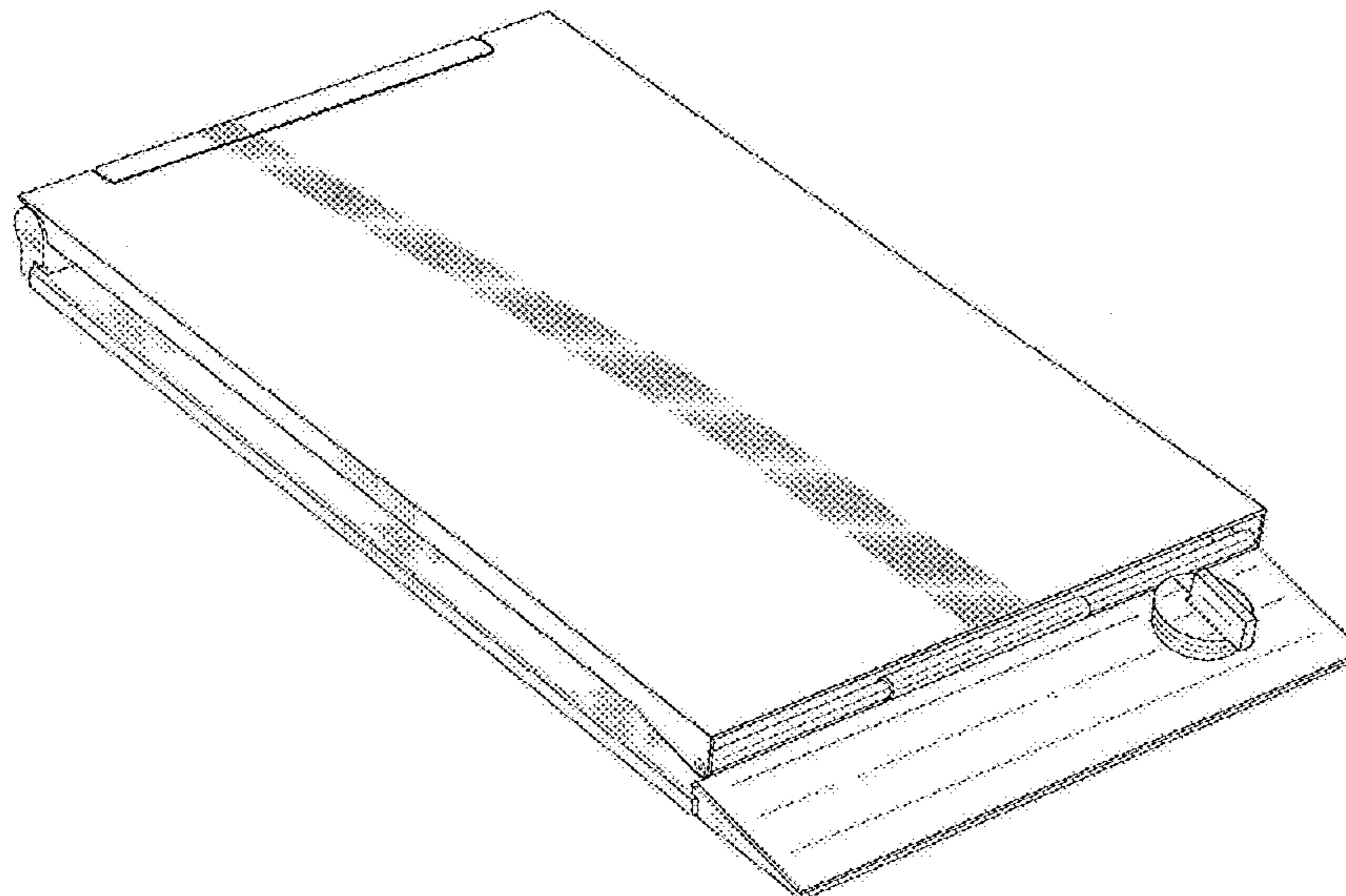

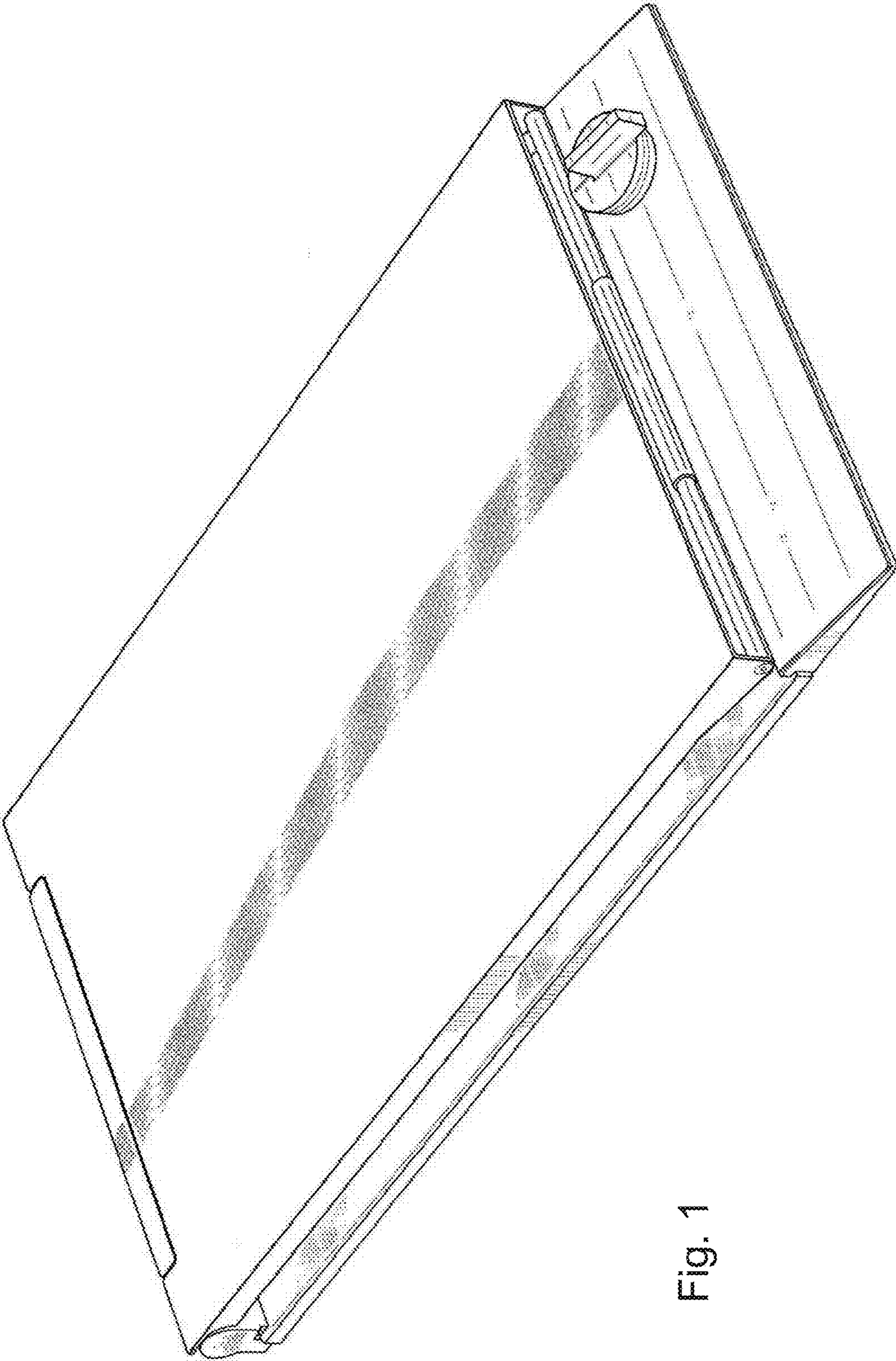

Fig. 1

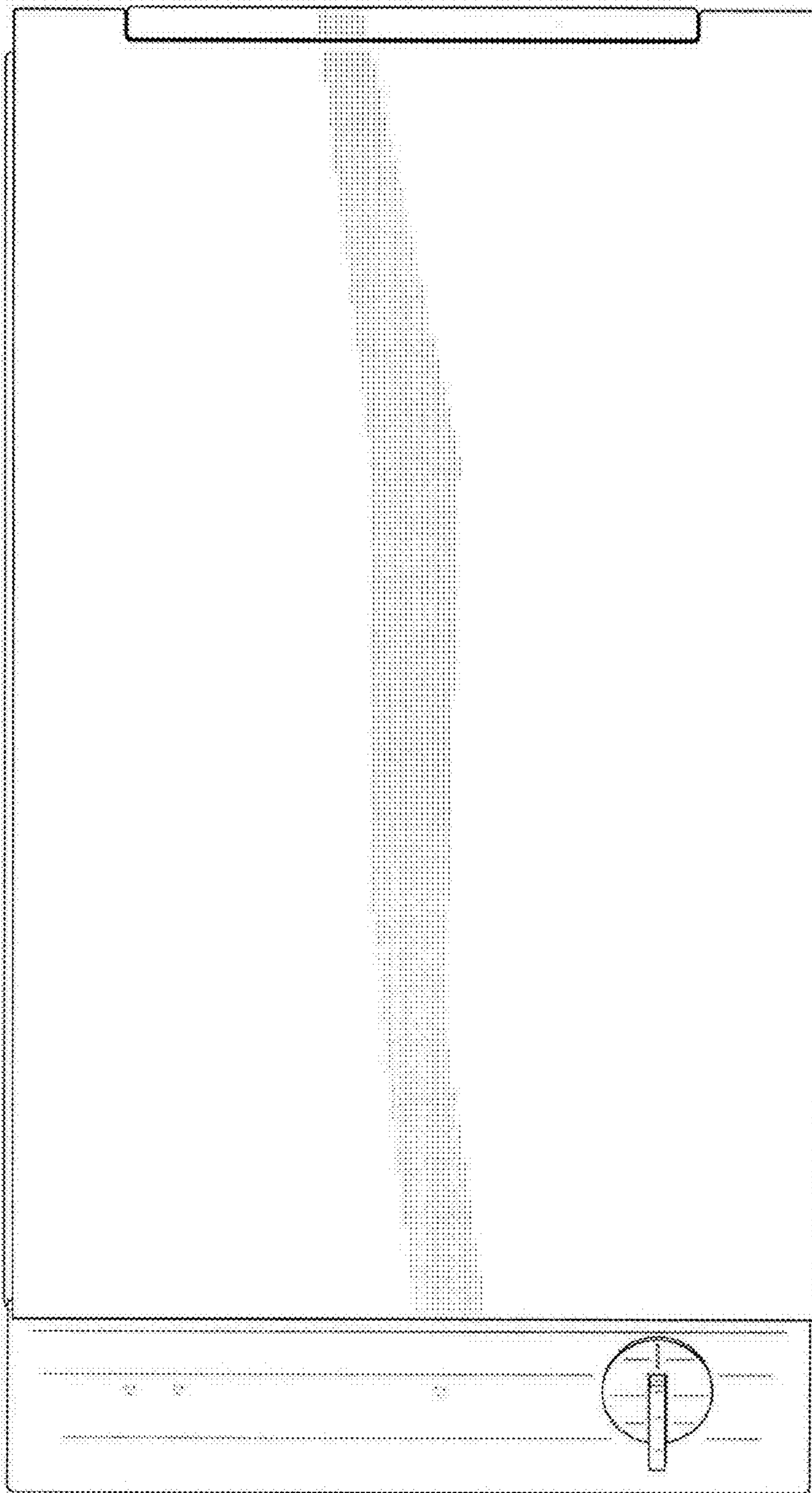

Fig. 2

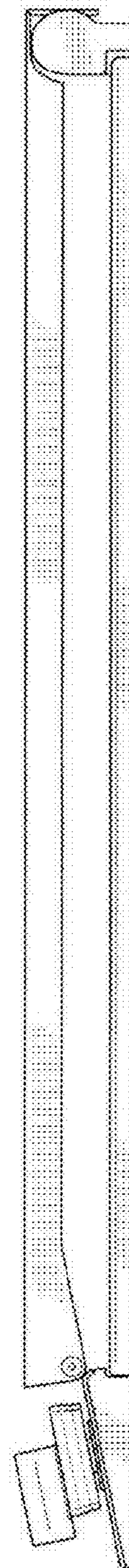

Fig. 3

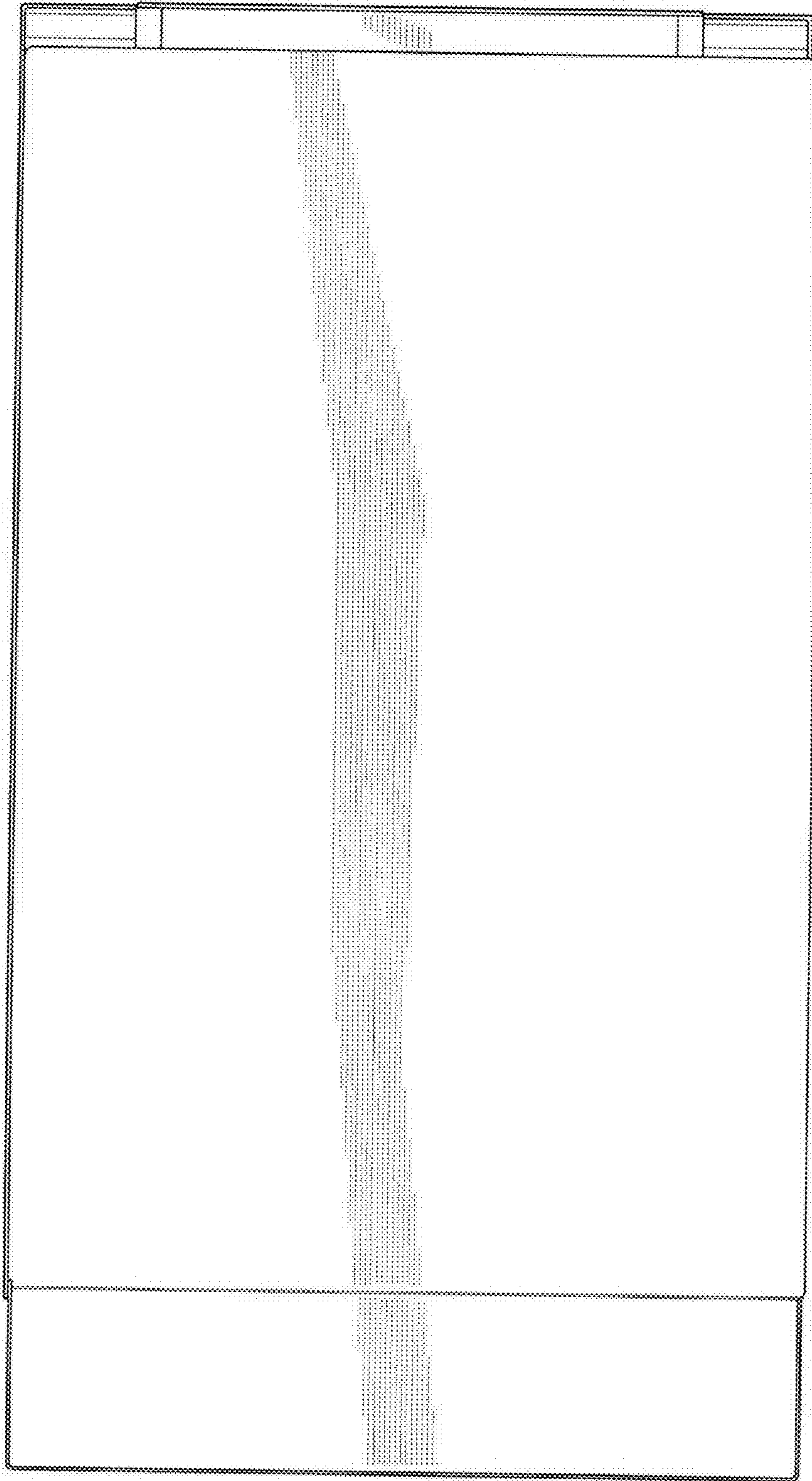

Fig. 4

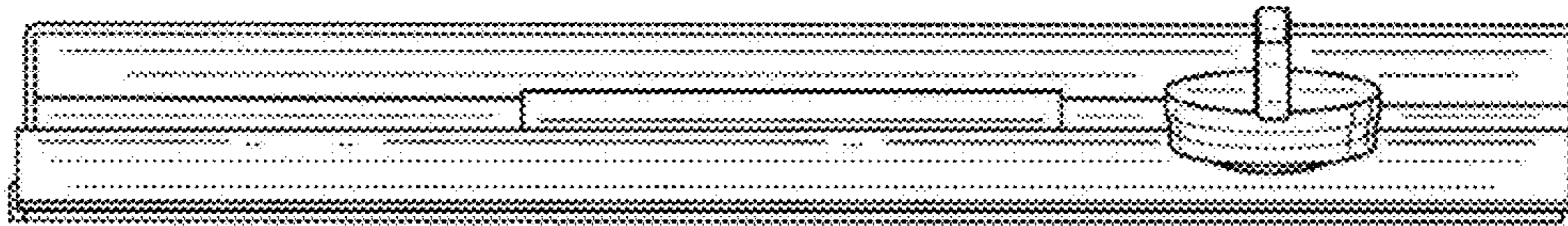

Fig. 5

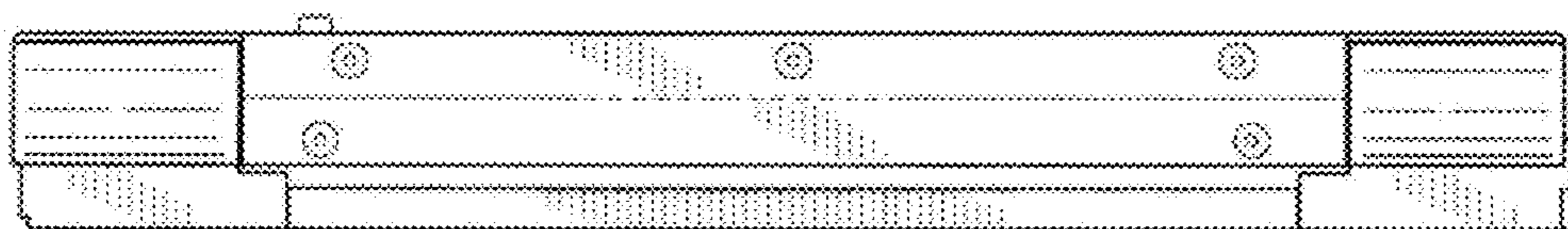

Fig. 6