

US00D678594S

(12) **United States Design Patent**
McCane

(10) **Patent No.:** **US D678,594 S**

(45) **Date of Patent:** **** Mar. 19, 2013**

(54) **LIGHT FIXTURE**

(75) Inventor: **Stephen Barry McCane**, McDonough,
GA (US)

(73) Assignee: **ABL IP Holding LLC**, Conyers, GA
(US)

(**) Term: **14 Years**

(21) Appl. No.: **29/390,023**

(22) Filed: **Apr. 19, 2011**

(51) **LOC (9) Cl.** **26-99**

(52) **U.S. Cl.** **D26/118**

(58) **Field of Classification Search** D26/88,
D26/91, 85, 86, 72, 74, 76, 118, 90, 134,
D26/73, 75, 119, 120, 121, 122, 113, 71,
D26/84, 128, 129, 2, 125, 78, 77, 138, 26,
D26/89, 124, 130, 9, 10, 11, 24, 25, 63, 64,
D26/65, 69, 127; 362/311.13, 249.01–249.12,
362/373, 362, 326, 247, 342, 220, 147, 148,
362/282, 339, 620, 223, 376, 219; D23/412,
D23/385, 388; 349/64, 62, 63, 65; D16/101;
D13/179, 180

See application file for complete search history.

(56) **References Cited**

U.S. PATENT DOCUMENTS

D155,306	S	*	9/1949	Meyer	D26/77
2,567,779	A	*	9/1951	Mitchell	362/220
2,621,285	A	*	12/1952	Nitardy	362/225
2,625,646	A	*	1/1953	Goebel	362/224
D177,268	S	*	3/1956	McCormack	D26/77
2,946,880	A	*	7/1960	Picha et al.	362/224
D209,534	S	*	12/1967	Eisenberg	D26/121
3,381,124	A	*	4/1968	Eisenberg	362/354
4,015,811	A	*	4/1977	Nute et al.	248/343
4,268,897	A	*	5/1981	Schierwagen et al.	362/325
4,429,354	A	*	1/1984	Garnett	362/342
4,967,324	A	*	10/1990	Barclay	362/147
D365,409	S	*	12/1995	Lu	D26/77
5,564,815	A	*	10/1996	Littman et al.	362/147
D378,860	S	*	4/1997	Galletly	D26/77
5,803,585	A	*	9/1998	Littman et al.	362/147
5,908,234	A	*	6/1999	Kreeft	362/223

5,944,411	A	*	8/1999	Holten et al.	362/342
6,092,913	A	*	7/2000	Edwards, Jr.	362/260
6,164,800	A	*	12/2000	McIlwraith	362/342
6,301,770	B1	*	10/2001	McIlwraith	29/527.2
D485,932	S	*	1/2004	Crane	D26/76
7,036,957	B2	*	5/2006	Paravantsos	362/247
7,090,379	B2	*	8/2006	Targetti	362/342
7,108,398	B2	*	9/2006	Holten	362/292
D586,948	S	*	2/2009	Mayfield et al.	D26/121
D593,697	S	*	6/2009	Liu et al.	D26/74
D594,590	S	*	6/2009	Mayfield et al.	D26/121
D611,644	S	*	3/2010	Tsai	D26/77
7,828,468	B2	*	11/2010	Mayfield et al.	362/342
D640,825	S	*	6/2011	Schmidt et al.	D26/121
8,220,957	B2	*	7/2012	Lydecker et al.	362/222
2007/0195531	A1	*	8/2007	Paravantsos	362/282
2007/0253205	A1	*	11/2007	Welker	362/373
2007/0297181	A1	*	12/2007	Mayfield et al.	362/342
2008/0278943	A1	*	11/2008	Van Der Poel	362/240

* cited by examiner

Primary Examiner — Kevin Rudzinski

(74) *Attorney, Agent, or Firm* — Kilpatrick Townsend &
Stockton LLP

(57) **CLAIM**

The ornamental design for a light fixture, as shown and
described.

DESCRIPTION

FIG. 1 is a bottom perspective view of an embodiment of a
light fixture.

FIG. 2 is a bottom plan view of the light fixture of FIG. 1.

FIG. 3 is a top plan view of the light fixture of FIG. 1.

FIG. 4 is a right side elevation view of the light fixture of FIG.
1.

FIG. 5 is a left side elevation view of the light fixture of FIG.
1.

FIG. 6 is a front elevation view of the light fixture of FIG. 1.

FIG. 7 is a rear elevation view of the light fixture of FIG. 1.

FIG. 8 is a cross-sectional view of the light fixture taken along
line 8-8 of FIG. 2.

FIG. 9 is an enlarged isolated view of a reflector of the light
fixture of FIG. 8.

FIG. 10 is a bottom perspective view of another embodiment
of a light fixture.

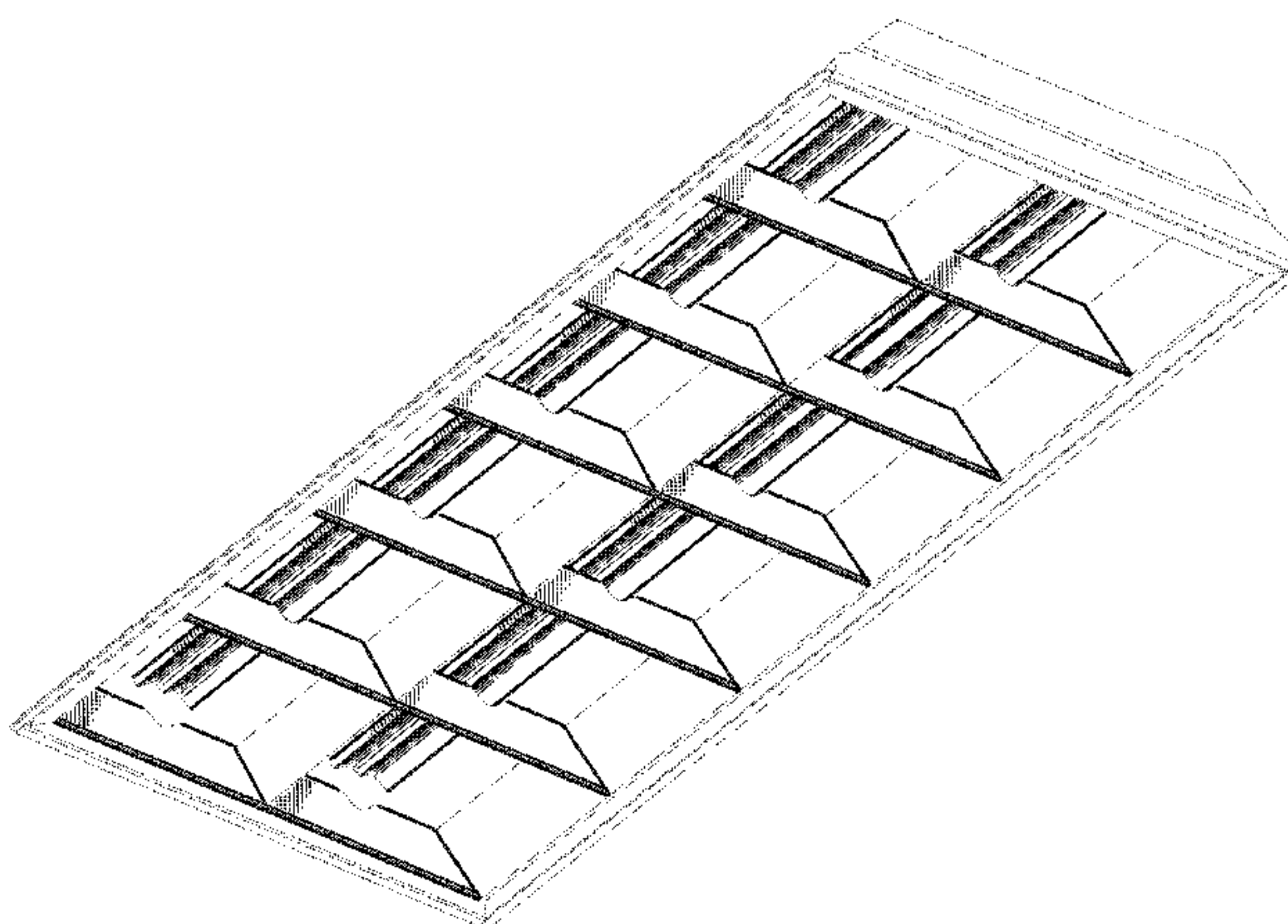

FIG. 11 is a bottom plan view of the light fixture of FIG. 10.
FIG. 12 is a top plan view of the light fixture of FIG. 10.
FIG. 13 is a right side elevation view of the light fixture of FIG. 10.
FIG. 14 is a left side elevation view of the light fixture of FIG. 10.
FIG. 15 is a front elevation view of the light fixture of FIG. 10.
FIG. 16 is a rear elevation view of the light fixture of FIG. 10.
FIG. 17 is a cross-sectional view of the light fixture taken along line 17-17 of FIG. 11.
FIG. 18 is an enlarged isolated view of a reflector of the light fixture of FIG. 17.
FIG. 19 is a bottom perspective view of another embodiment of a light fixture.
FIG. 20 is a bottom plan view of the light fixture of FIG. 19.
FIG. 21 is a top plan view of the light fixture of FIG. 19.
FIG. 22 is a right side elevation view of the light fixture of FIG. 19.
FIG. 23 is a left side elevation view of the light fixture of FIG. 19.
FIG. 24 is a front elevation view of the light fixture of FIG. 19.
FIG. 25 is a rear elevation view of the light fixture of FIG. 19.
FIG. 26 is a cross-sectional view of the light fixture taken along line 26-26 of FIG. 20.

FIG. 27 is an enlarged isolated cross-sectional view of a reflector of the light fixture of FIG. 26.
FIG. 28 is an enlarged isolated cross-sectional view of a louver blade taken along line 28-28 of FIG. 26.
FIG. 29 is a bottom perspective view of another embodiment of a light fixture.
FIG. 30 is a bottom plan view of the light fixture of FIG. 29.
FIG. 31 is a top plan view of the light fixture of FIG. 29.
FIG. 32 is a right side elevation view of the light fixture of FIG. 29.
FIG. 33 is a left side elevation view of the light fixture of FIG. 29.
FIG. 34 is a front elevation view of the light fixture of FIG. 29.
FIG. 35 is a rear elevation view of the light fixture of FIG. 29.
FIG. 36 is a cross-sectional view of the light fixture taken along line 38-38 of FIG. 30.
FIG. 37 is an enlarged isolated cross-sectional view of a reflector of the light fixture of FIG. 36; and,
FIG. 38 is an enlarged isolated cross-sectional view of a louver blade taken along line 38-38 of FIG. 36.
Portions or features of the light fixture not shown in the drawings form no part of the claimed design. The broken lines in the drawings illustrating portions of the lighting fixture form no part of the claimed design.

1 Claim, 20 Drawing Sheets

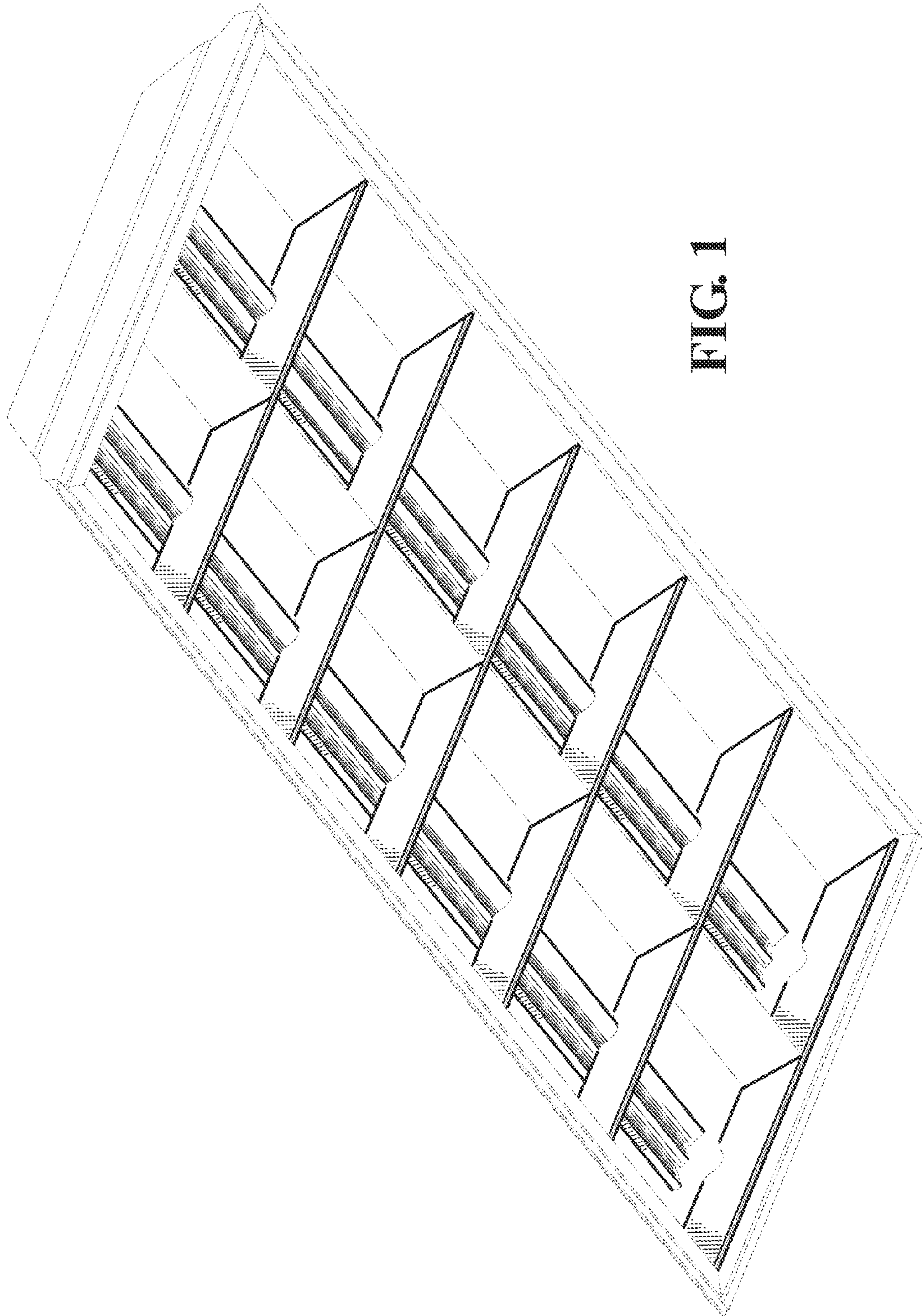

FIG. 1

FIG. 2

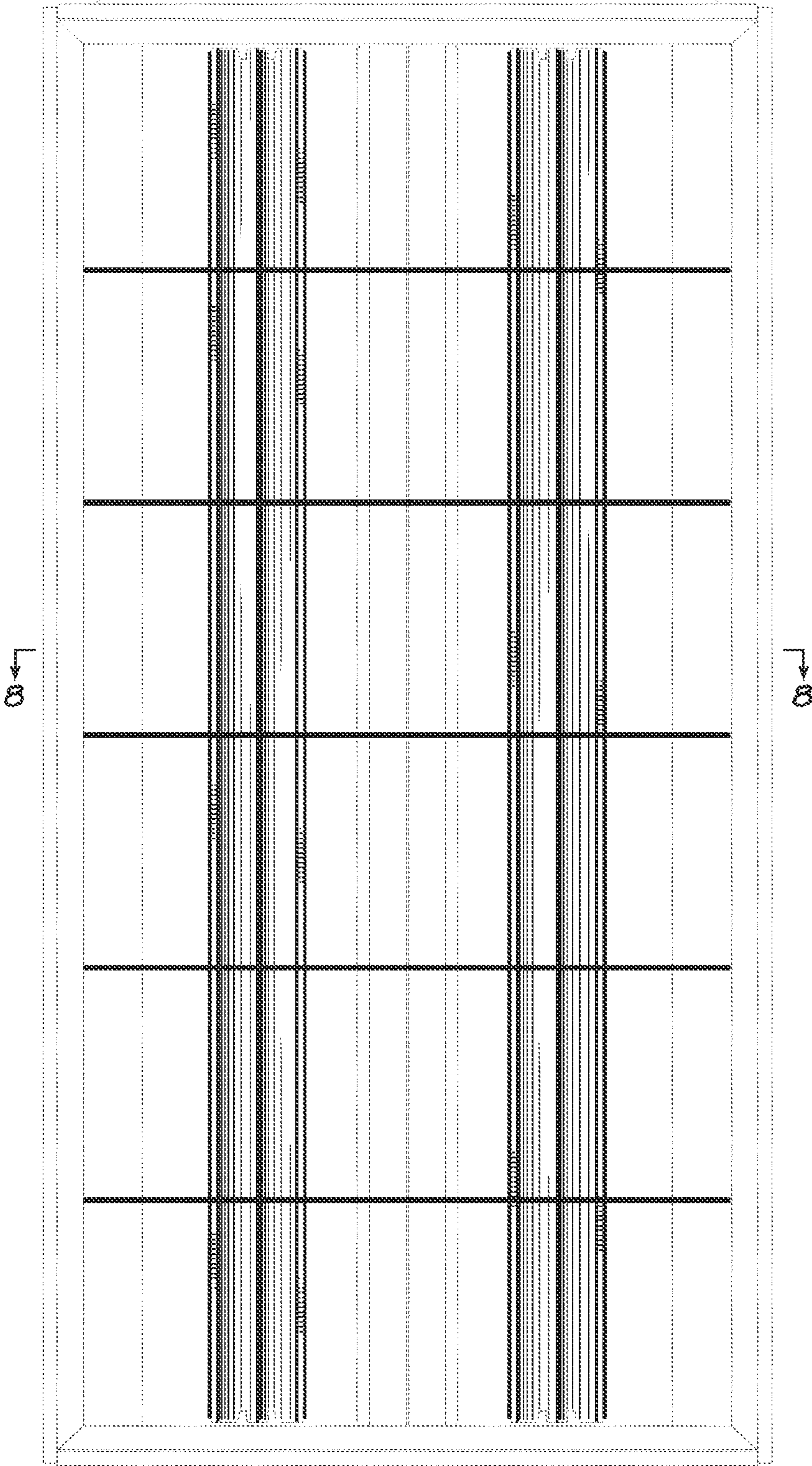
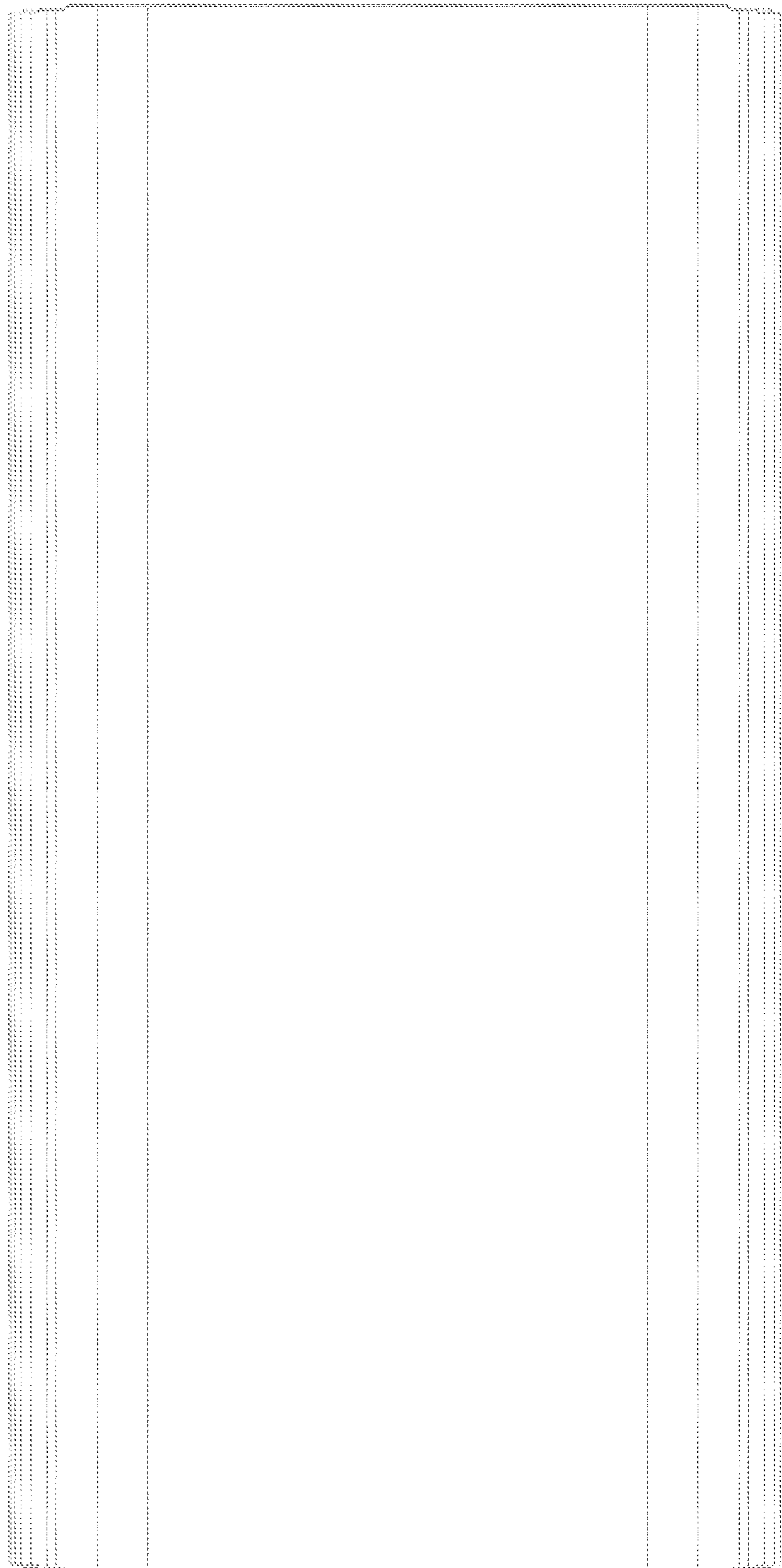

FIG. 3



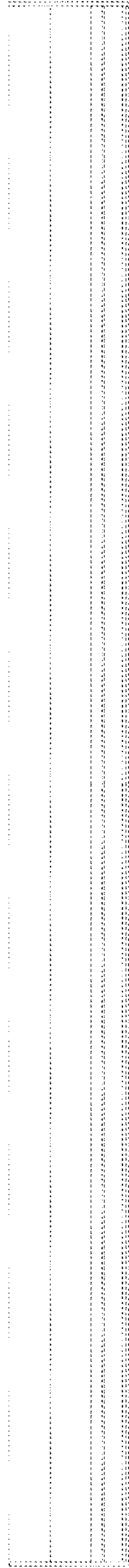

FIG. 4

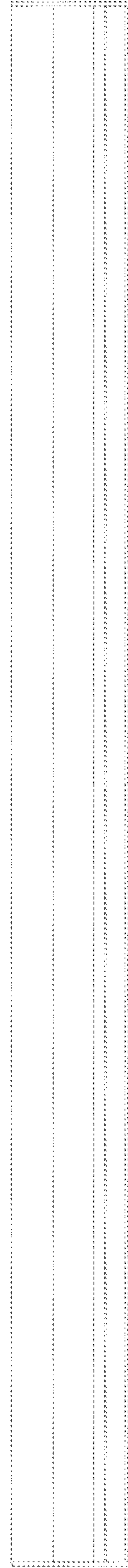

FIG. 5



FIG. 6

FIG. 7

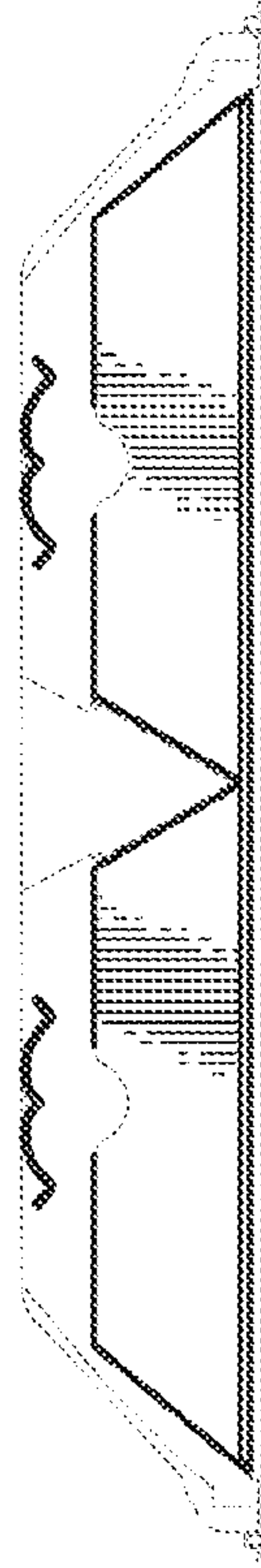

FIG. 8

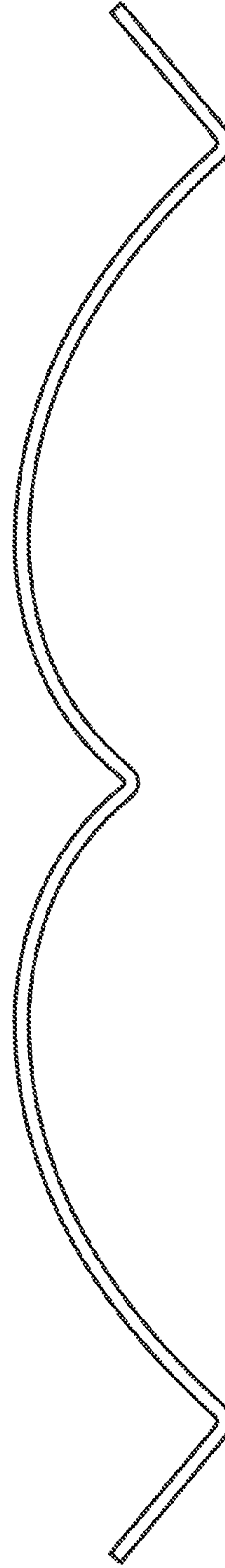

FIG. 9

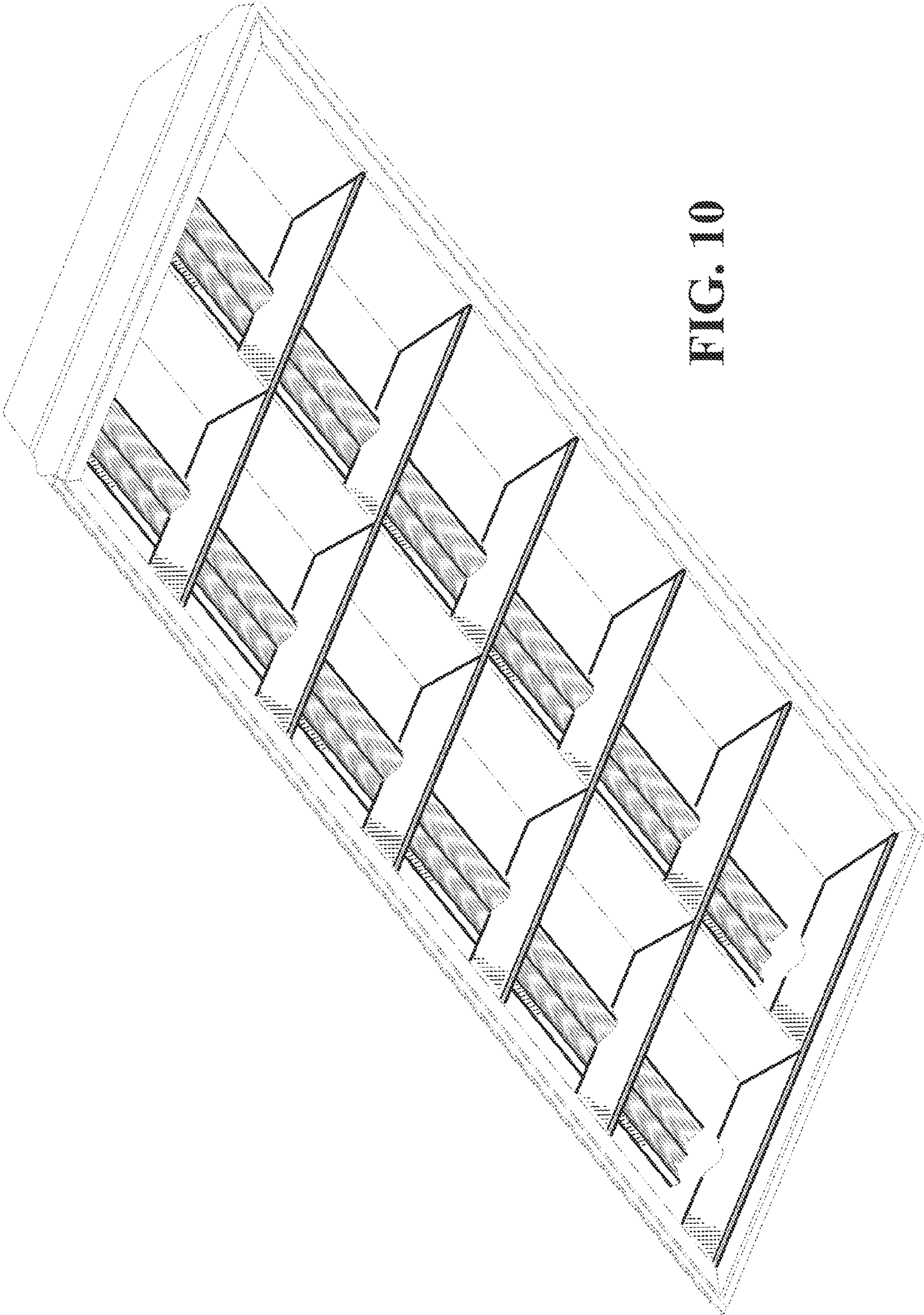

FIG. 10

FIG. 11

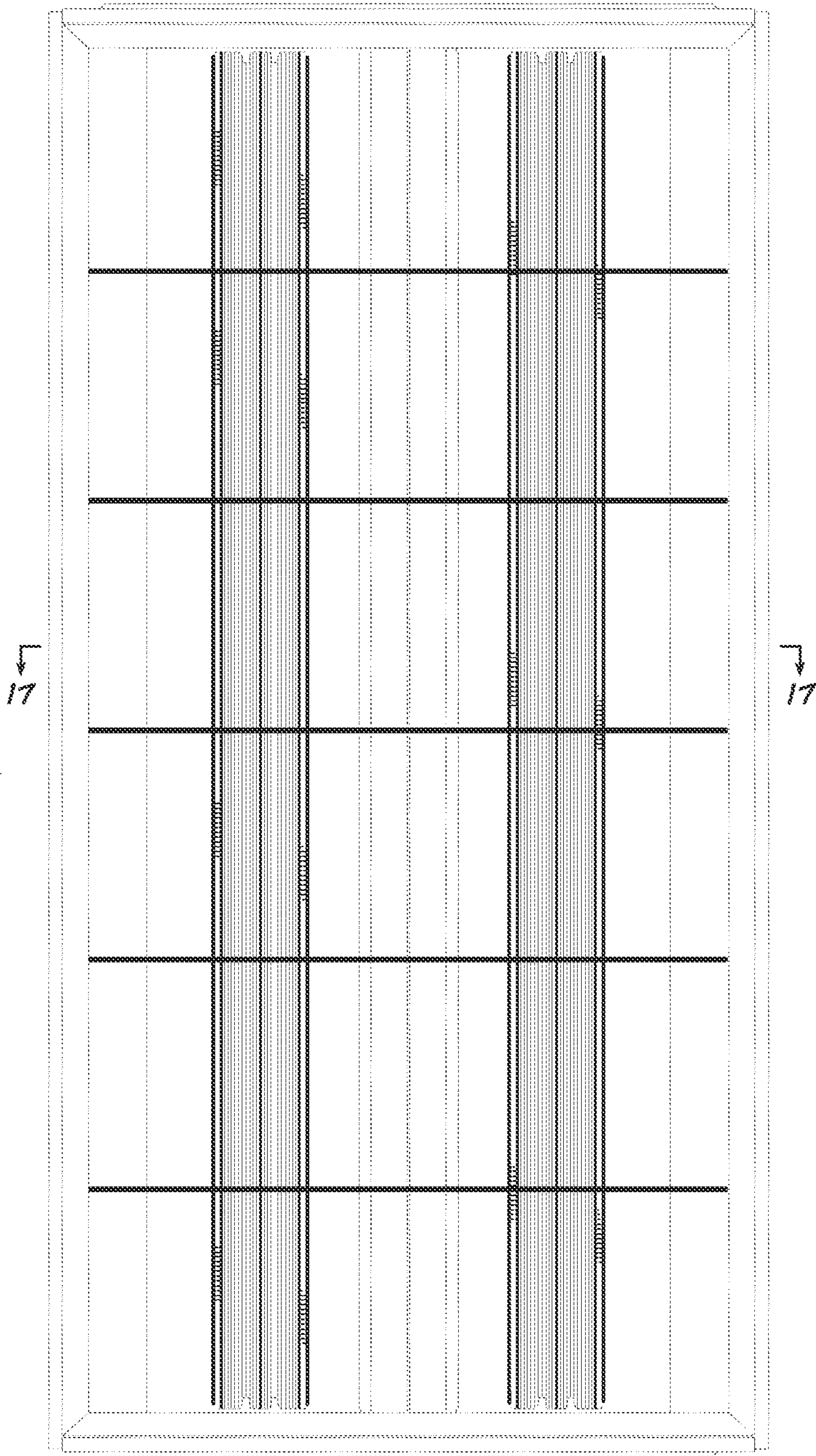
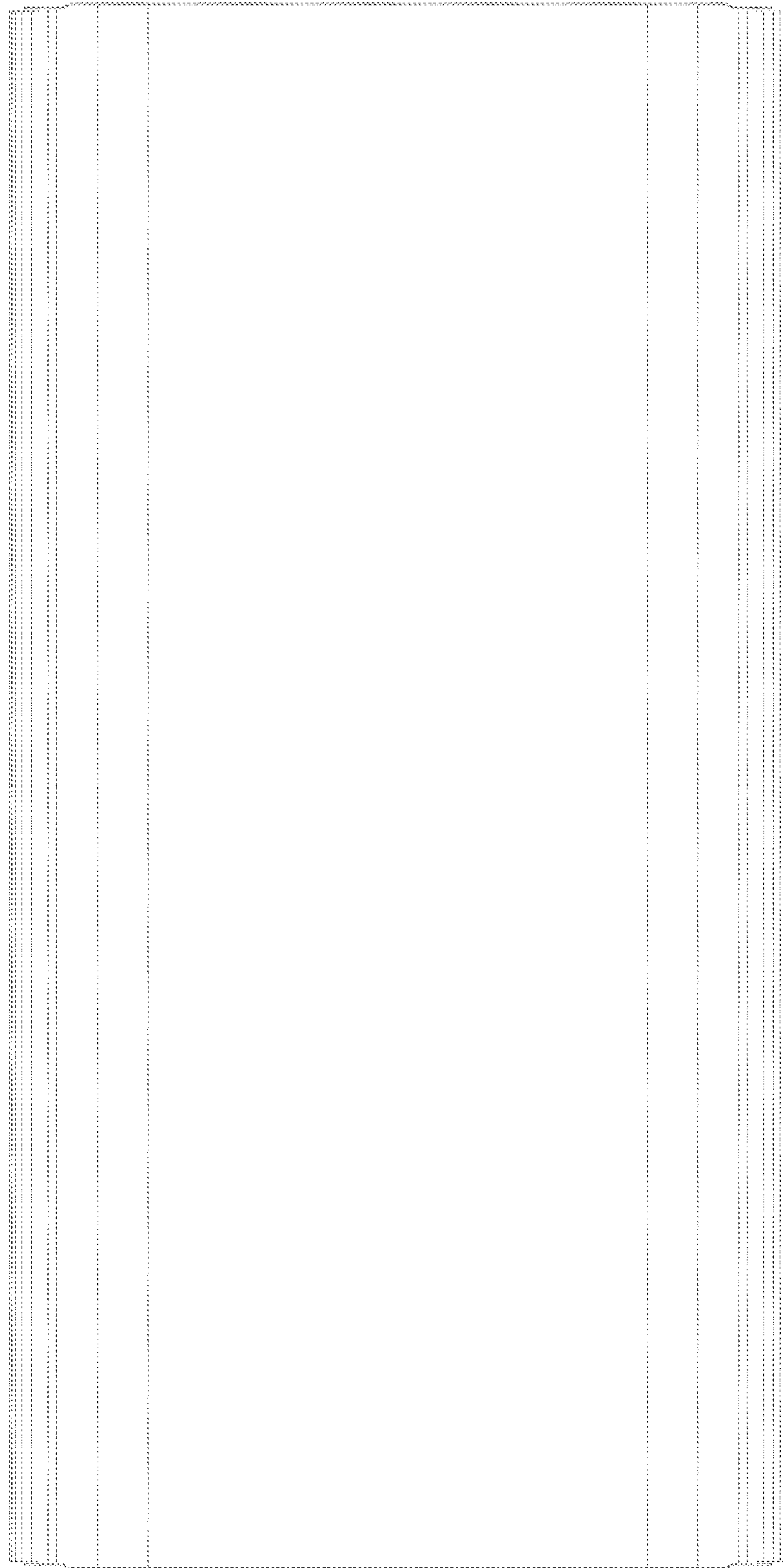

FIG. 12



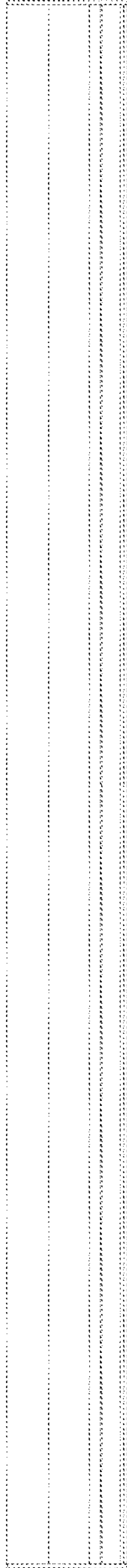

FIG. 13

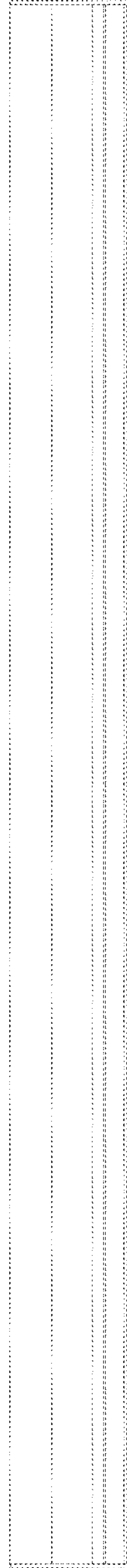

FIG. 14

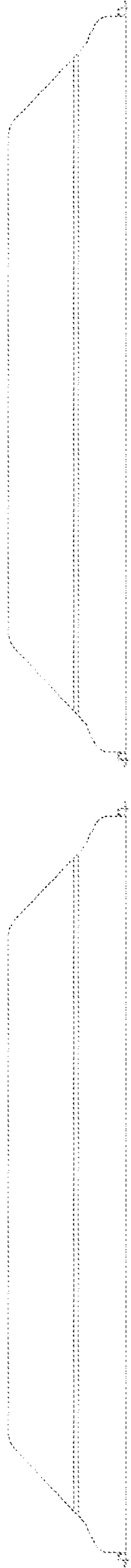

FIG. 15

FIG. 16

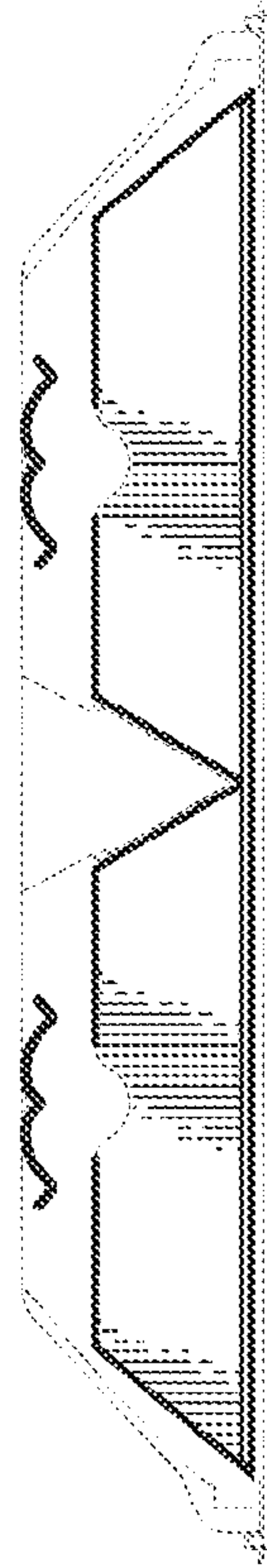

FIG. 17

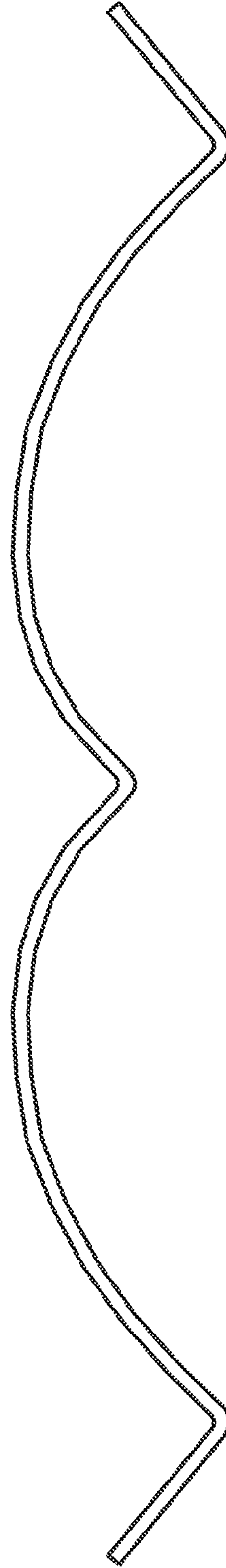

FIG. 18

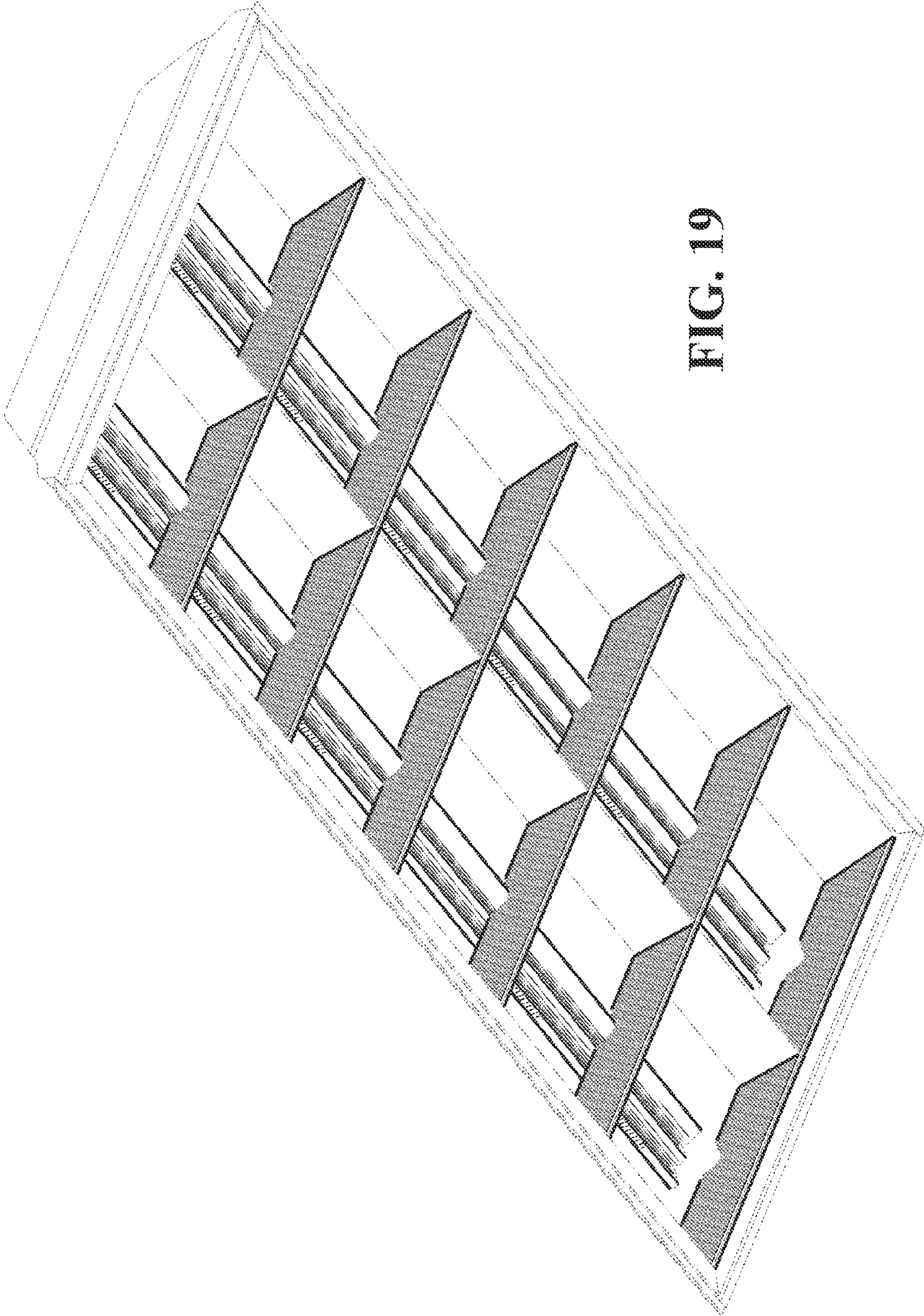

FIG. 19

FIG. 20

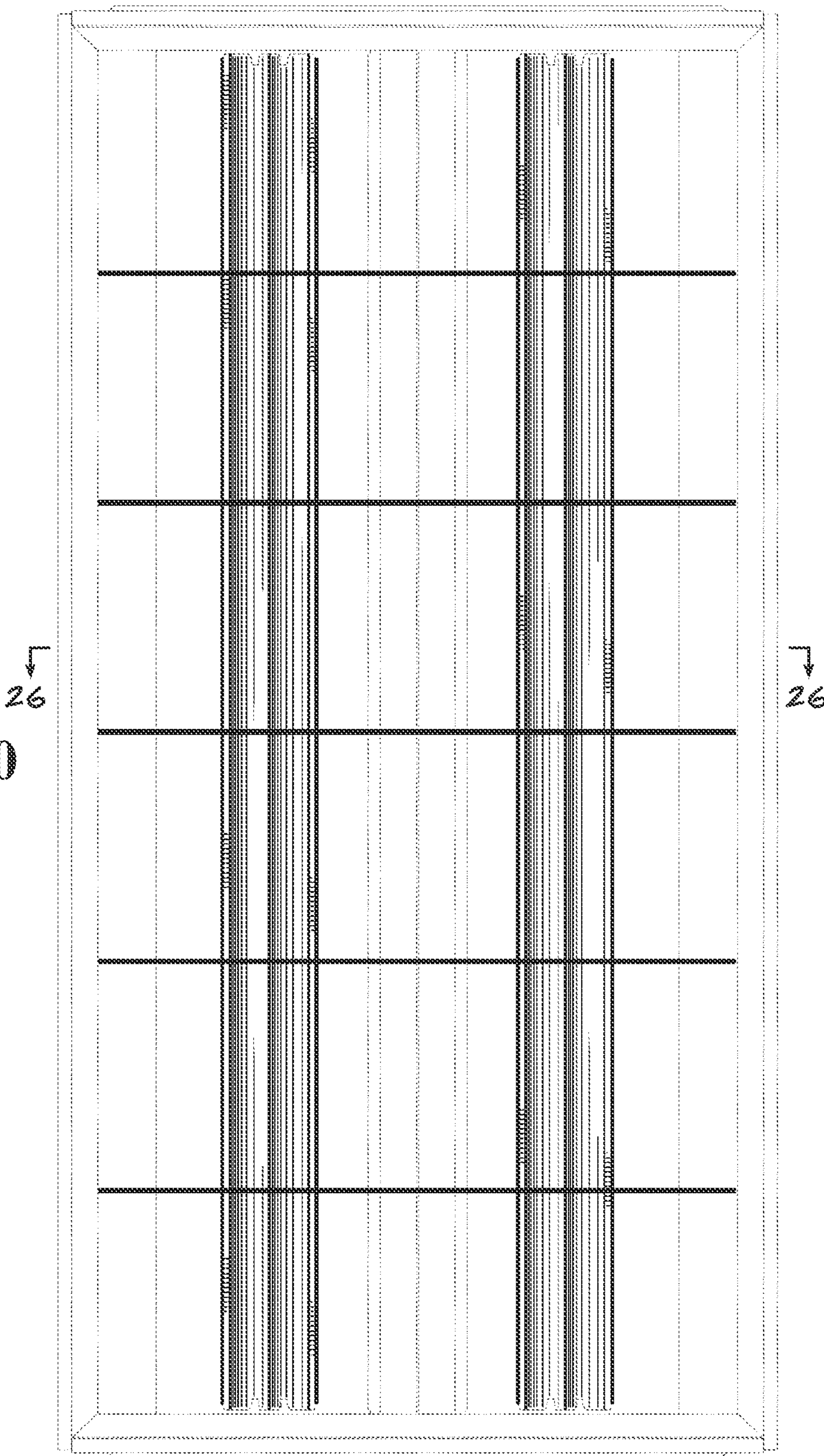
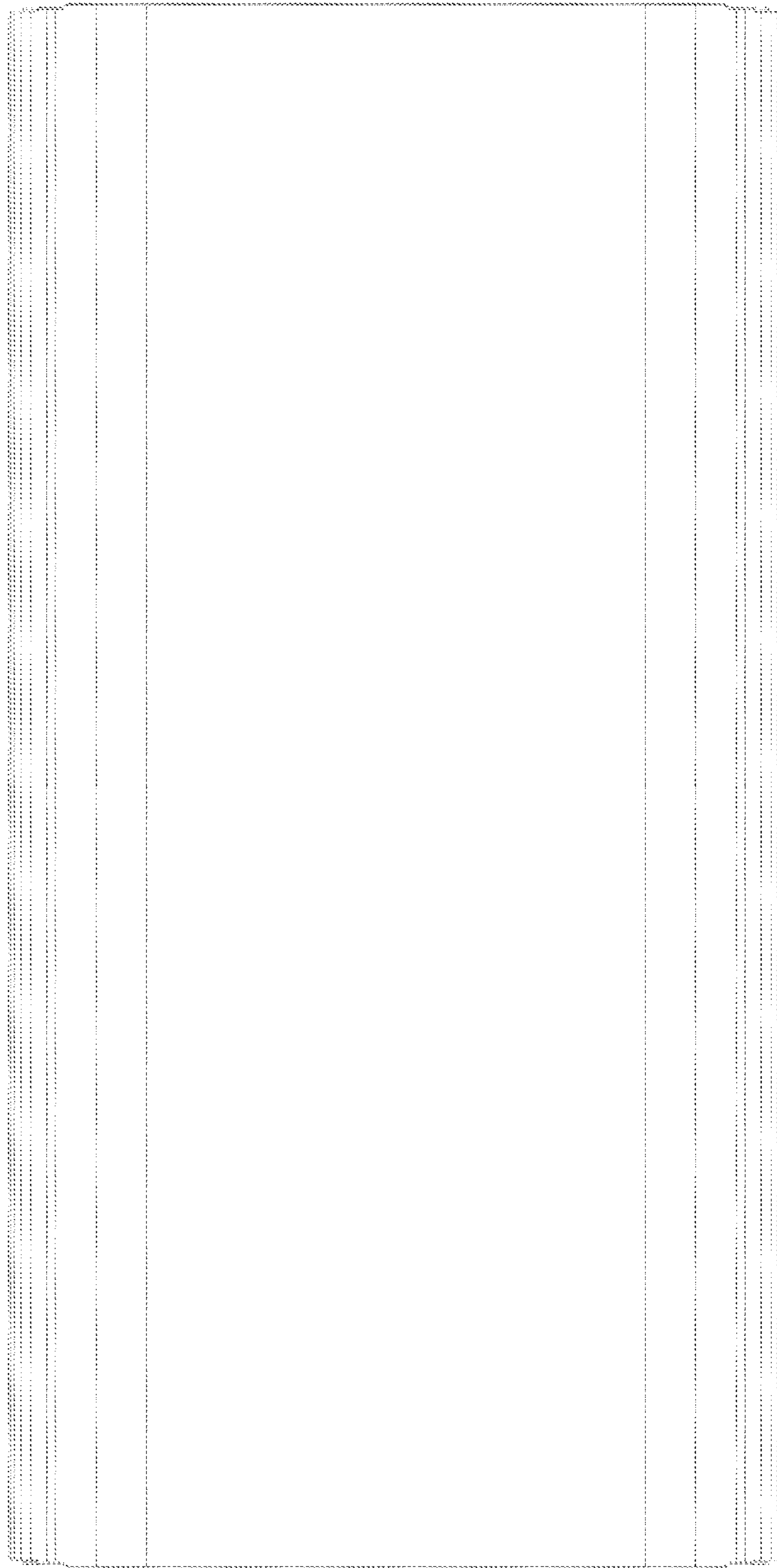

FIG. 21



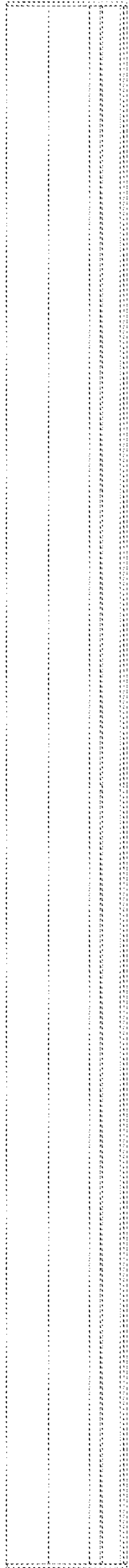

FIG. 22

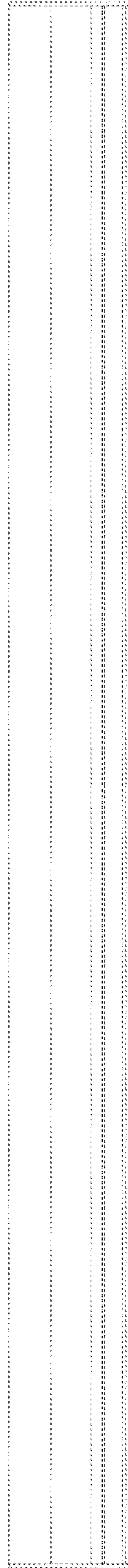

FIG. 23

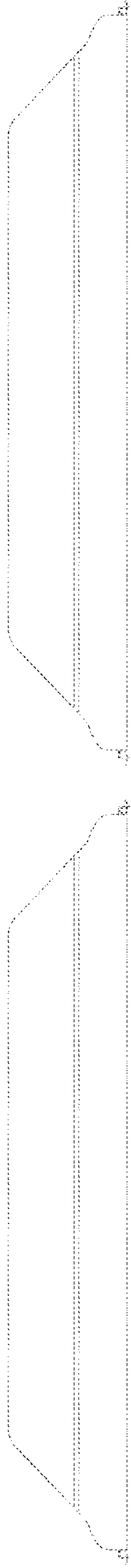

FIG. 24

FIG. 25

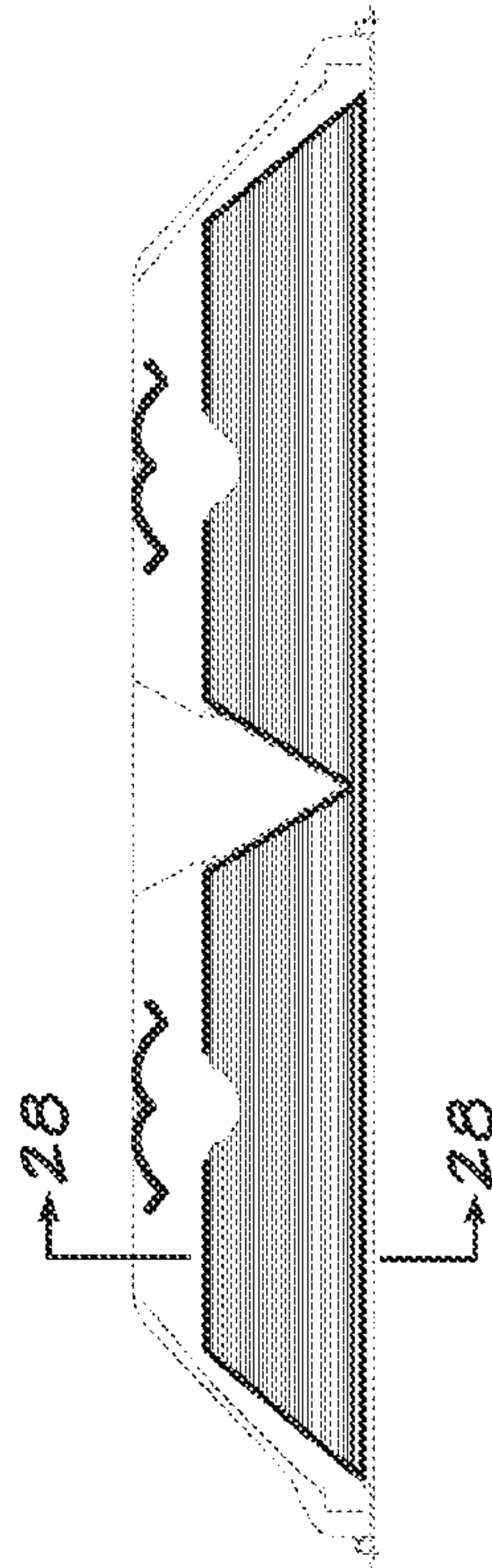
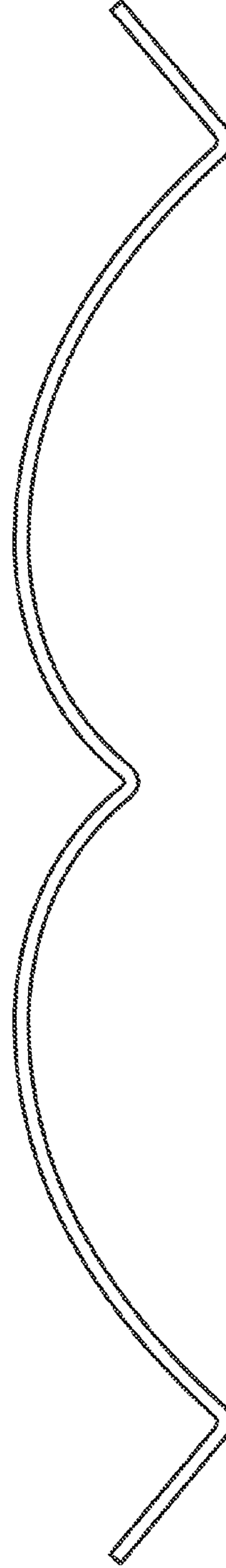

FIG. 26



FIG. 27

FIG. 28



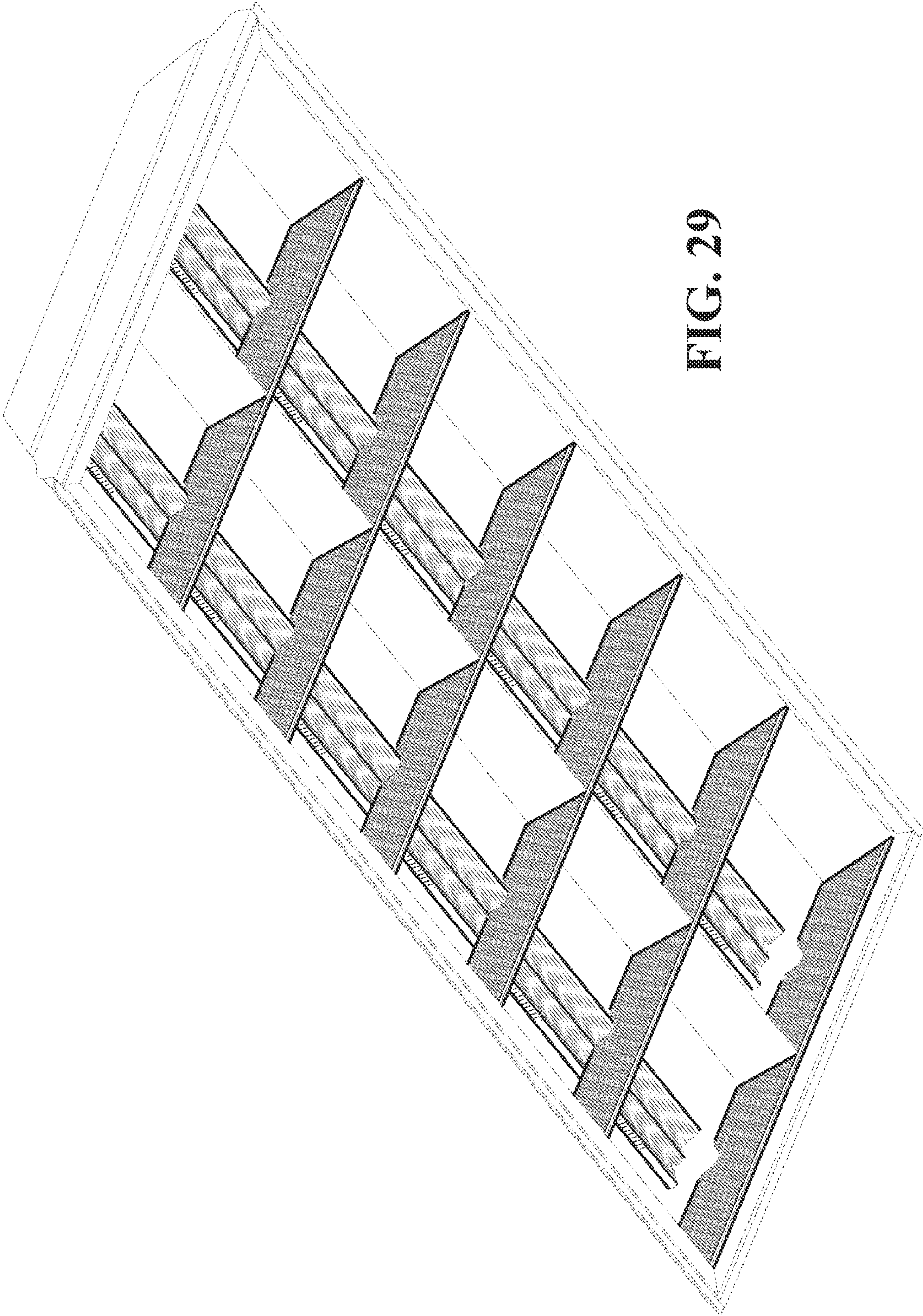

FIG. 29

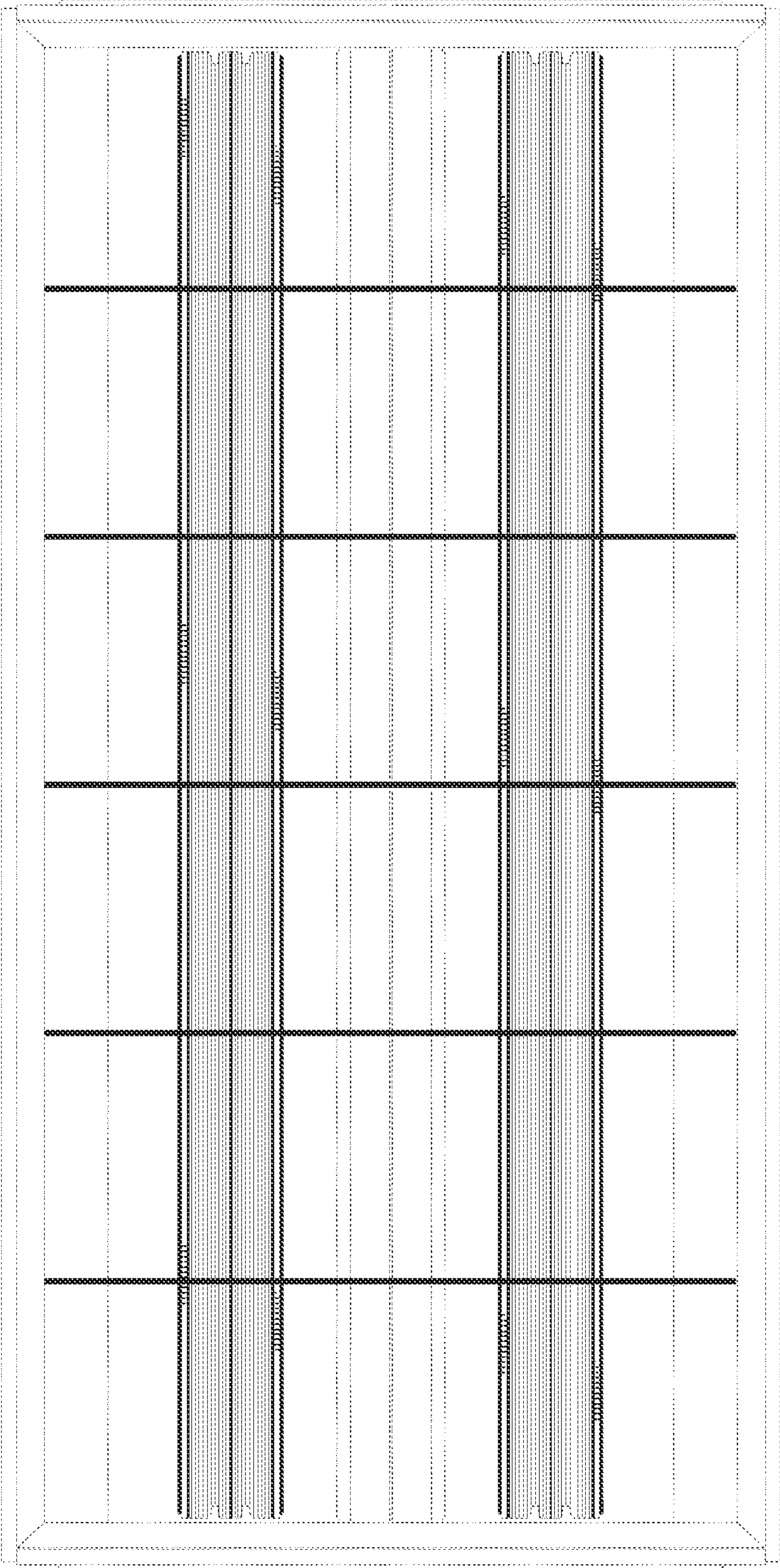

FIG. 30

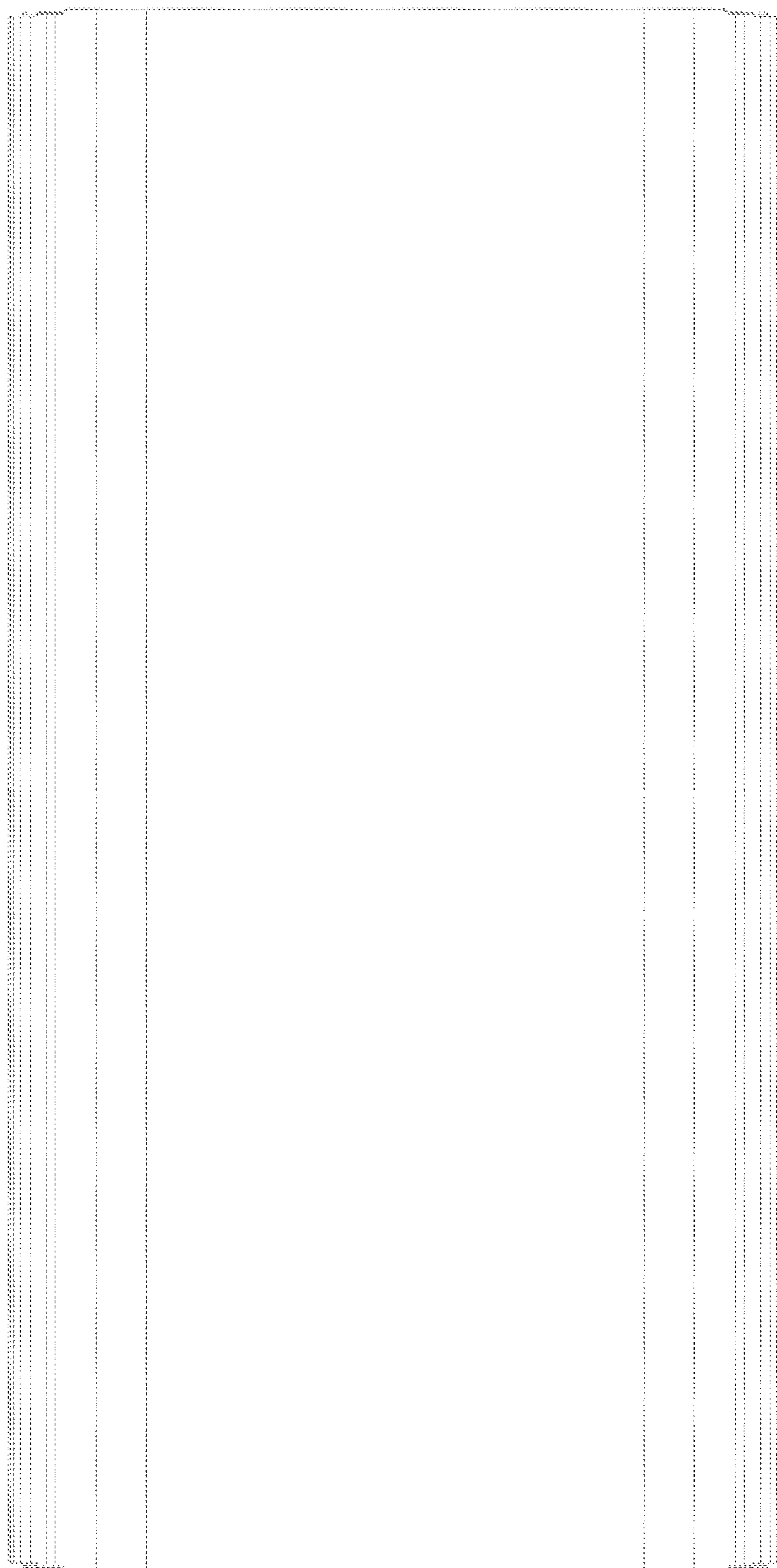

FIG. 31

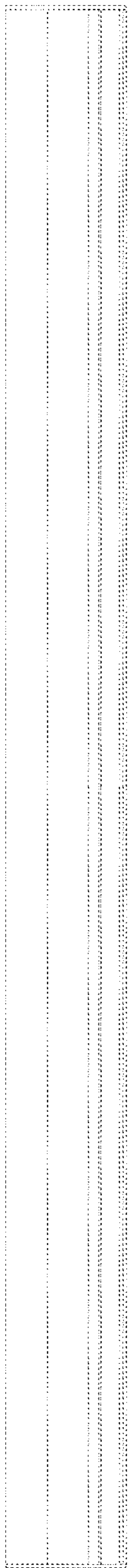

FIG. 32

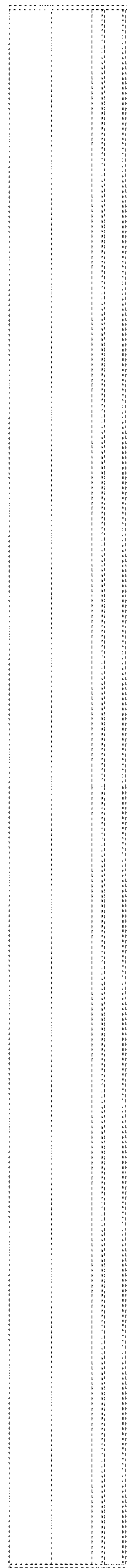

FIG. 33



FIG. 34

FIG. 35

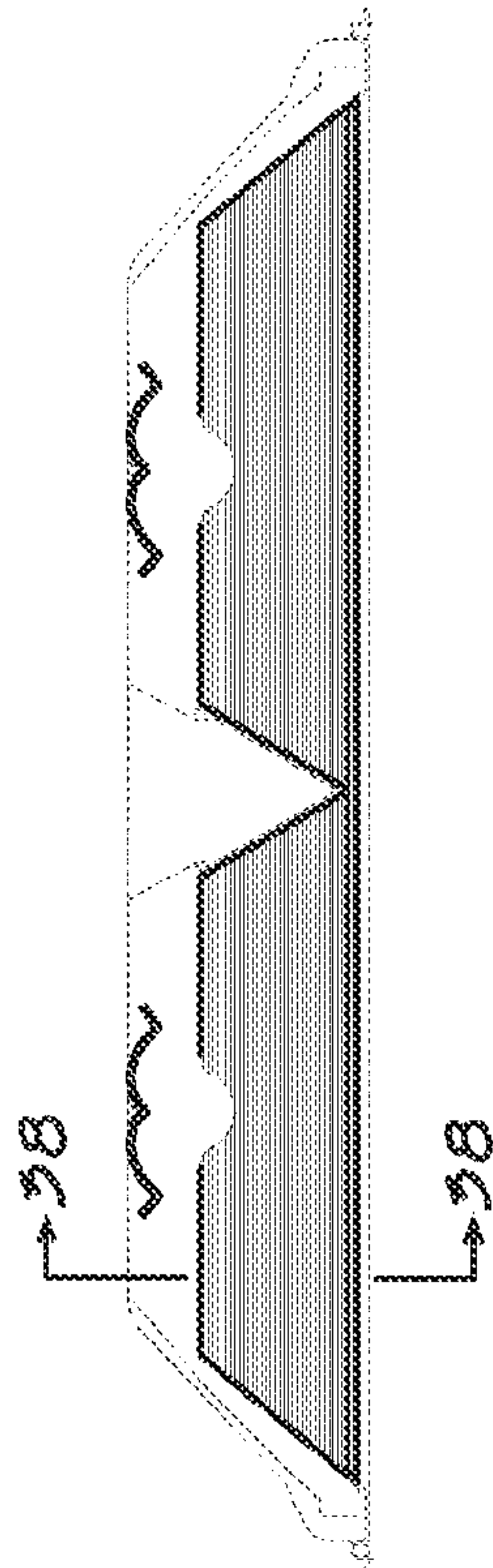

FIG. 36



FIG. 37

FIG. 38