



US00D678543S

(12) **United States Design Patent**
Shevin-Sandy

(10) **Patent No.:** **US D678,543 S**
(45) **Date of Patent:** **** Mar. 19, 2013**

(54) **CELLULITE MASSAGER AND SKIN SCRUBBER**

(75) Inventor: **Bonni Shevin-Sandy**, Morton Grove, IL (US)

(73) Assignee: **DARD Design International, LLC**, Skokie, IL (US)

(**) Term: **14 Years**

(21) Appl. No.: **29/404,940**

(22) Filed: **Oct. 26, 2011**

(51) **LOC (9) Cl.** **28-03**

(52) **U.S. Cl.** **D24/211**

(58) **Field of Classification Search** D24/200,
D24/211-215, 141; 601/27, 28, 33, 40, 46,
601/47, 48, 63, 80, 99, 104, 112, 113, 114,
601/119, 122, 125, 129, 134, 135, 137, DIG. 12,
601/DIG. 13, DIG. 14, DIG. 15, DIG. 16,
601/DIG. 17; D14/137, 147

See application file for complete search history.

(56) **References Cited**

U.S. PATENT DOCUMENTS

D202,006 S *	8/1965	Stiplav	D28/8.1
D261,428 S *	10/1981	Noble	D24/211
D262,908 S *	2/1982	Pesco	D24/211
D273,708 S *	5/1984	Haug	D24/211
D315,038 S *	2/1991	Strickler	D30/158
D387,482 S *	12/1997	Khan	D28/8.1
D419,680 S *	1/2000	Chen	D24/211
D423,677 S	4/2000	Sivan et al.		
D466,695 S *	12/2002	Chen	D4/120
6,511,445 B2	1/2003	Sivan et al.		
D485,010 S *	1/2004	Crawford	D28/8.1
D499,186 S *	11/2004	Chien	D24/211
D499,810 S *	12/2004	Chien	D24/211
D510,440 S *	10/2005	Huang	D24/211

D512,225 S *	12/2005	Chien	D4/120
D514,328 S *	2/2006	Huang	D4/121
7,041,072 B2	5/2006	Calvert		
D527,144 S *	8/2006	Crawford et al.	D28/8.1
D535,782 S *	1/2007	Caceres et al.	D28/8.1
D542,418 S *	5/2007	Chen	D24/211
D610,696 S *	2/2010	Makuch	D24/211
D668,385 S *	10/2012	Huljak et al.	D28/8.1

OTHER PUBLICATIONS

Website Screenshots: <http://cgi.ebay.com> Oriflame-Anti-Cellural Massager (Jun. 28, 2011).

* cited by examiner

Primary Examiner — Sandra Snapp

(74) *Attorney, Agent, or Firm* — The Soni Law Firm

(57) **CLAIM**

The ornamental design for the cellulite massager and skin scrubber, as shown and described.

DESCRIPTION

A portion of the disclosure of this patent document contains material to which a claim for copyright is made. The copyright owner has no objection to the facsimile reproduction by anyone of the patent document or the patent disclosure, as it appears in the Patent and Trademark Office patent file or records, but reserves all other copyright rights whatsoever.

FIG. 1 is a top side perspective view of the cellulite massager and skin scrubber showing my new design;

FIG. 2 is a front elevational view thereof;

FIG. 3 is a rear elevational view thereof;

FIG. 4 is a left side elevational view thereof;

FIG. 5 is a right side elevational view thereof;

FIG. 6 is a top plan view thereof; and,

FIG. 7 is a bottom plan view thereof.

1 Claim, 4 Drawing Sheets

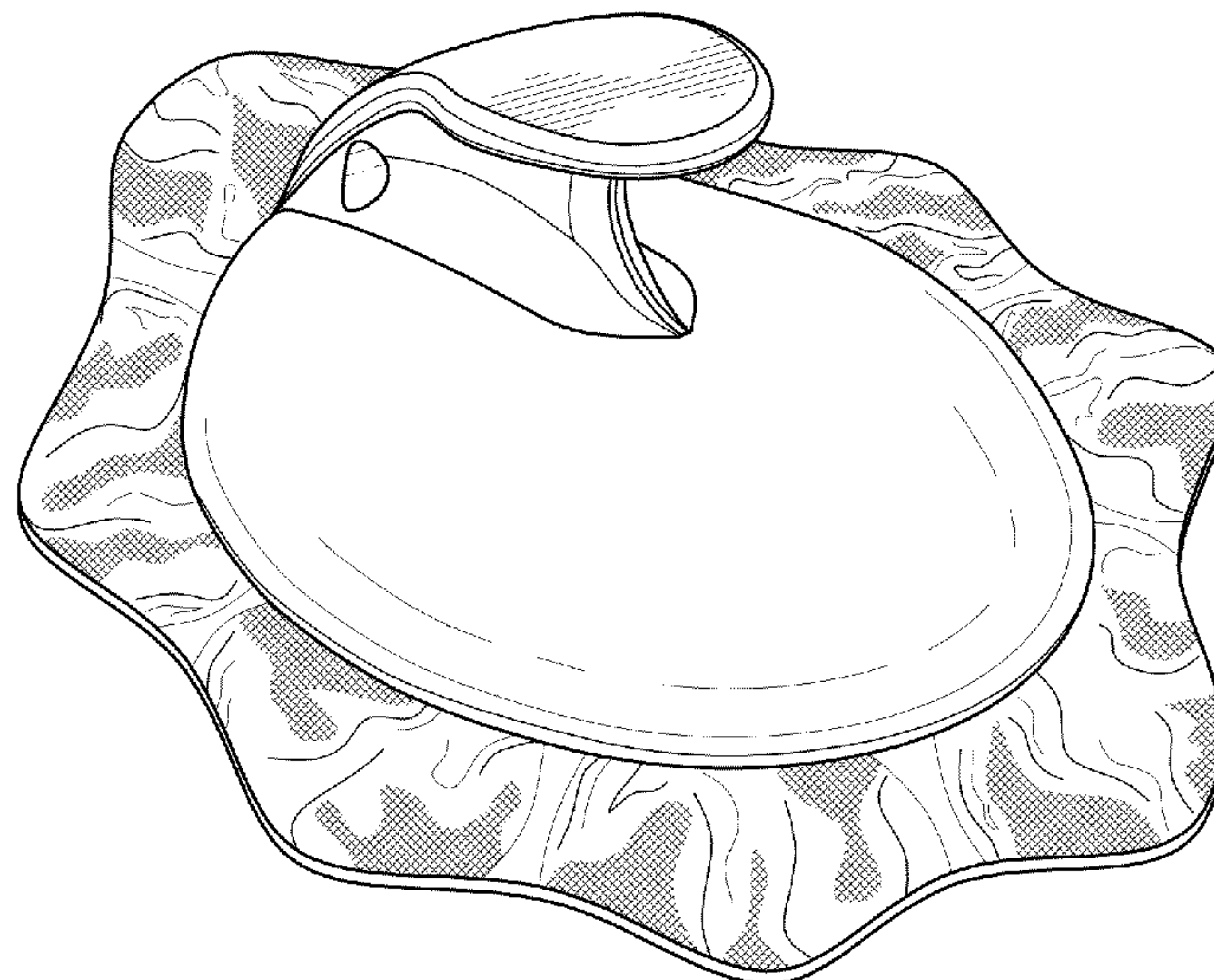

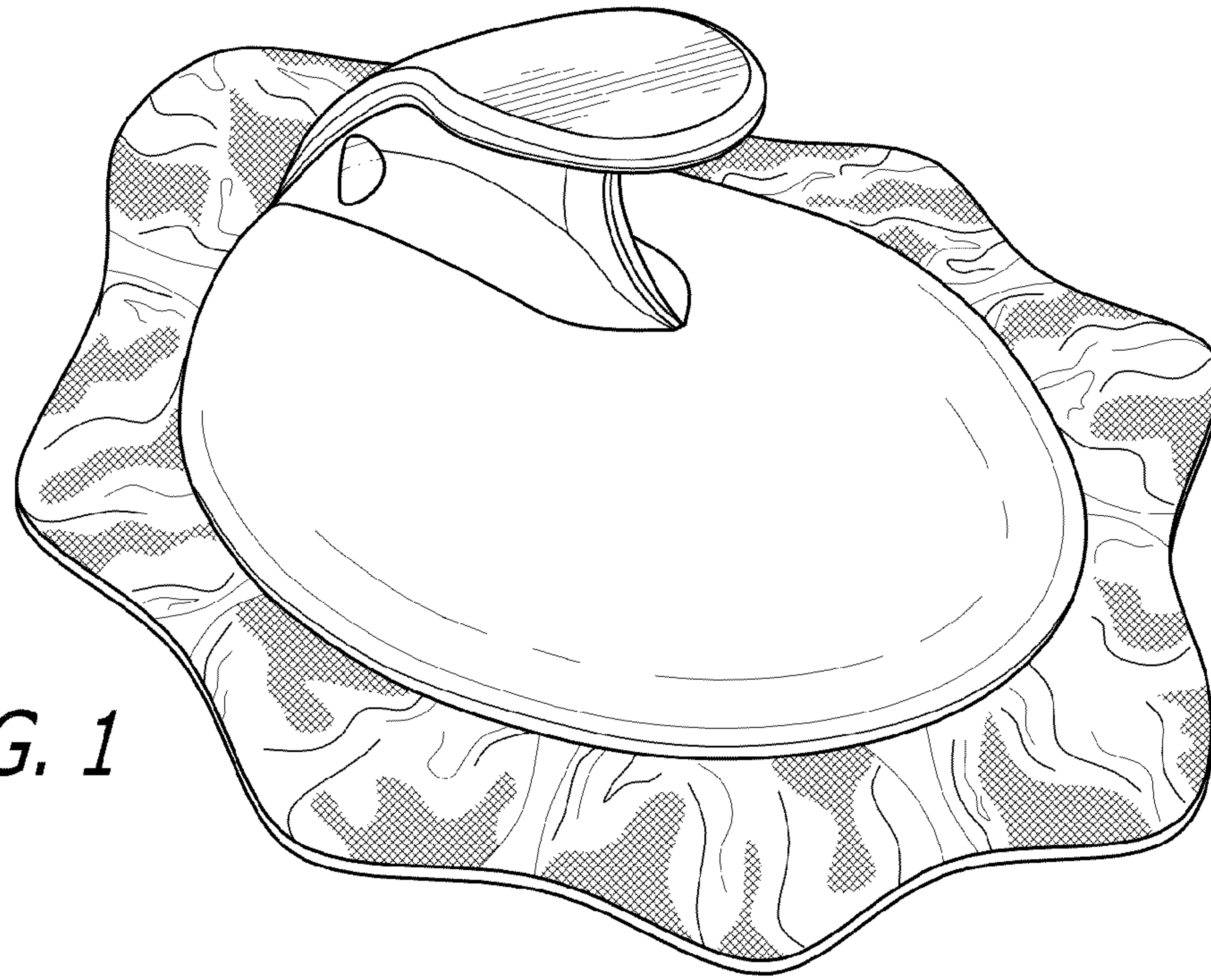

FIG. 1

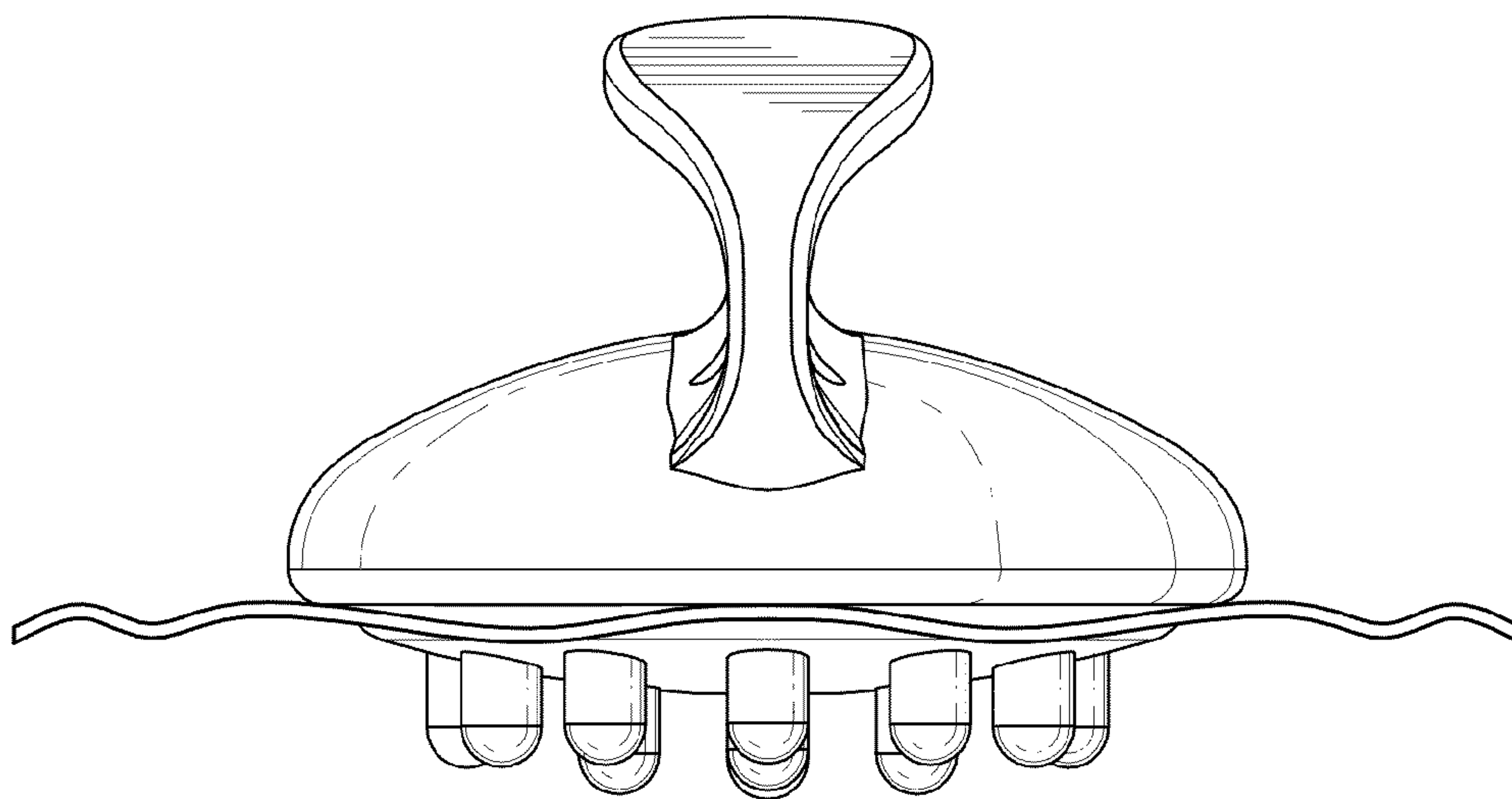

FIG. 2

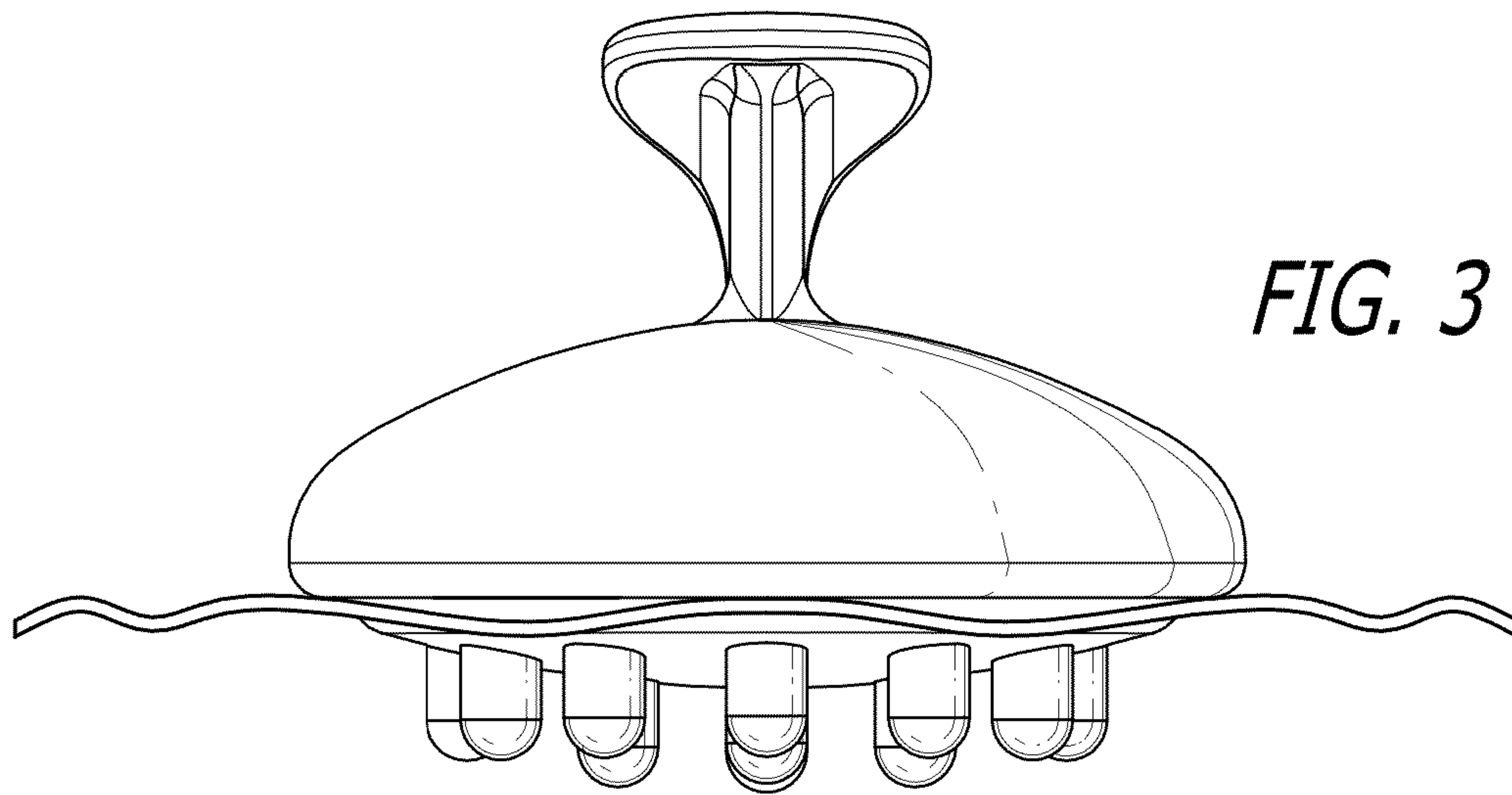

FIG. 3

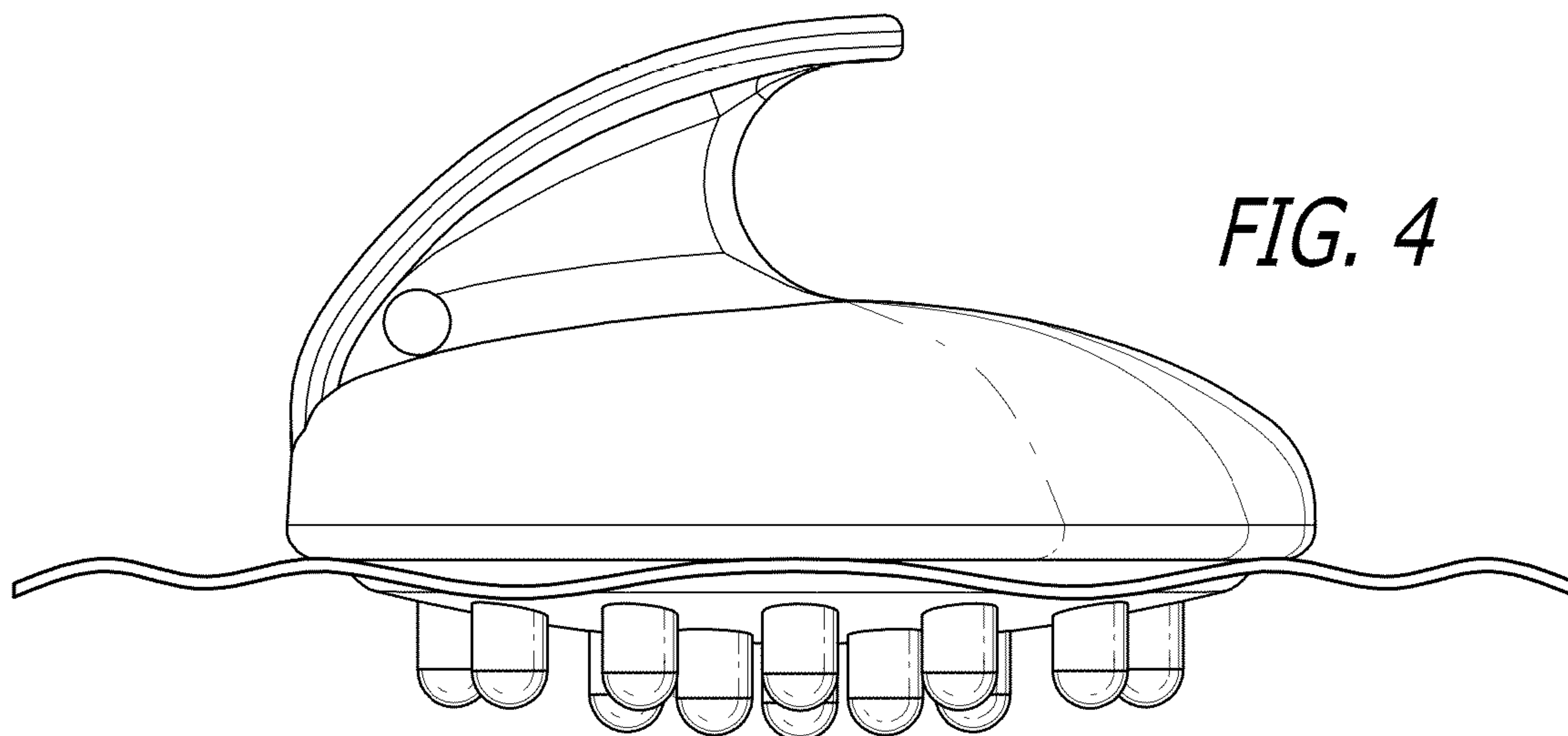
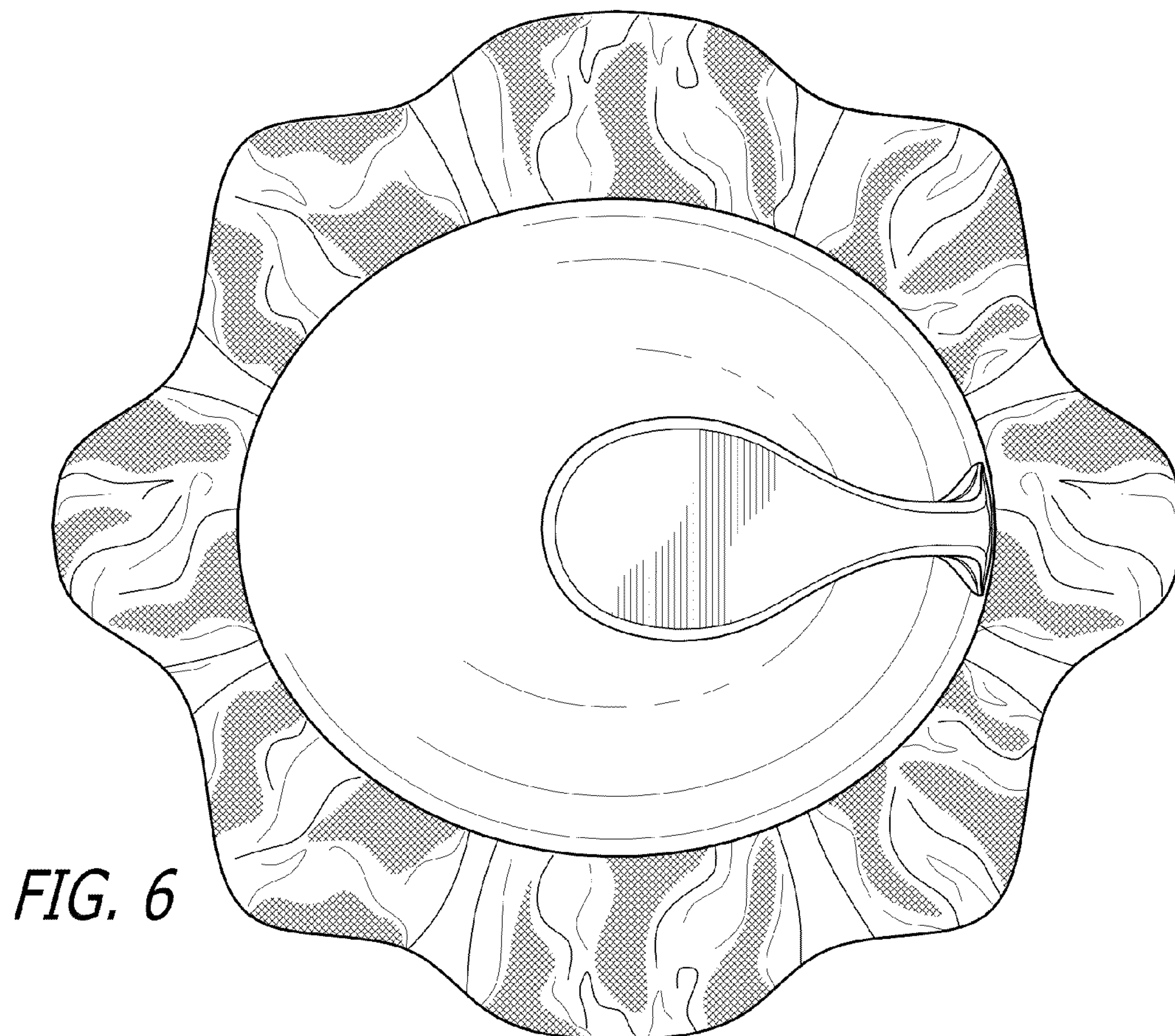
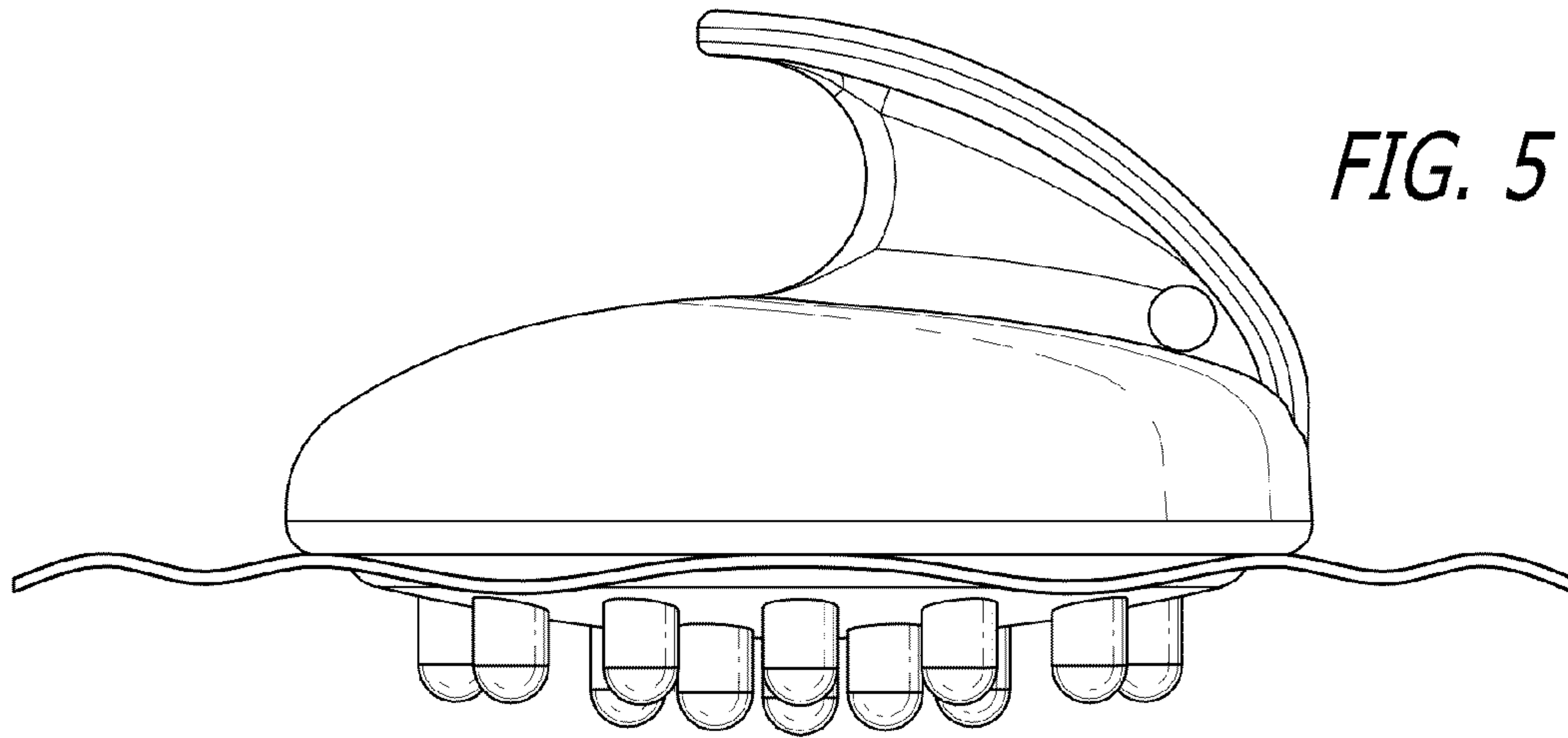

FIG. 4



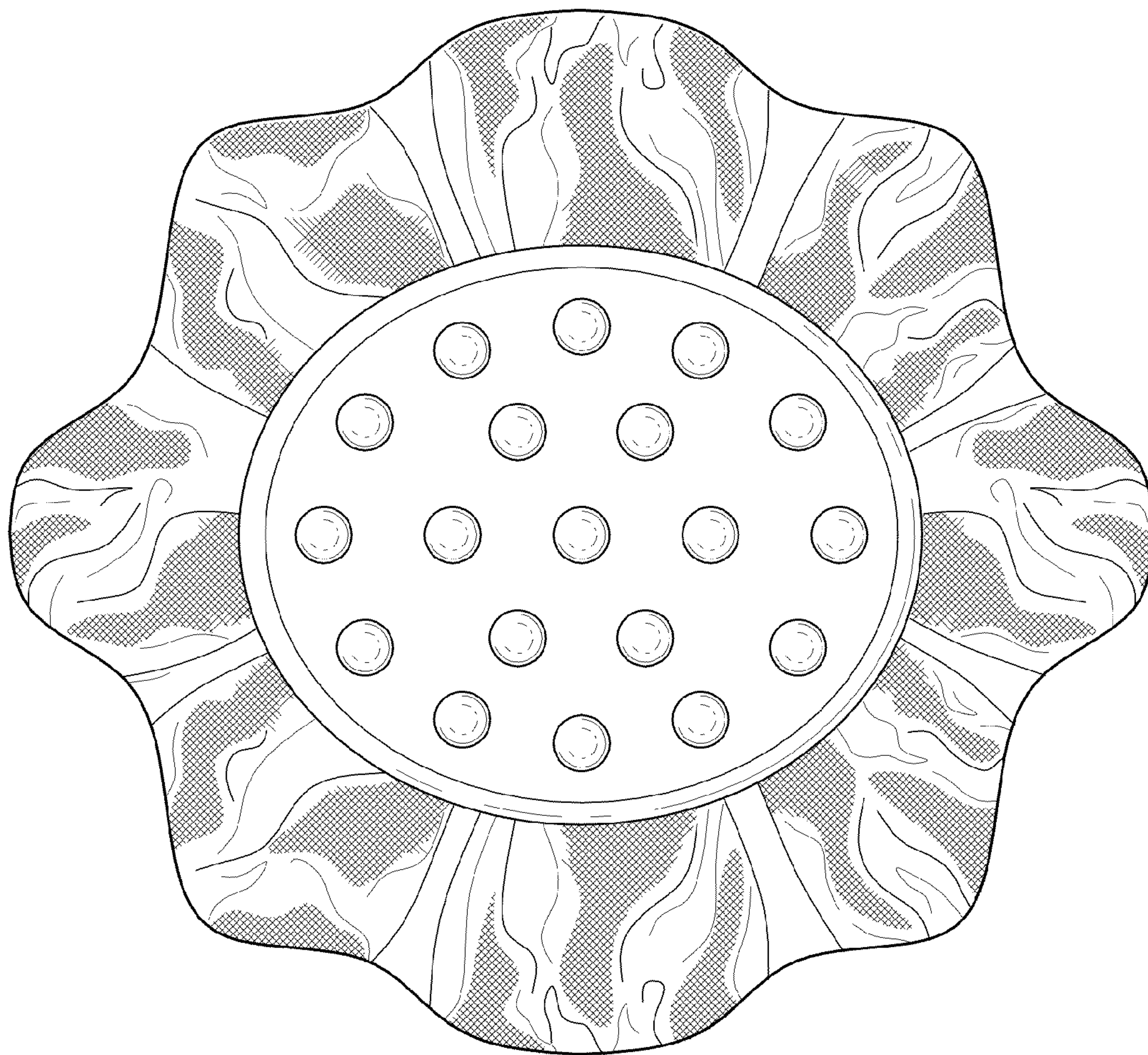

FIG. 7