



US00D678523S

(12) **United States Design Patent**
Shibao et al.

(10) **Patent No.:** **US D678,523 S**
(45) **Date of Patent:** **** Mar. 19, 2013**

(54) **ACCESS DEVICE FOR ENDOSCOPIC SURGERY**

(75) Inventors: **Kazunori Shibao**, Fukuoka (JP);
Yukihiko Tamai, Nagano (JP); **Kikuko Noguchi**, Nagano (JP)

(73) Assignees: **Kazunori Shibao**, Kitakyushu-shi (JP);
Hakko Co., Ltd., Chikuma-shi (JP)

(**) Term: **14 Years**

(21) Appl. No.: **29/408,000**

(22) Filed: **Dec. 6, 2011**

(51) **LOC (9) Cl.** **24-02**

(52) **U.S. Cl.** **D24/135**

(58) **Field of Classification Search** D24/135,
D24/133, 140; 600/201, 204, 208, 235; 604/93.01,
604/171-177

See application file for complete search history.

(56) **References Cited**

U.S. PATENT DOCUMENTS

5,741,298 A * 4/1998 MacLeod 606/213
6,142,935 A * 11/2000 Flom et al. 600/206
D634,841 S * 3/2011 Tao D24/135

(Continued)

FOREIGN PATENT DOCUMENTS

JP 3062106 U 9/1999
JP 1066209 D 1/2000
JP 1167097 D 1/2003
JP 1167098 D 1/2003
JP 1169231 D 2/2003
JP 1182908 D 7/2003
JP 1182909 D 7/2003

(Continued)

Primary Examiner — Bridget L Eland

(74) *Attorney, Agent, or Firm* — Foley & Lardner LLP

(57) **CLAIM**

We claim the ornamental design for an access device for endoscopic surgery, as shown and described.

DESCRIPTION

FIG. 1 is a front view of an access device for endoscopic surgery showing our new design; FIG. 2 is a top plan view thereof; FIG. 3 is a bottom plan view thereof; FIG. 4 is a right side view thereof; FIG. 5 is a left side view thereof; FIG. 6 is a back view thereof; FIG. 7 is a perspective view thereof; FIG. 8 is a front view of a port unit of the access device for endoscopic surgery shown removed from the retractor unit in order to show aspects of the design otherwise not shown; FIG. 9 is a top plan view thereof; FIG. 10 is a bottom plan view thereof; FIG. 11 is a right side view thereof; FIG. 12 is a left side view thereof; FIG. 13 is a back view thereof; FIG. 14 is a perspective view thereof; FIG. 15 is a front view of a retractor unit of the access device for endoscopic surgery shown removed from the port unit in order to show aspects of the design otherwise not shown; FIG. 16 is a top plan view thereof; FIG. 17 is a bottom plan view thereof; FIG. 18 is a left side view thereof; FIG. 19 is a perspective view thereof; and, FIG. 20 is an exploded view of the access device for endoscopic surgery showing our new design.

The ornamental design which is claimed is shown in solid lines in the drawings.

The evenly spaced broken lines are for illustrative purposes only, and do not form a part of the claimed design. Rather, these evenly spaced broken lines are directed to the environment of the claimed design.

The dash-dot lines in the drawings are for illustrative purposes only, and do not form a part of the claimed design. Rather, these dash-dot lines represent boundaries between areas that form a part of the claimed design and areas that do not form a part of the claimed design.

1 Claim, 20 Drawing Sheets

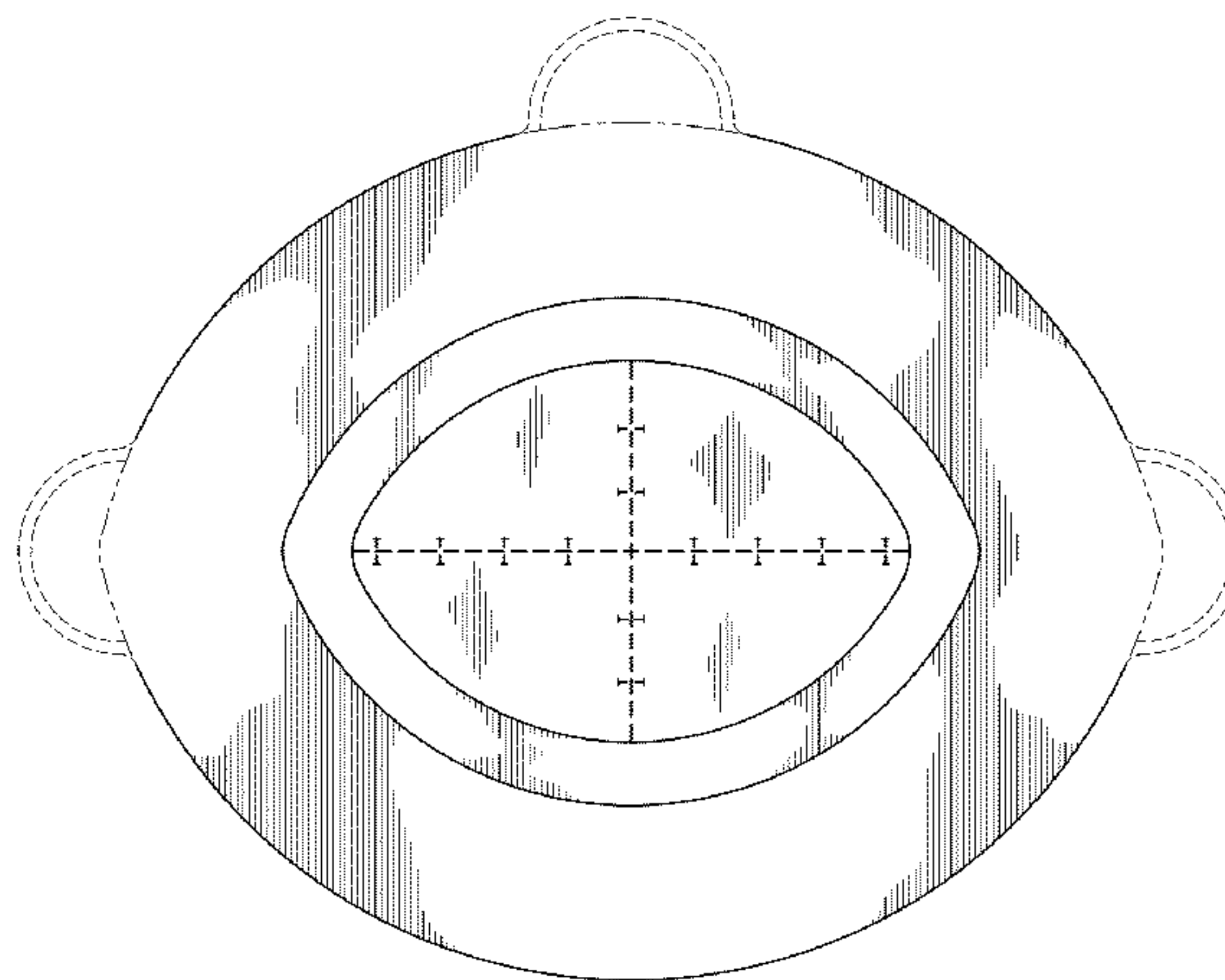
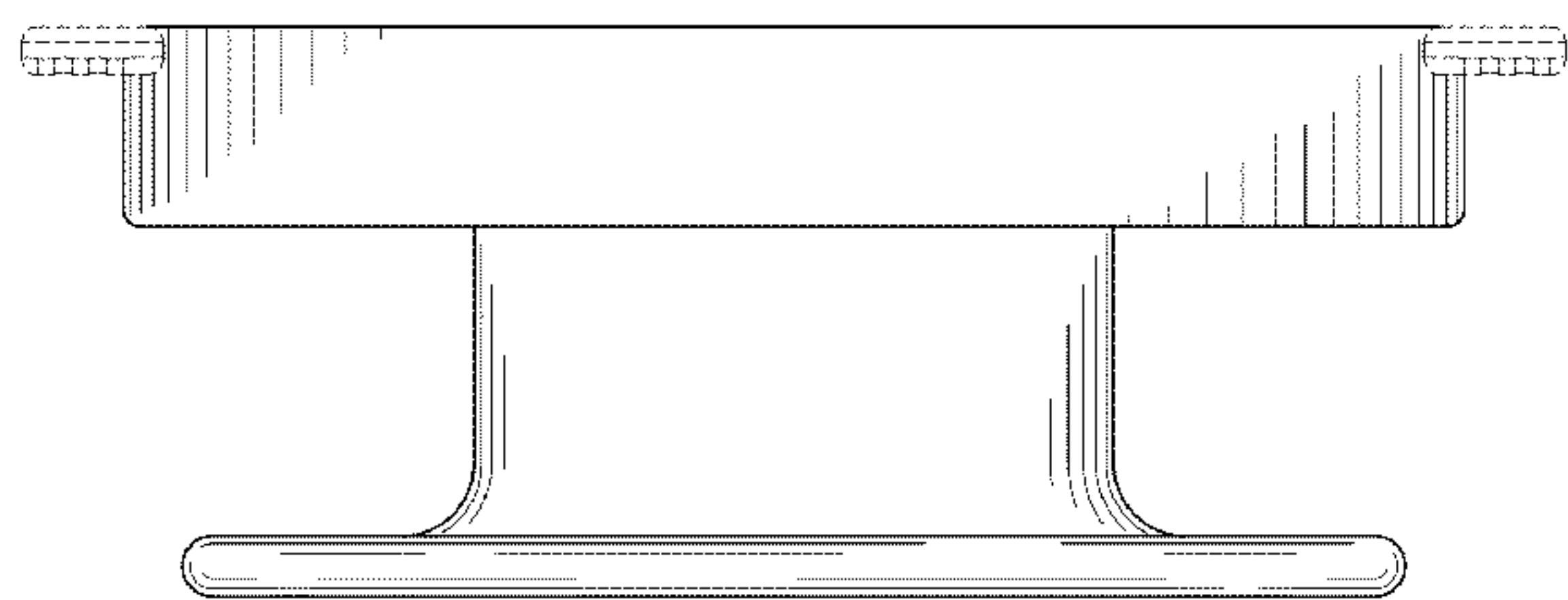

US D678,523 S

Page 2

U.S. PATENT DOCUMENTS

2004/0078004	A1 *	4/2004	Bourne et al.	604/174
2004/0242968	A1 *	12/2004	Hill et al.	600/210
2004/0267238	A1 *	12/2004	Haarala et al.	604/502
2009/0093752	A1	4/2009	Richard et al.	
2009/0187079	A1	7/2009	Albrecht et al.	
2009/0221966	A1	9/2009	Richard	
2009/0227843	A1 *	9/2009	Smith et al.	600/208
2010/0041957	A1 *	2/2010	Urano et al.	600/236
2010/0081880	A1	4/2010	Widenhouse et al.	
2010/0094227	A1	4/2010	Albrecht et al.	
2010/0100043	A1	4/2010	Racenet	
2010/0113882	A1	5/2010	Widenhouse et al.	
2010/0228091	A1	9/2010	Widenhouse et al.	
2010/0228092	A1	9/2010	Ortiz et al.	
2010/0249516	A1	9/2010	Shelton, IV et al.	
2010/0249520	A1	9/2010	Shelton, IV et al.	
2010/0249521	A1	9/2010	Shelton, IV et al.	
2010/0249525	A1	9/2010	Shelton, IV et al.	
2010/0249526	A1	9/2010	Shelton, IV et al.	
2010/0286484	A1	11/2010	Stellon et al.	
2010/0298646	A1	11/2010	Stellon et al.	
2011/0034778	A1	2/2011	Kleyman	
2011/0034935	A1	2/2011	Kleyman	

2011/0034946	A1	2/2011	Kleyman
2011/0034947	A1	2/2011	Kleyman
2011/0066001	A1	3/2011	Shelton, IV et al.
2011/0251465	A1	10/2011	Kleyman

FOREIGN PATENT DOCUMENTS

JP	1182910 D	7/2003
JP	2009-101150 A	5/2009
JP	2009-207888 A	9/2009
JP	2010-082449 A	4/2010
JP	2010-104786 A	5/2010
JP	2010-207576 A	9/2010
JP	2010-207578 A	9/2010
JP	2010-240404 A	10/2010
JP	2010-259802 A	11/2010
JP	2010-269145 A	12/2010
JP	2011-36661 A	2/2011
JP	2011-509767 A	3/2011
JP	2011-218169 A	11/2011
JP	2011-245017 A	12/2011
JP	2012-19854 A	2/2012

* cited by examiner

FIG. 1

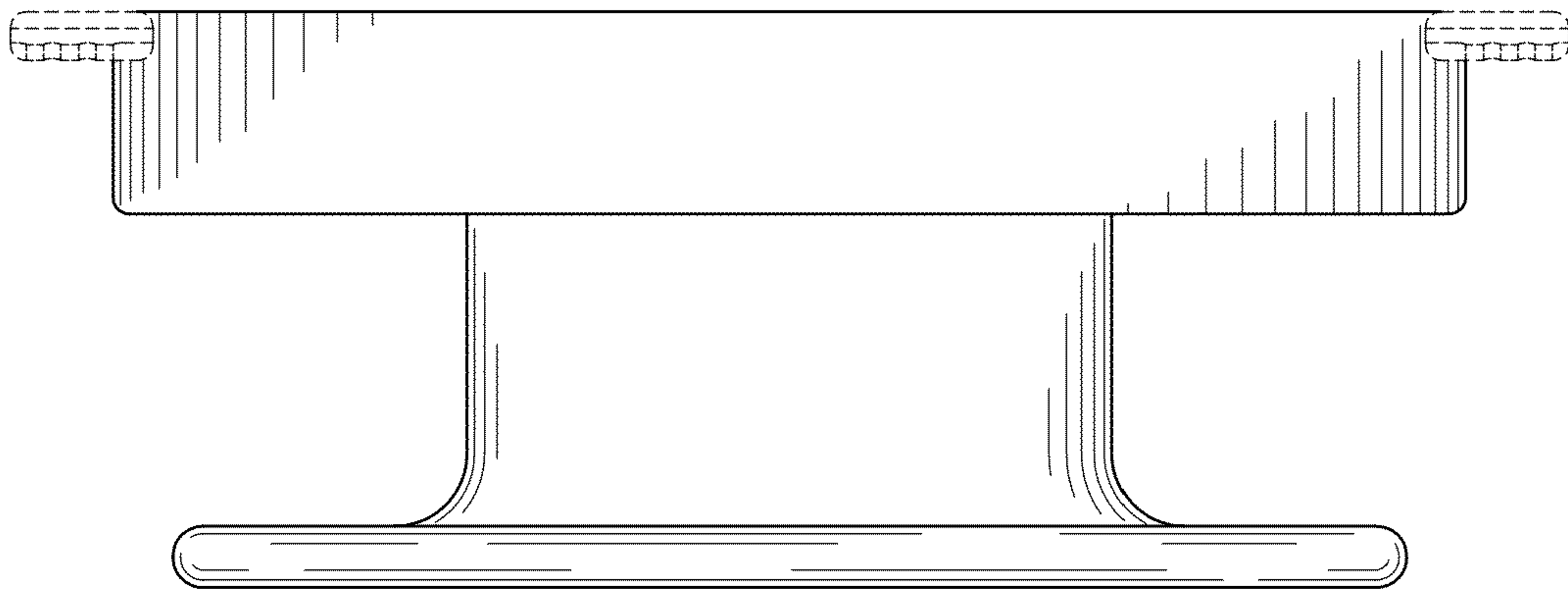

FIG. 2

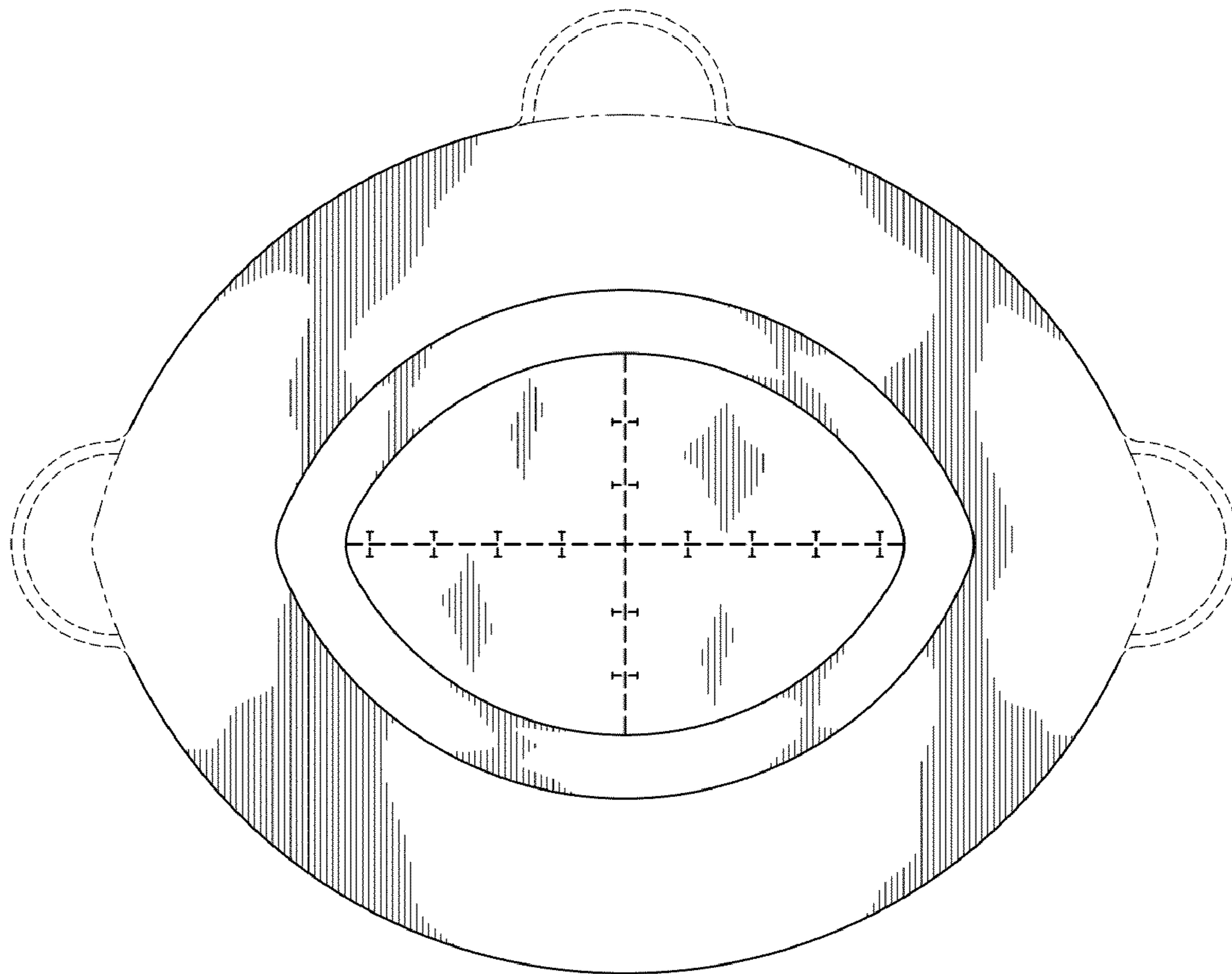

FIG. 3

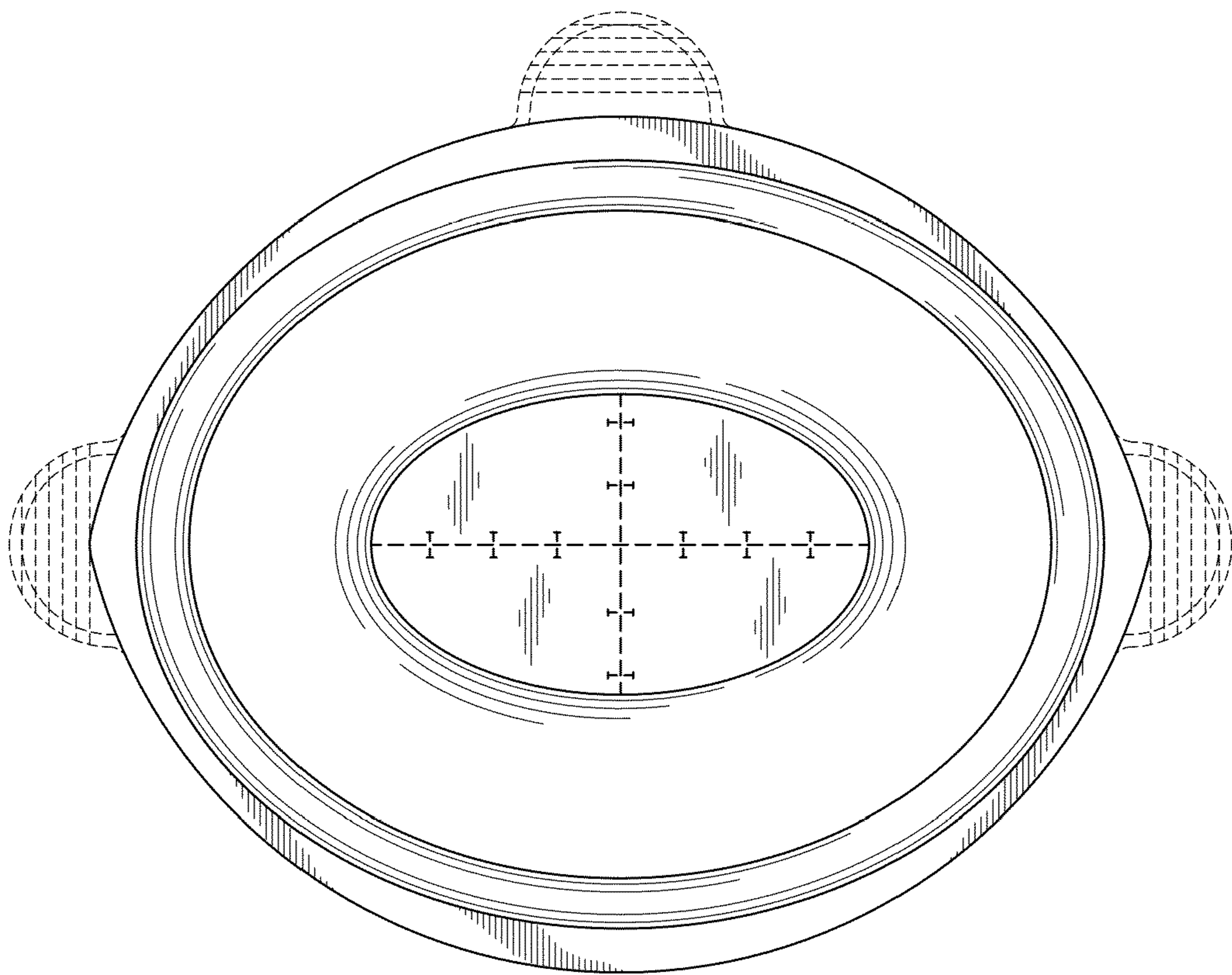

FIG. 4

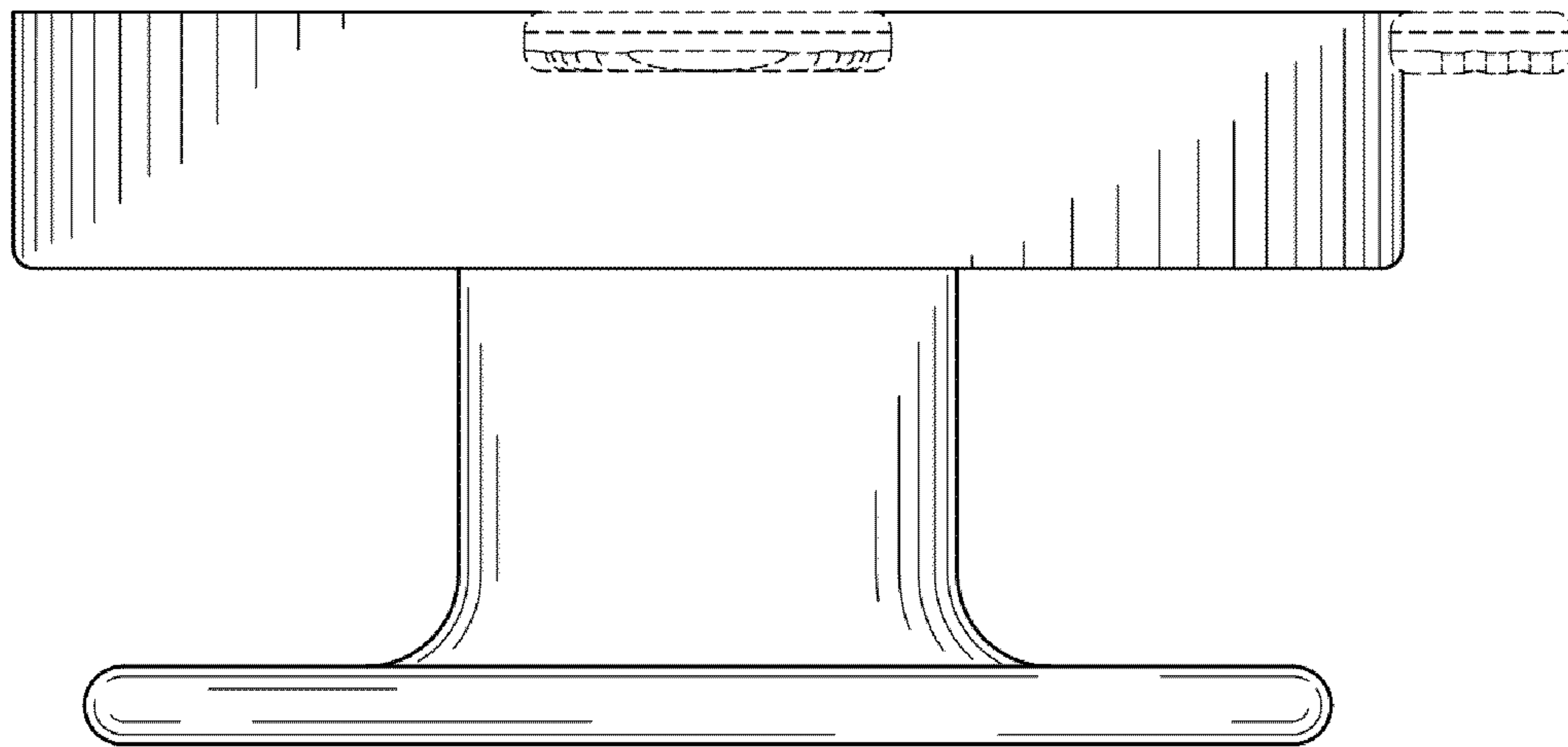

FIG. 5

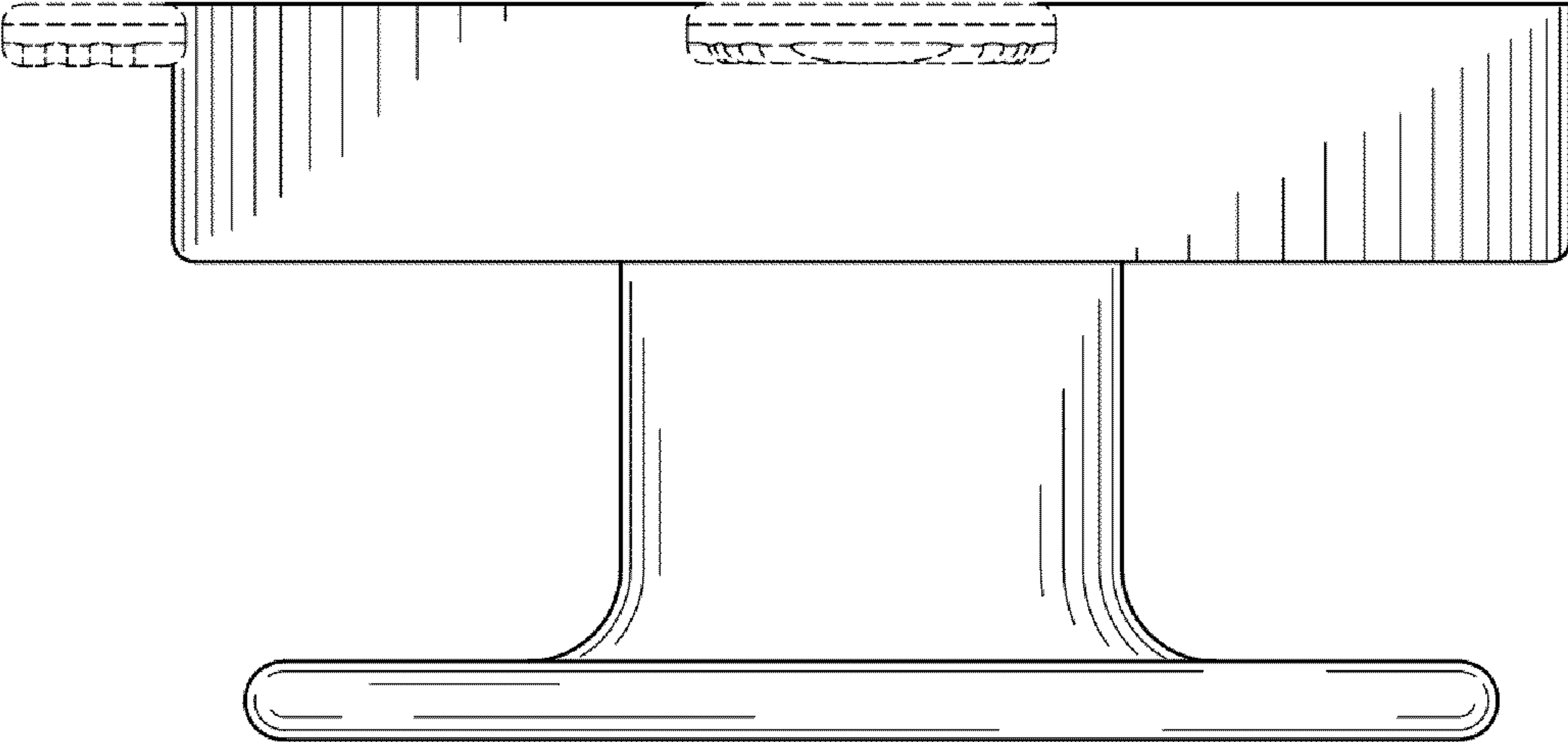

FIG. 6

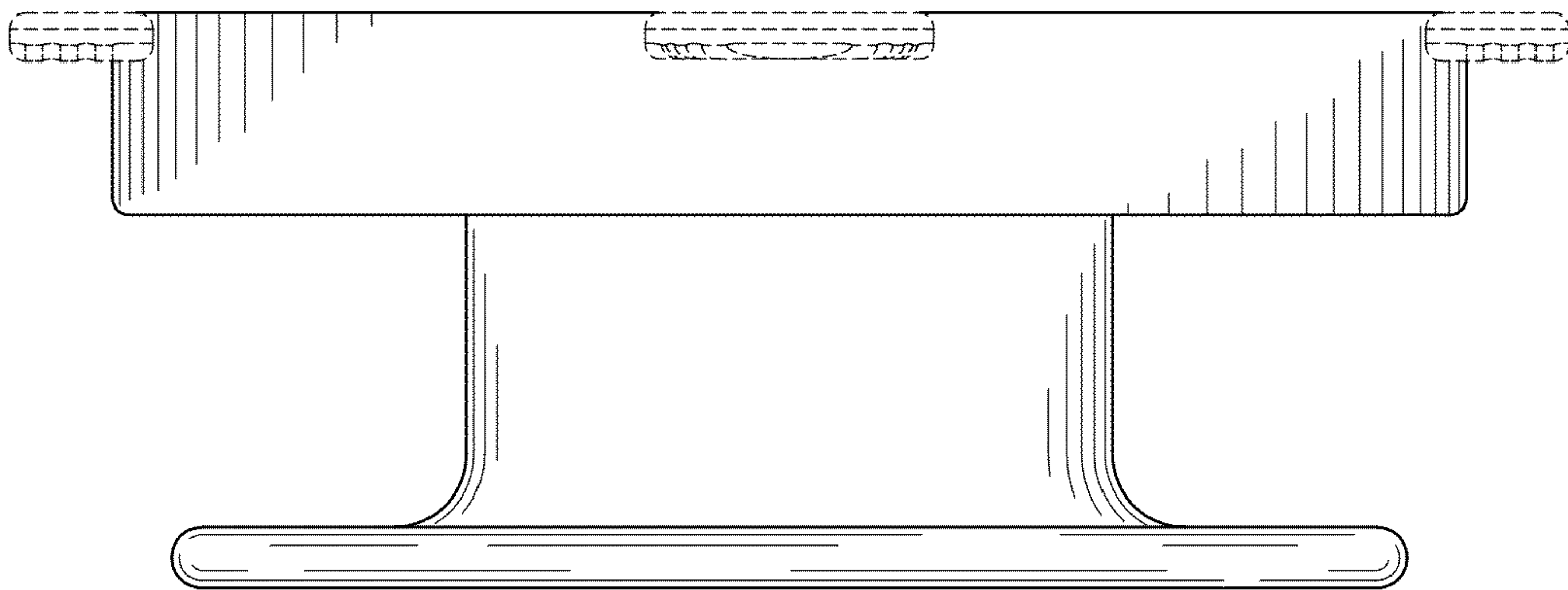

FIG. 7

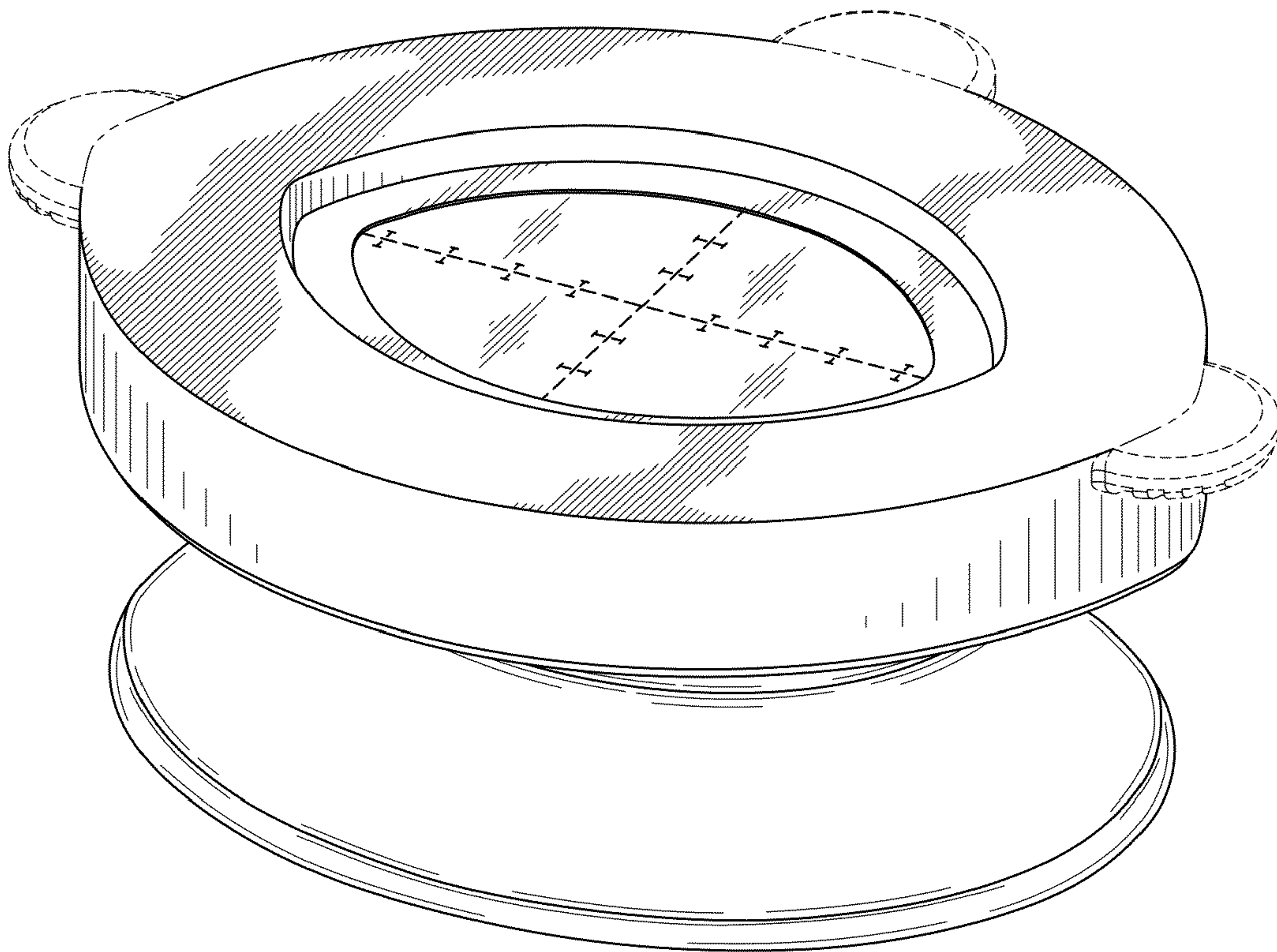

FIG. 8

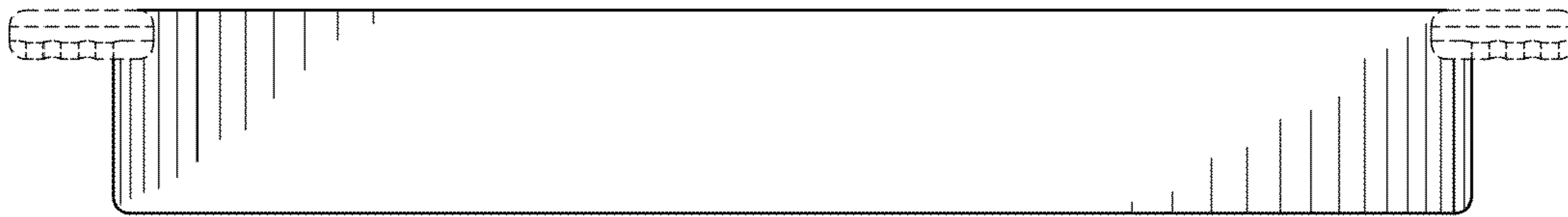

FIG. 9

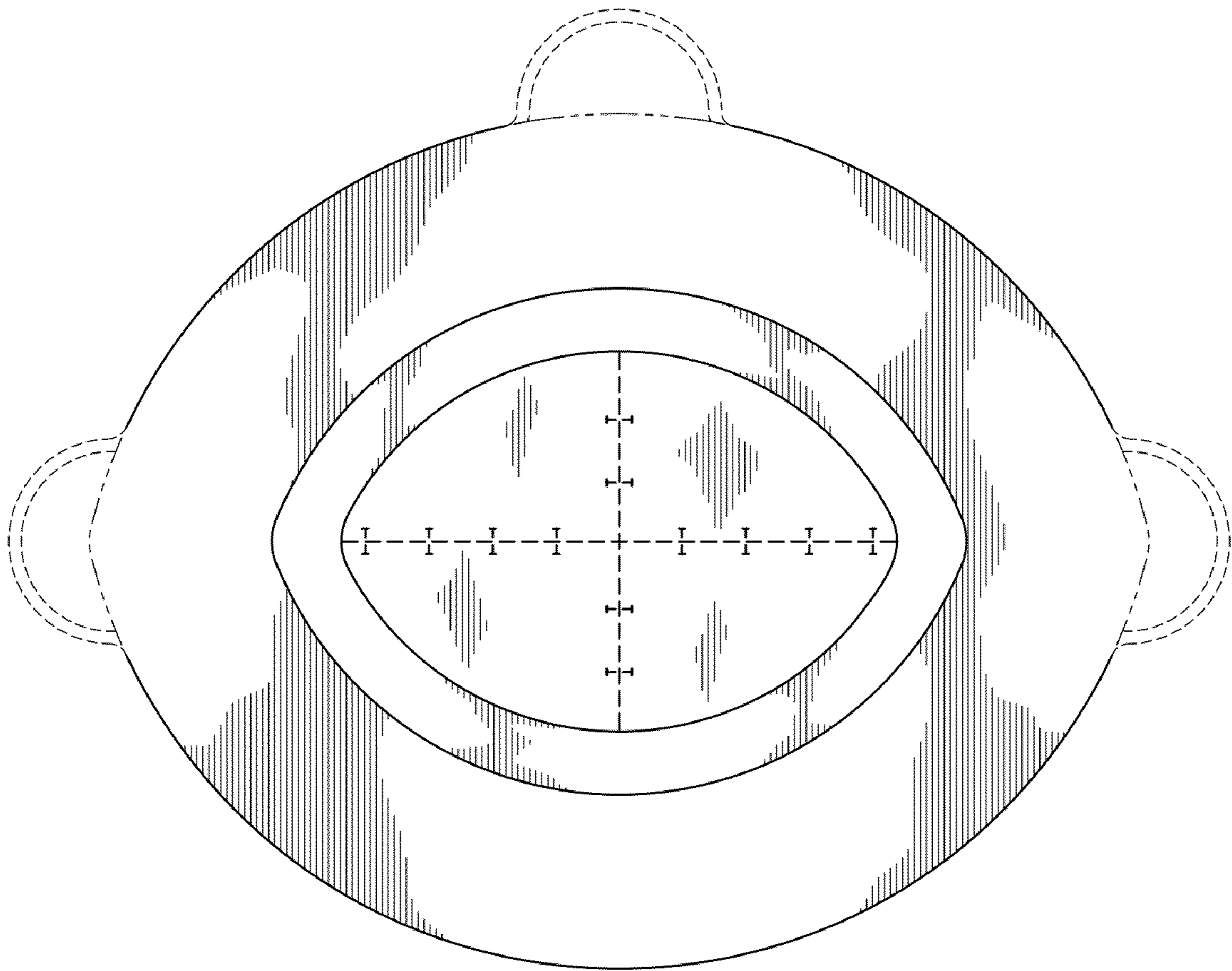

FIG. 10

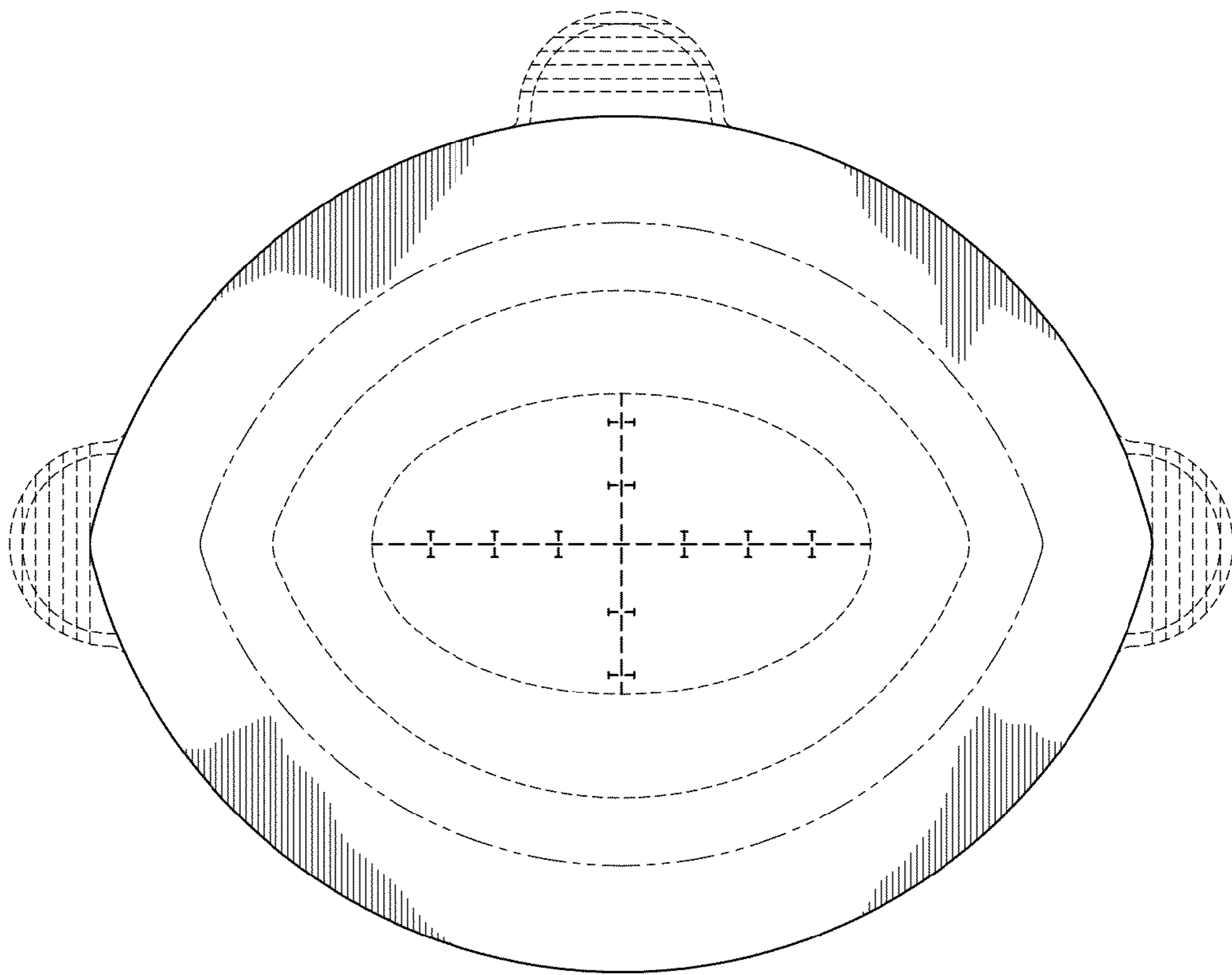

FIG. 11

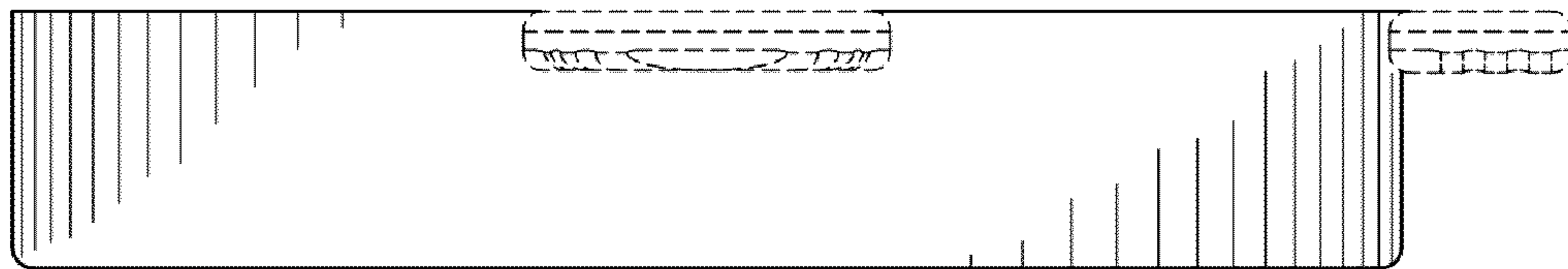

FIG. 12

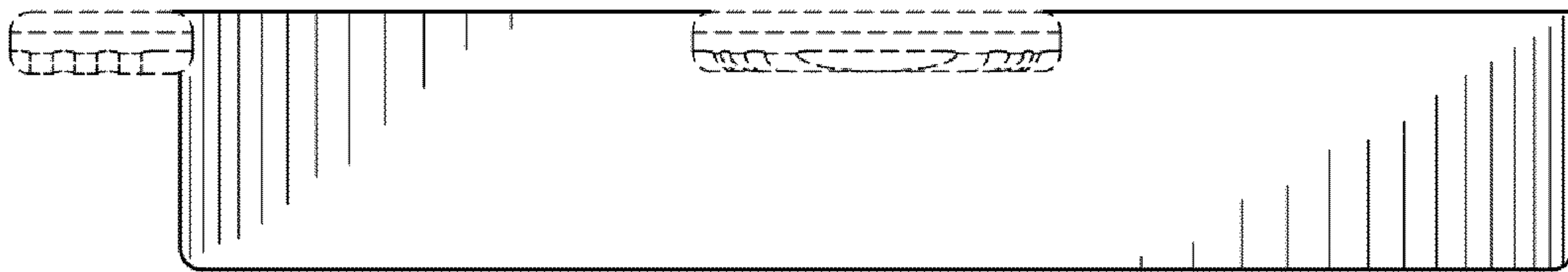

FIG. 13

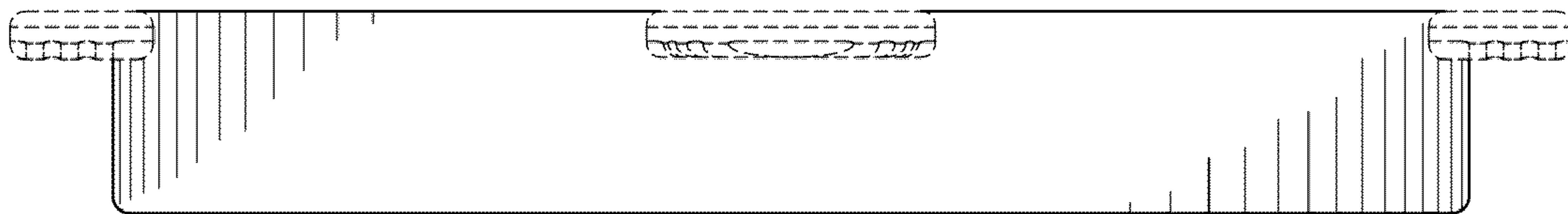

FIG. 14

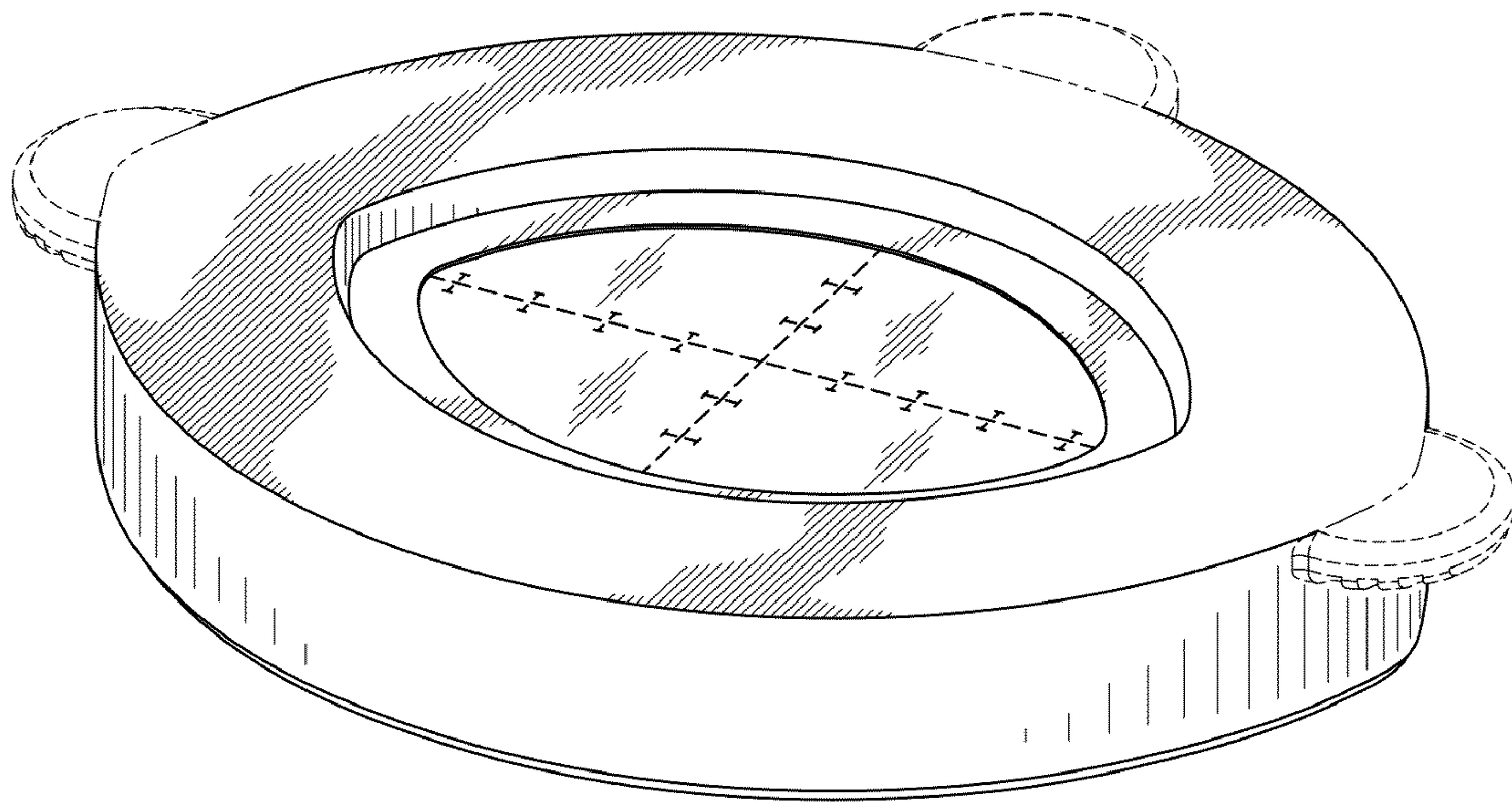

FIG. 15

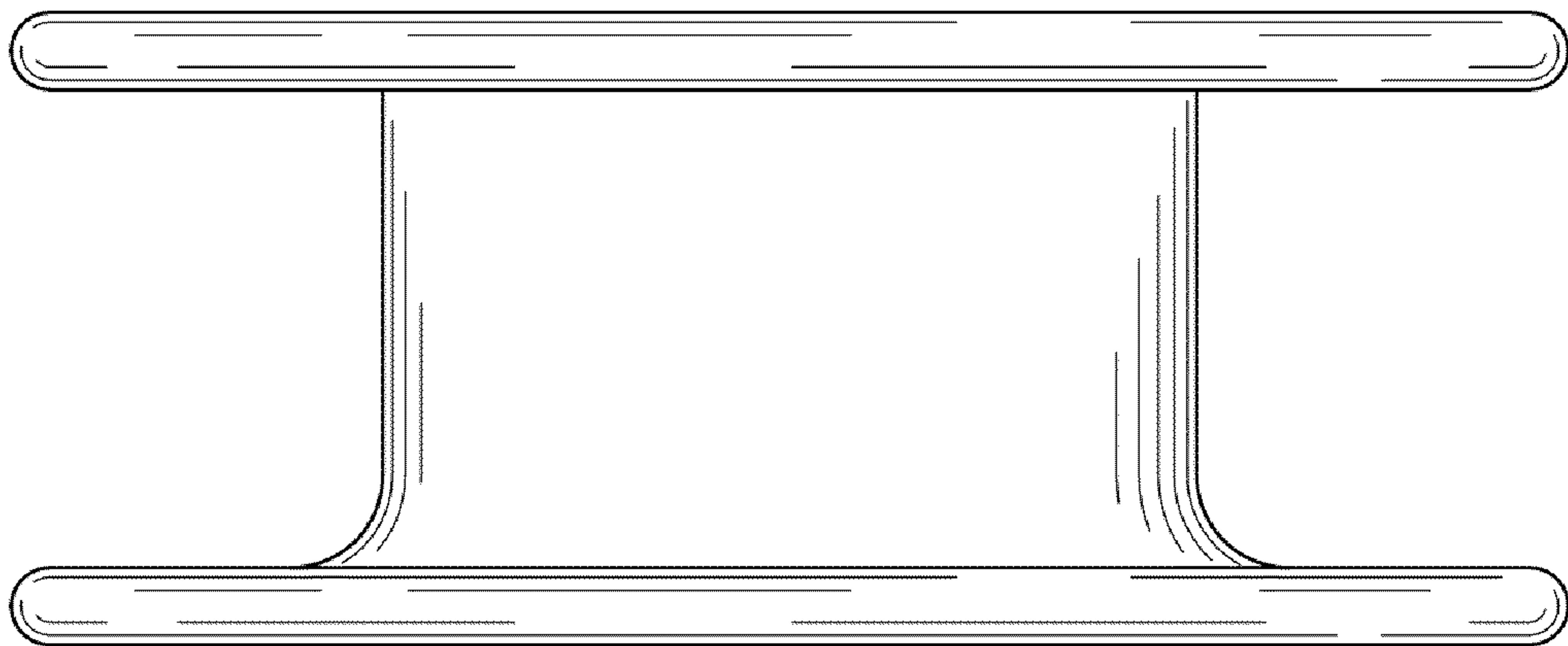

FIG. 16

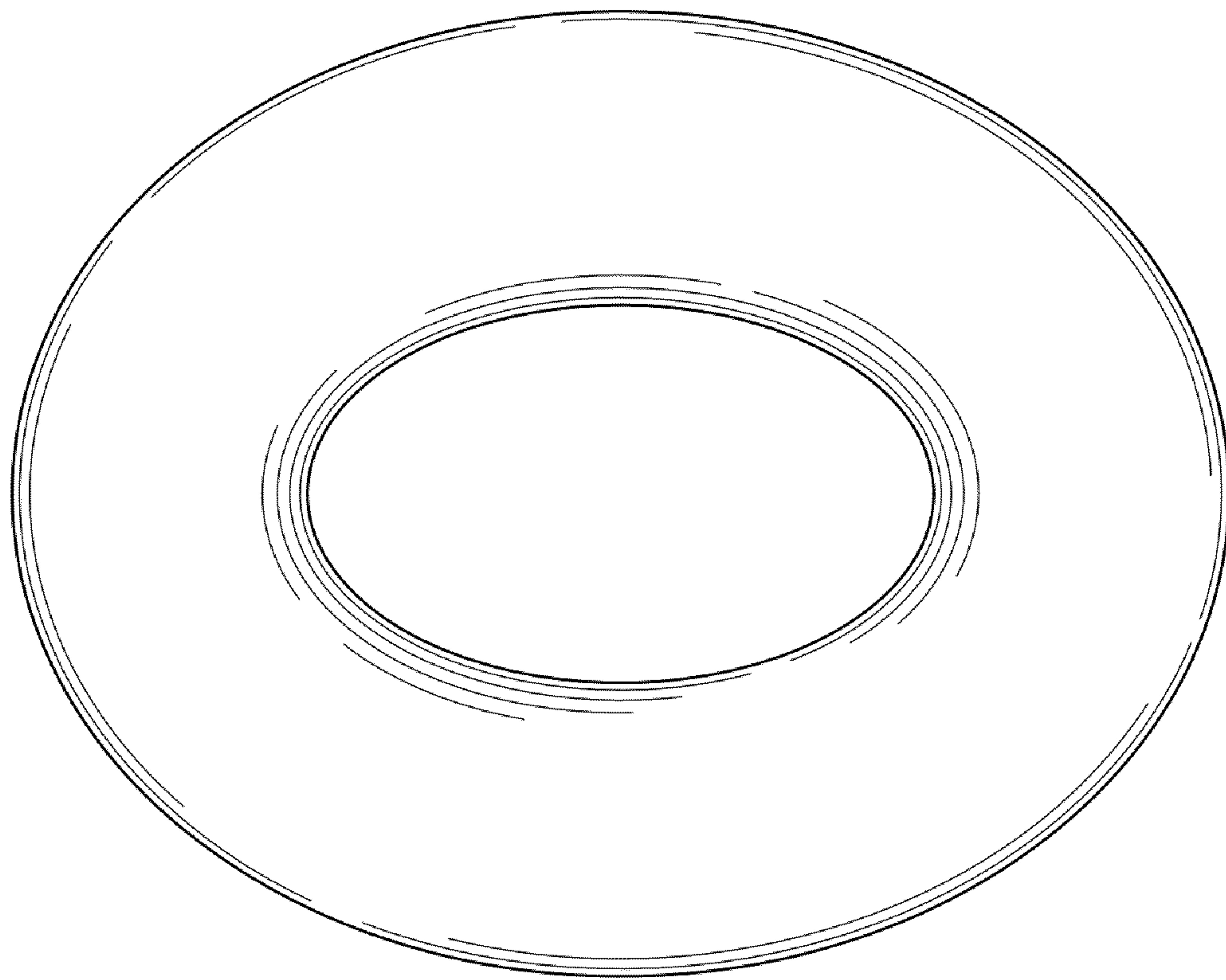

FIG. 17

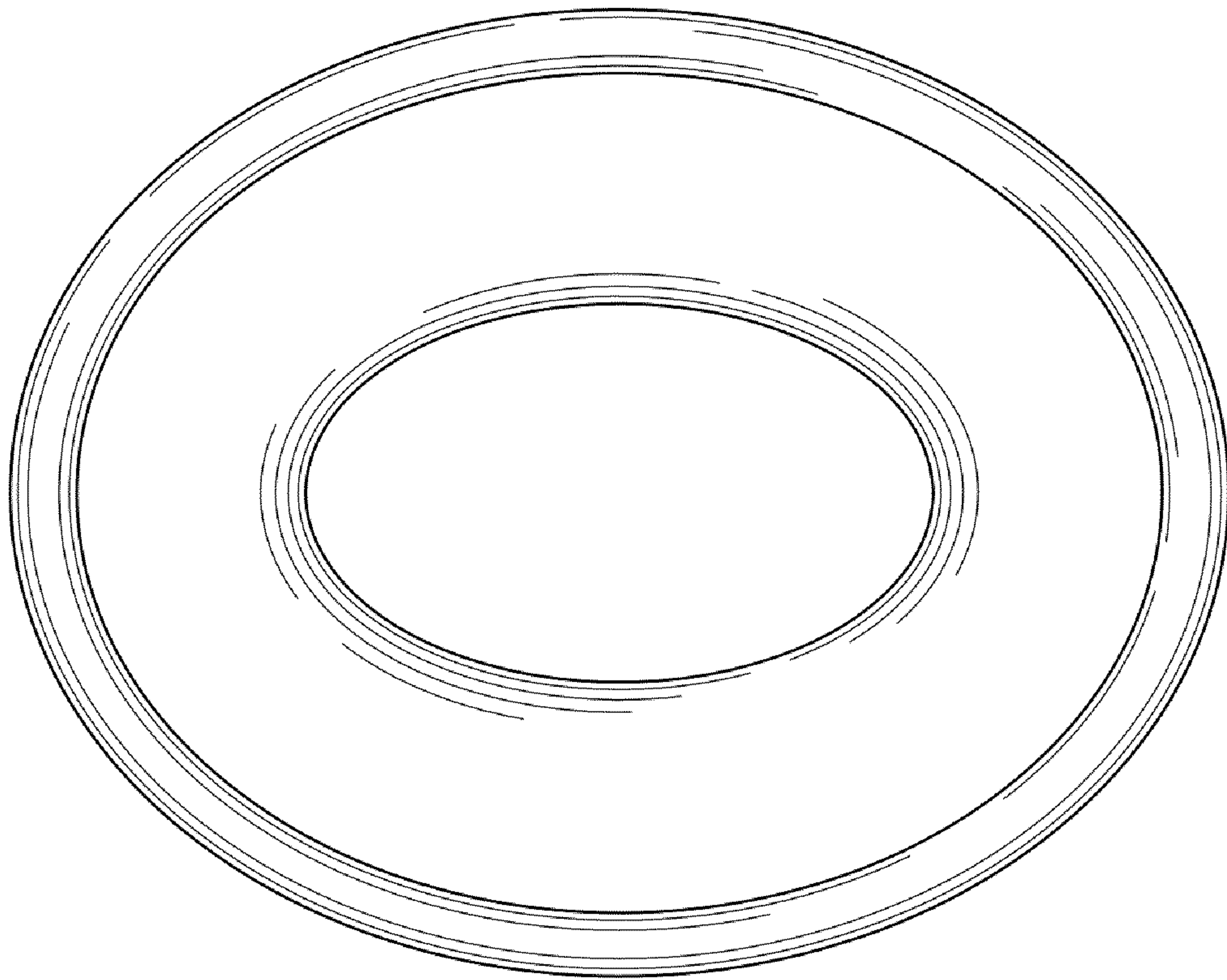

FIG. 18

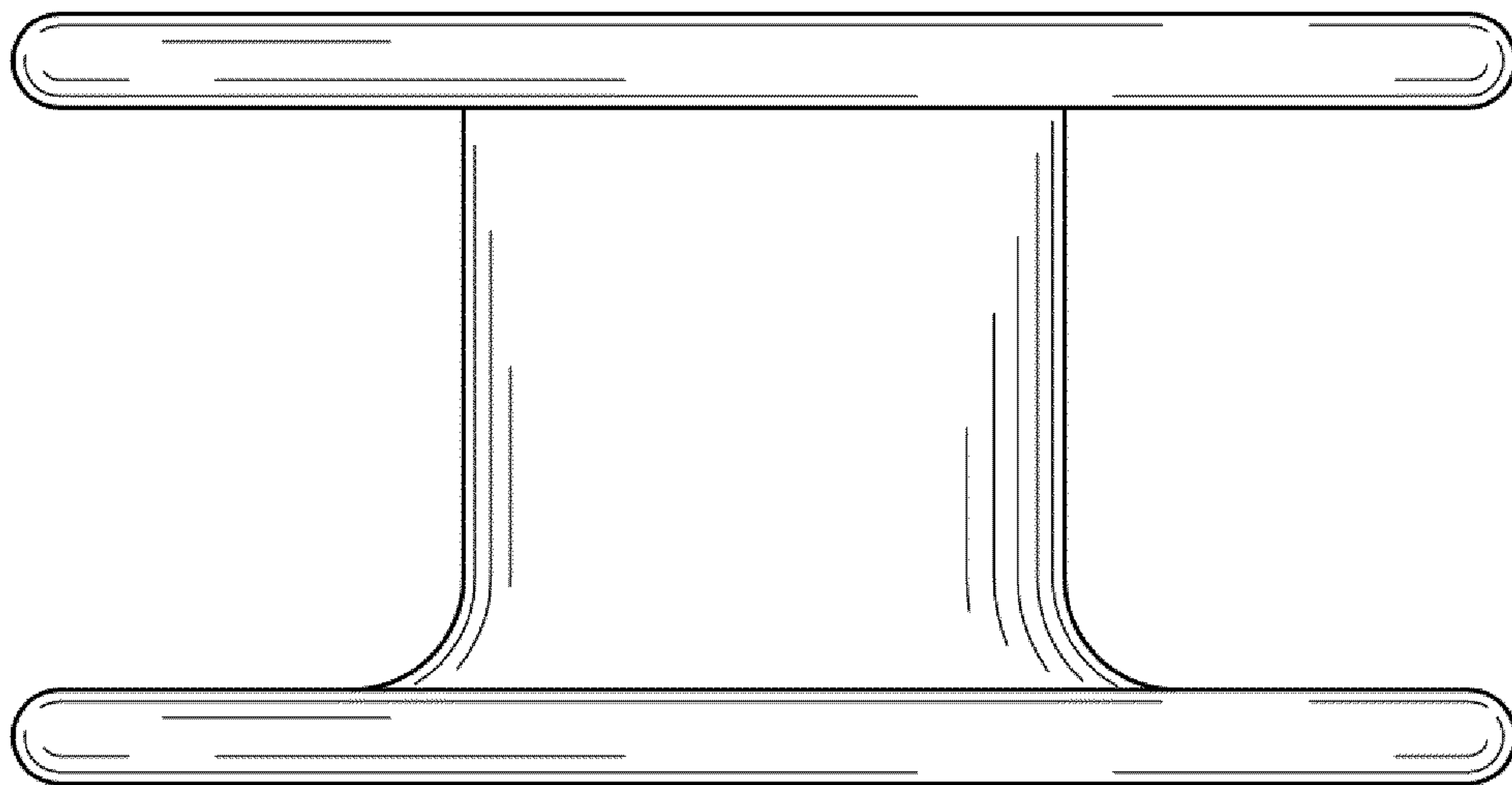

FIG. 19

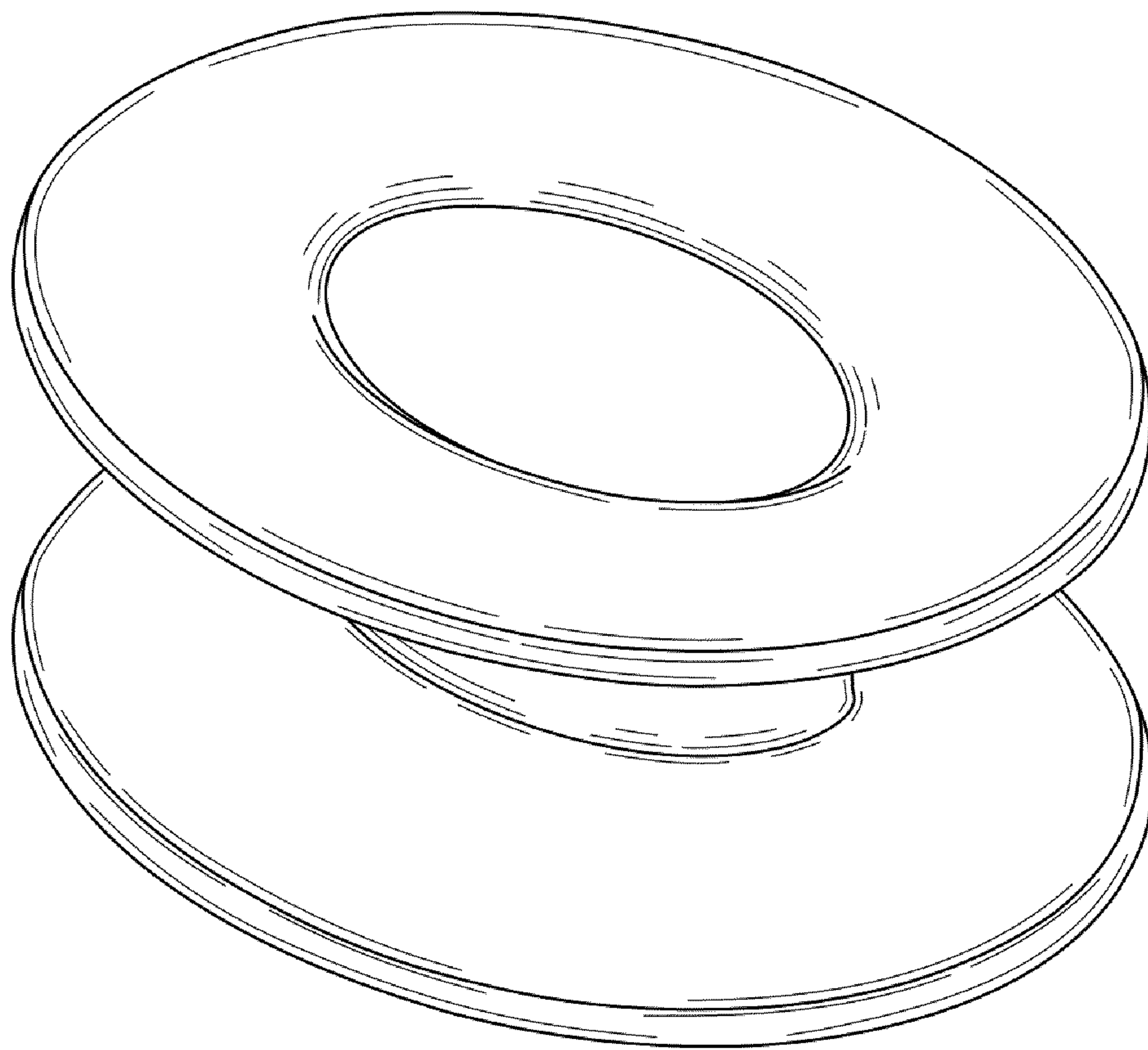

FIG. 20

