



US00D678508S

(12) **United States Design Patent**  
**Choi et al.**

(10) **Patent No.:** **US D678,508 S**  
(45) **Date of Patent:** **\*\* Mar. 19, 2013**

(54) **FILTER CARTRIDGE INTAKE PROFILE**

(75) Inventors: **Dong-II Choi**, Kyoungi-Do (KR);  
**Kyoung-Ho Lee**, Hwaseong-Si (KR);  
**Jin-Ho Lee**, Seoul (KR); **BongHyup Kang**, Seoul (KR); **Dong-Sun Noh**,  
Bucheon-Si (KR)

(73) Assignee: **3M Innovative Properties Company**,  
St. Paul, MN (US)

(\*\*) Term: **14 Years**

(21) Appl. No.: **29/389,725**

(22) Filed: **Apr. 15, 2011**

(51) **LOC (9) Cl.** ..... **29-02**

(52) **U.S. Cl.** ..... **D24/110.1**

(58) **Field of Classification Search** ..... D24/110-110.2;  
128/206.12-206.27, 207.11

See application file for complete search history.

(56) **References Cited**

**U.S. PATENT DOCUMENTS**

D518,571 S \* 4/2006 Martin ..... D24/110.1  
2005/0211251 A1 \* 9/2005 Henderson et al. .... 128/206.27  
2011/0094515 A1 \* 4/2011 Duffy ..... 128/206.19  
2012/0125342 A1 \* 5/2012 Gebrewold et al. .... 128/206.12  
2012/0260920 A1 \* 10/2012 Choi et al. .... 128/206.12

**OTHER PUBLICATIONS**

3M product literature for 3M™ 3000 Half Mask Series Respirator dated 2009.

3M product literature for 3M™ 3000 Series Single-Cartridge Half-Facepiece Respirator dated 2009.

3M product literature for 3M Respiratory Protection 7700 Series Single-Filter Half-Facepiece Respirator dated 2008.

Koken web literature for Particulate Respirators, <http://www.koken-ltd.co.jp/english/particulatesrespirators.htm>, obtained from internet on Sep. 22, 2011.

North web literature for 7190N99 Welding Half Mask, [http://www.northsafety.com/TriggerWorkflow.aspx?WorkflowModuleGUID=a3c3bf34-f500-45aa-a73f-13a246669a21&Alias=NSUS&SB\\_ContentItemGuid=b55fb755-d4a7-40dc-8e76-f21a2d582782&KeepSession=True&Tags:PC](http://www.northsafety.com/TriggerWorkflow.aspx?WorkflowModuleGUID=a3c3bf34-f500-45aa-a73f-13a246669a21&Alias=NSUS&SB_ContentItemGuid=b55fb755-d4a7-40dc-8e76-f21a2d582782&KeepSession=True&Tags:PC)

Tags:PC\_ItemGuid=0b20f978-ad7c-413f-8b8c-elee2b710a19, obtained from internet on Sep. 22, 2011.

North web literature for CFR-1 Respirator, [http://www.northsafety.com/TriggerWorkflow.aspx?WorkflowModuleGUID=a3c3bf34-f500-45aa-a73f-13a246669a21&Alias=NSUS&SB\\_ContentItemGuid=b55fb755-d4a7-40dc-8e76-f21a2d582782&KeepSession=True&Tags:PC](http://www.northsafety.com/TriggerWorkflow.aspx?WorkflowModuleGUID=a3c3bf34-f500-45aa-a73f-13a246669a21&Alias=NSUS&SB_ContentItemGuid=b55fb755-d4a7-40dc-8e76-f21a2d582782&KeepSession=True&Tags:PC)

Tags:PC\_ItemGuid=fc108711-0e93-4ab2-b78a-5cdd5bcb1e1b, obtained from internet on Sep. 22, 2011.

Shigematsu web literature for DR77R Respirator, <http://www.stsjapan.com/products/bojin/detail.php?id=DR77R>. obtained from internet on Sep. 26, 2011.

\* cited by examiner

*Primary Examiner* — Richard E Chilcot

(74) *Attorney, Agent, or Firm* — Karl G. Hanson

(57) **CLAIM**

The ornamental design for a filter cartridge intake profile, as shown and described.

**DESCRIPTION**

FIG. 1 is a perspective view, showing the new design for a filter cartridge intake profile;

FIG. 2 is a front view thereof;

FIG. 3 is a rear view thereof;

FIG. 4 is a left side view thereof;

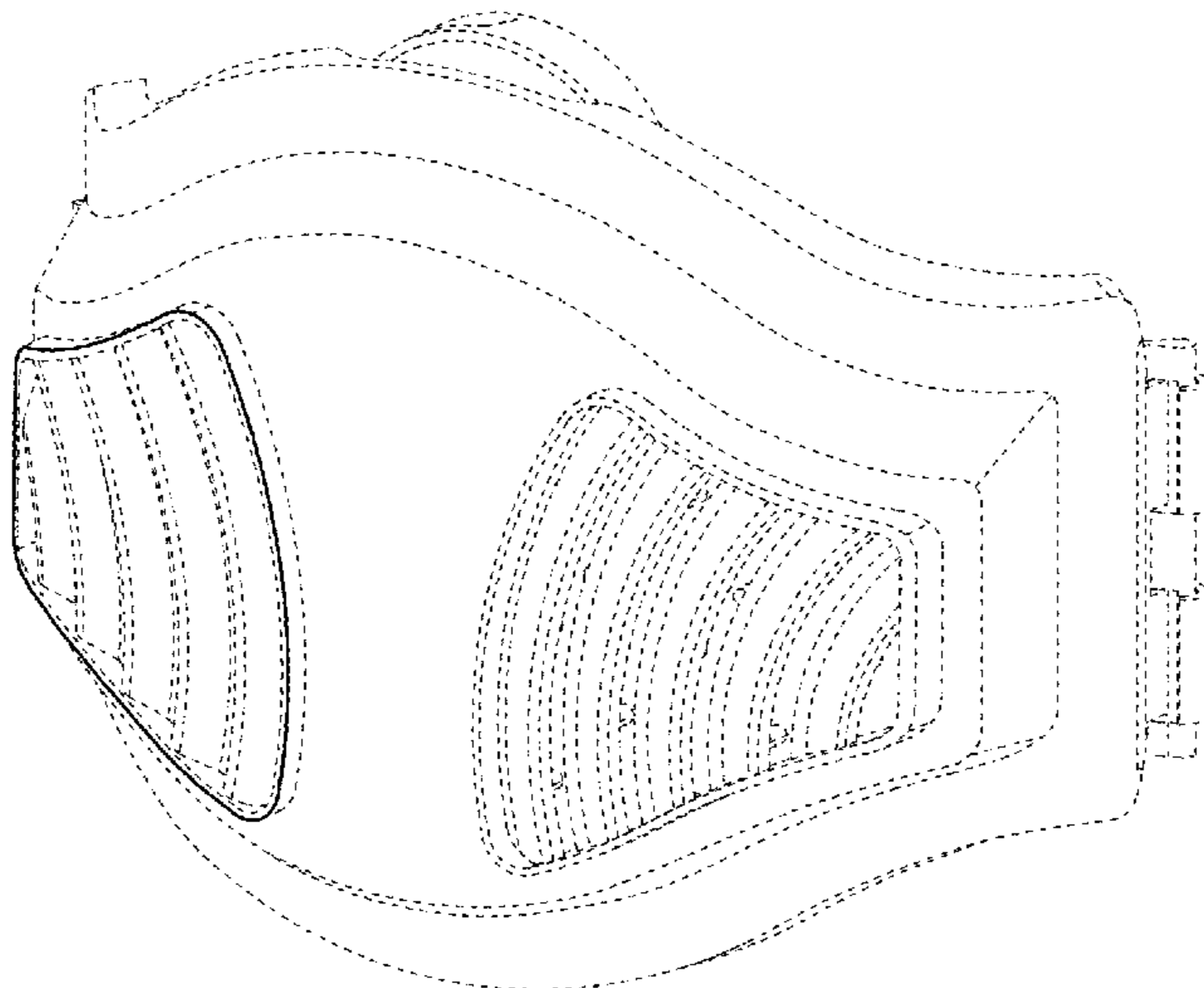
FIG. 5 is a right side view thereof;

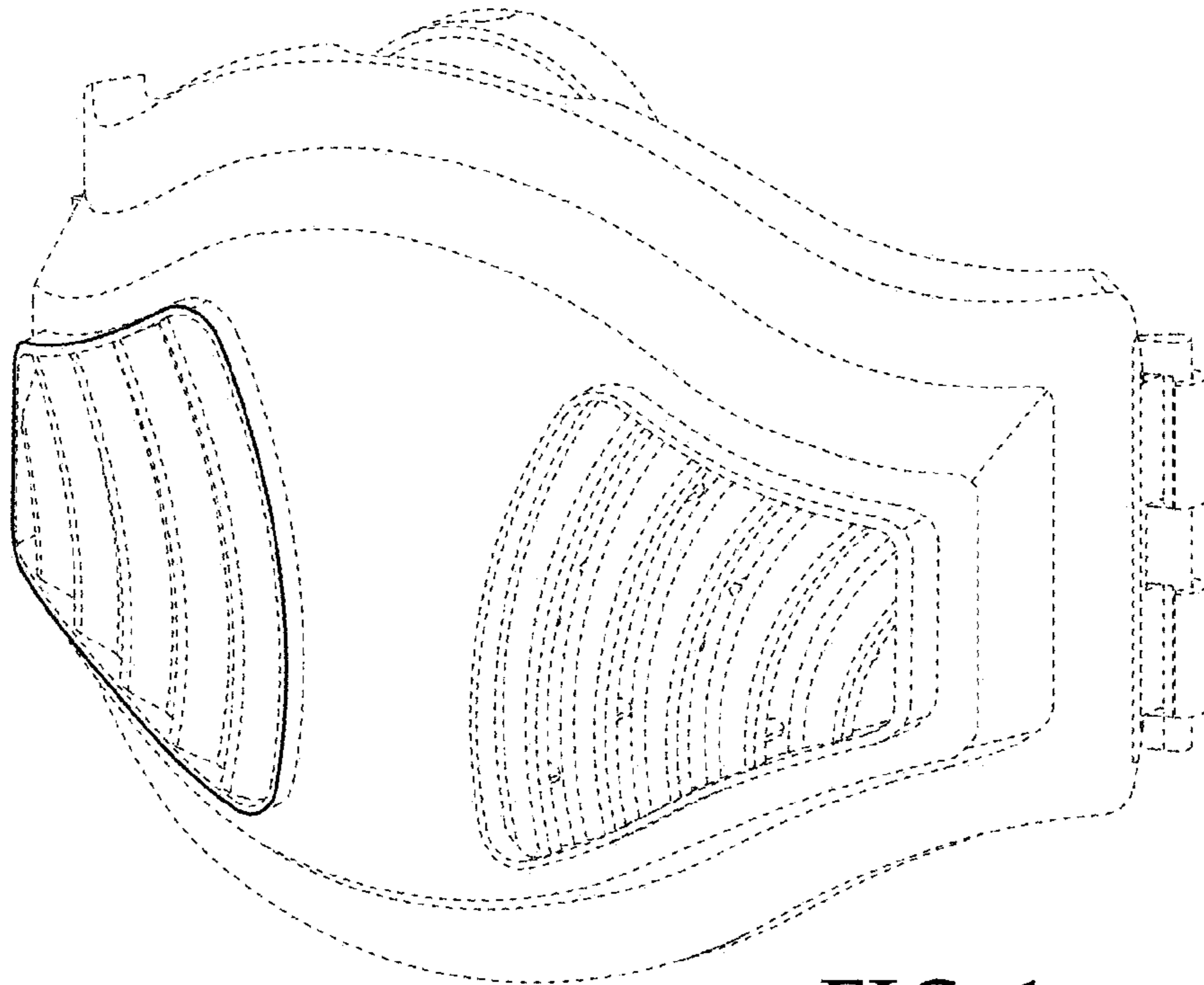
FIG. 6 is a top view thereof; and,

FIG. 7 is a bottom view thereof.

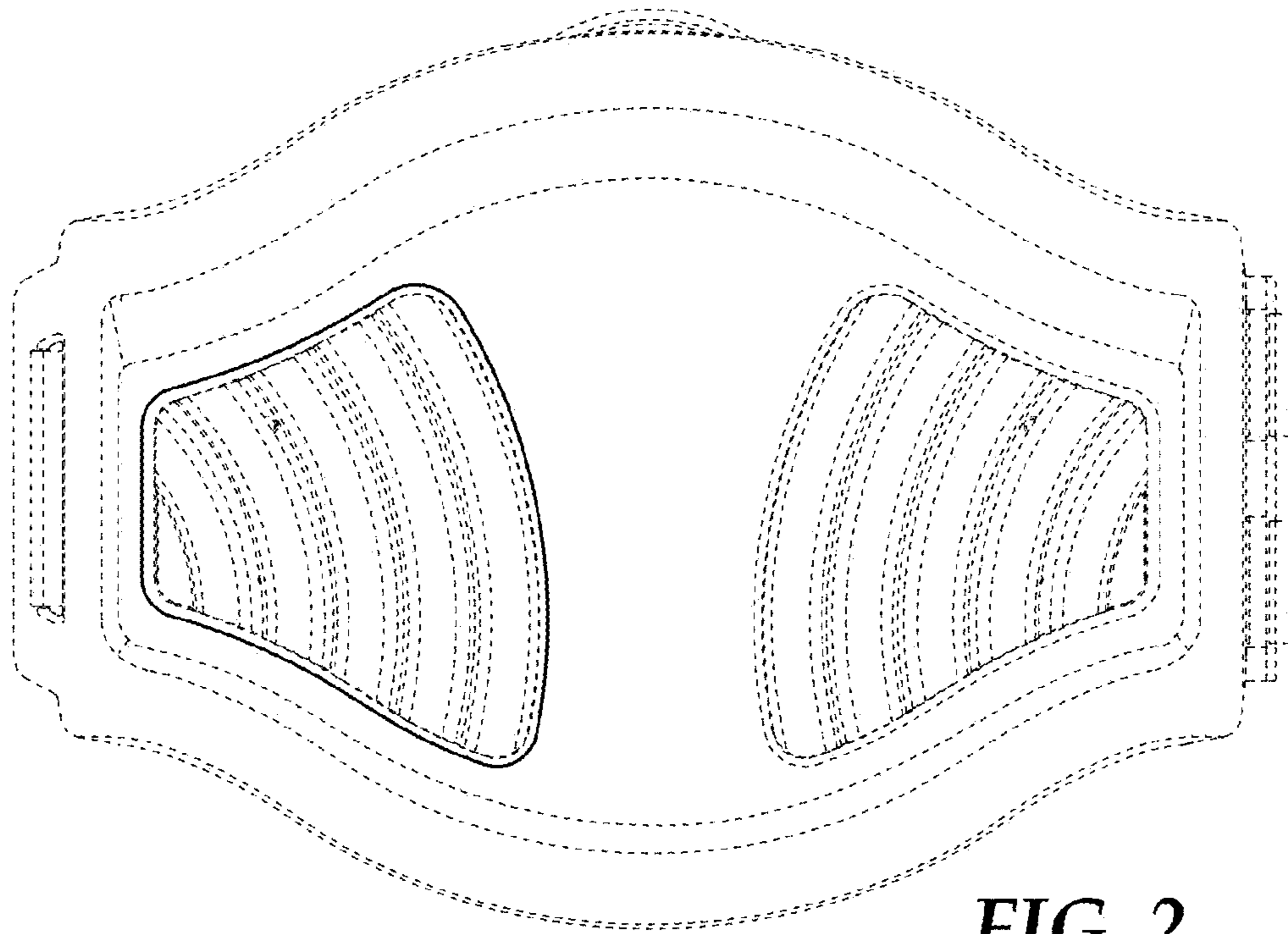
The broken line showing forms no part of the claimed design.

**1 Claim, 3 Drawing Sheets**

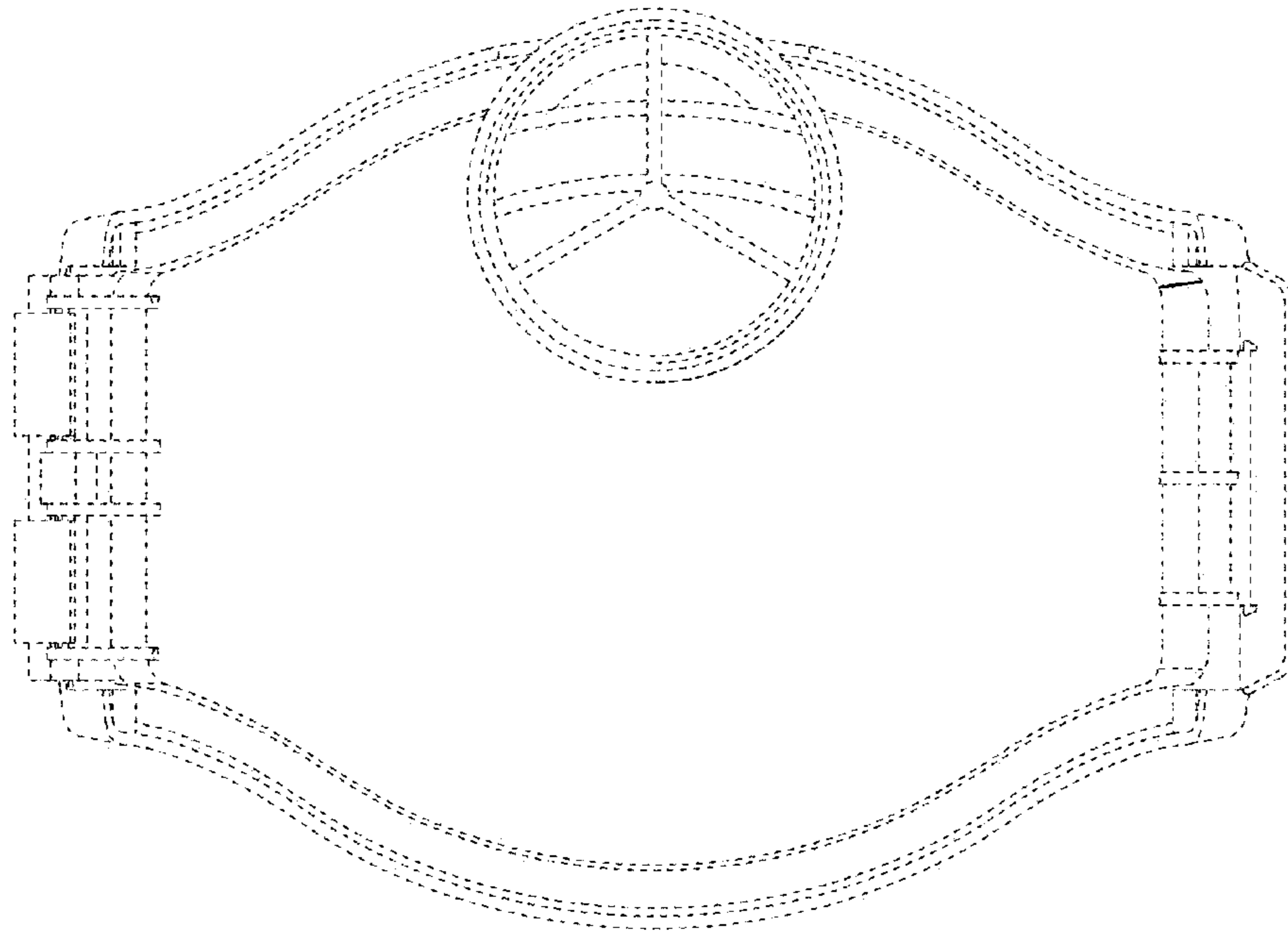




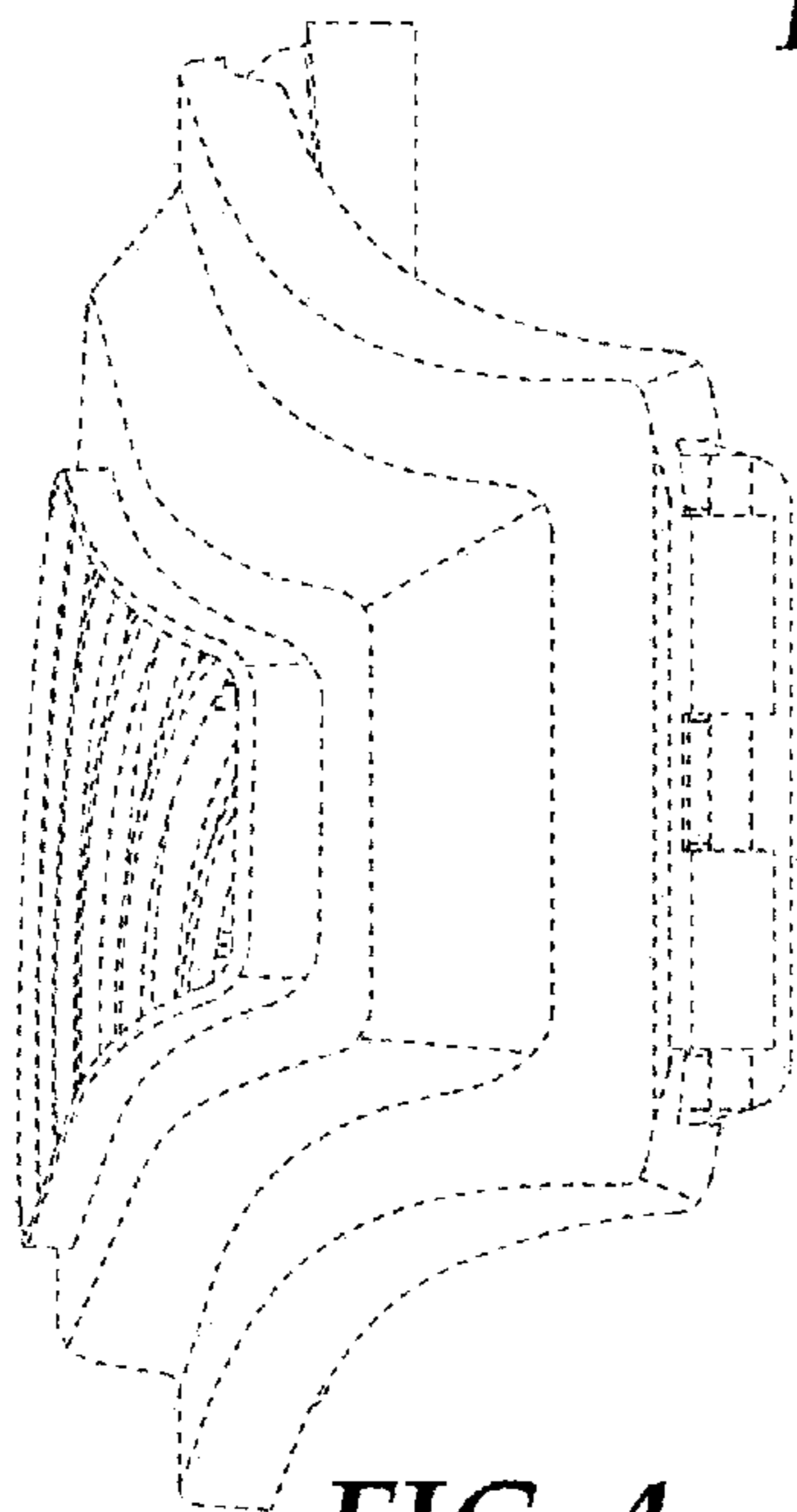
**FIG. 1**



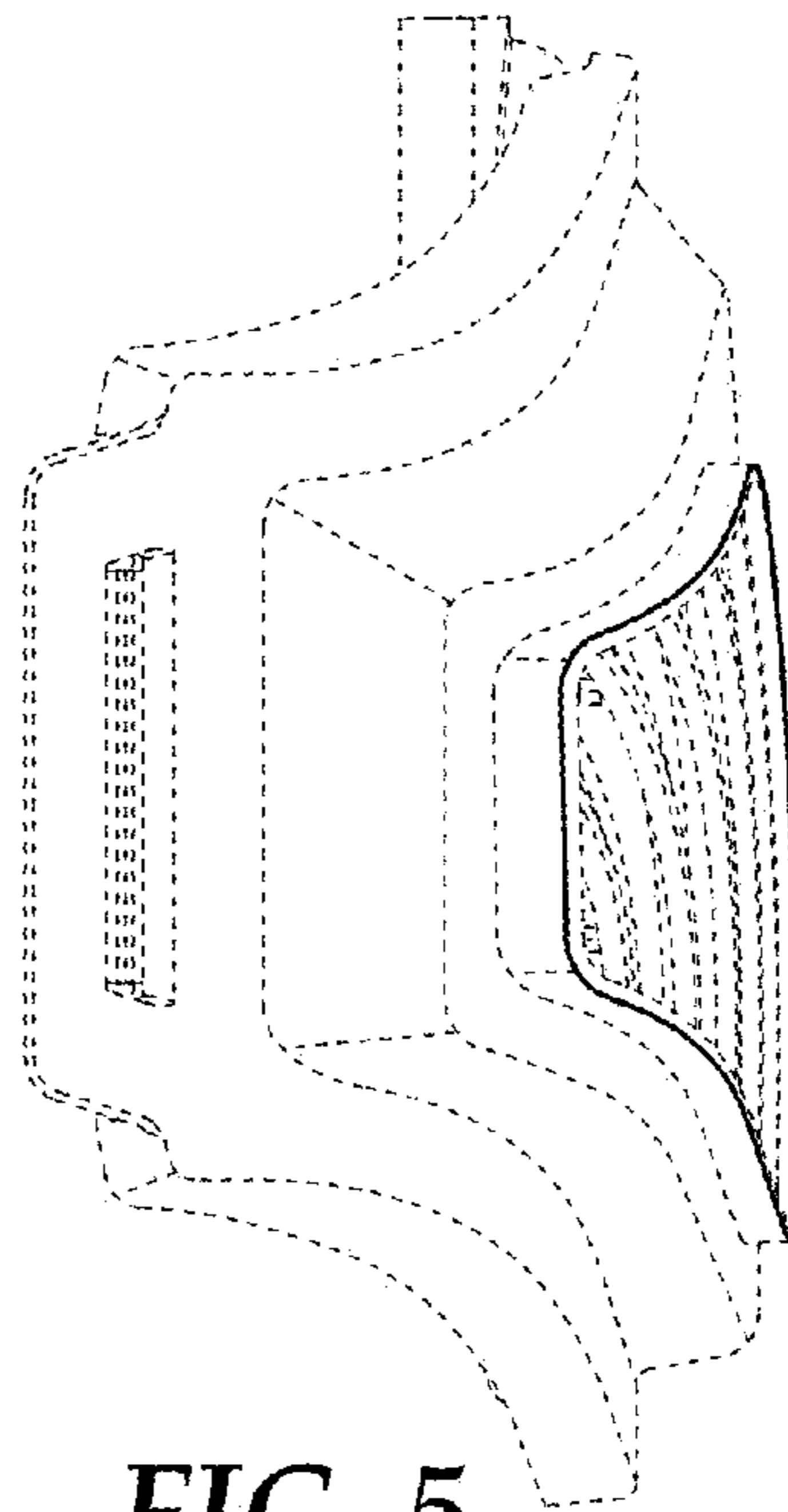
**FIG. 2**



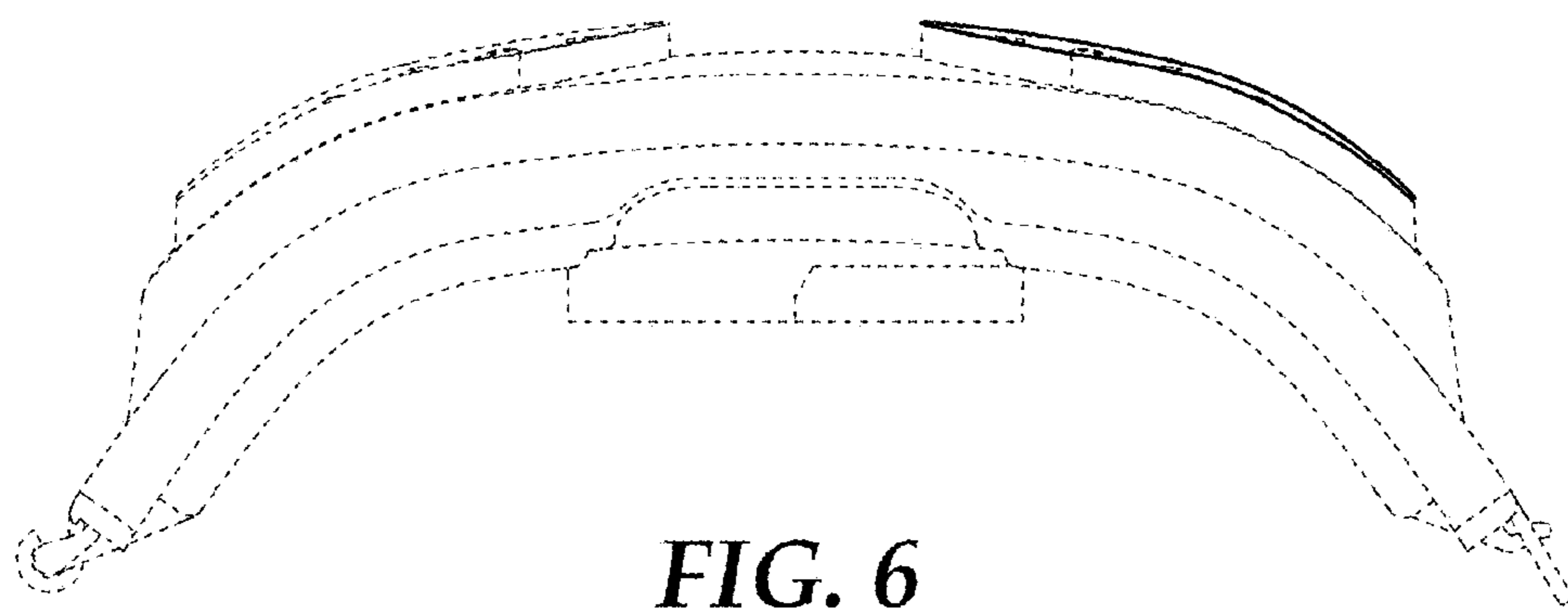
**FIG. 3**



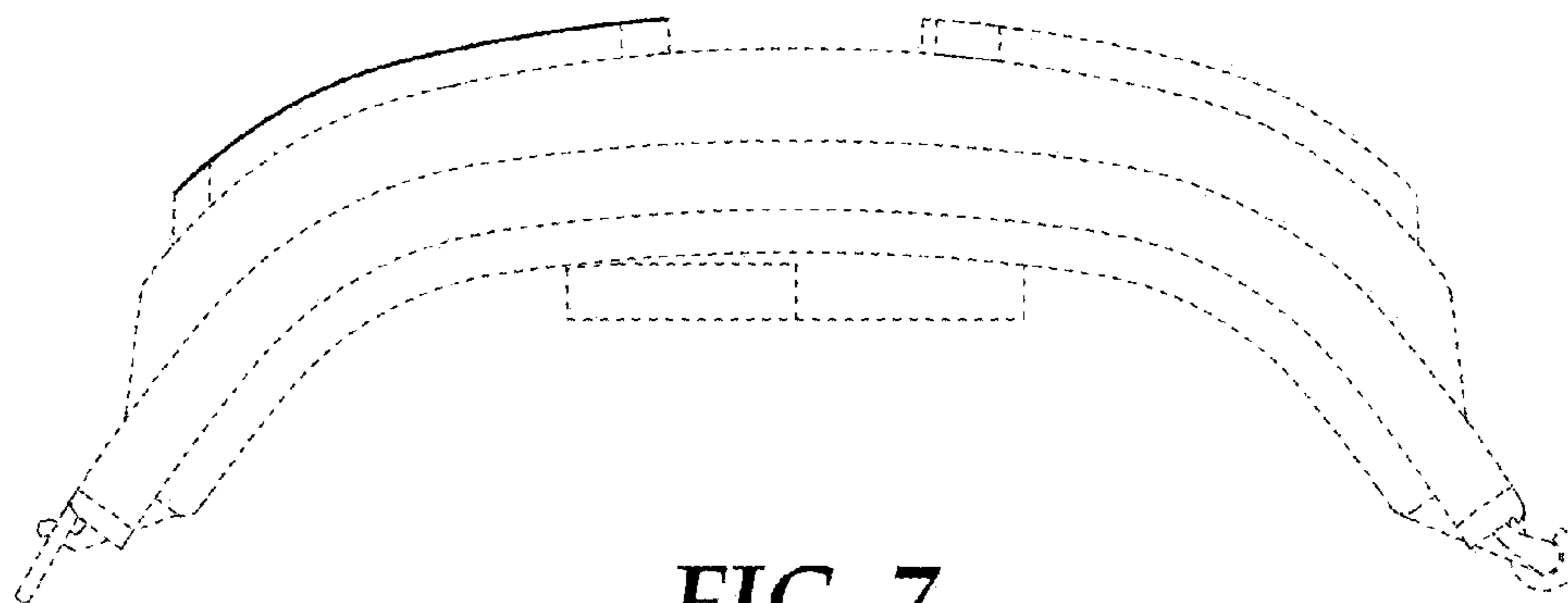
**FIG. 4**



**FIG. 5**



**FIG. 6**



**FIG. 7**