



US00D678447S

(12) **United States Design Patent**
Peterson

(10) **Patent No.:** **US D678,447 S**
(45) **Date of Patent:** **** Mar. 19, 2013**

(54) **INFLATABLE TOWABLE VEHICLE**

(76) Inventor: **Leroy L. Peterson**, Omaha, NE (US)

(**) Term: **14 Years**

(21) Appl. No.: **29/405,949**

(22) Filed: **Nov. 8, 2011**

(51) **LOC (9) Cl.** **21-06**

(52) **U.S. Cl.** **D21/803**

(58) **Field of Classification Search** D21/769-770,
D21/801, 803, 809; 114/253, 345-346; 441/35,
441/66, 40-42, 129-132; 472/128-129;
D12/5, 6, 316

See application file for complete search history.

(56) **References Cited**

U.S. PATENT DOCUMENTS

D384,636 S *	10/1997	Beck et al.	D12/316
D510,971 S *	10/2005	Hunter	D21/803
D518,133 S *	3/2006	Peterson	D21/770
D518,134 S *	3/2006	Peterson	D21/770
D526,379 S *	8/2006	Peterson	D21/803
D551,733 S *	9/2007	Peterson	D21/803
D552,202 S *	10/2007	Peterson	D21/803
D574,052 S *	7/2008	Peterson	D21/801

* cited by examiner

Primary Examiner — Zenia Bennett

(74) *Attorney, Agent, or Firm* — Suiter Swantz pc llo

(57) **CLAIM**

The ornamental design for an inflatable towable vehicle, as shown and described.

DESCRIPTION

A portion of the disclosure of this patent document, including appendices, may contain material which is subject to copyright protection. The copyright owner has no objection to the facsimile reproduction by anyone of the patent document or the patent disclosure, as it appears in the Patent and Trademark Office patent file or records, but otherwise reserves all copyright rights whatsoever.

FIG. 1 is a perspective view of the inflatable towable vehicle showing my new design;

FIG. 2 is a left side elevation view thereof;

FIG. 3 is a right side elevation view thereof;

FIG. 4 is a front elevation view thereof;

FIG. 5 is a rear elevation view thereof;

FIG. 6 is a top plan view thereof; and,

FIG. 7 is a bottom plan view thereof. The broken lines are for environmental purposes only and form no part of the claimed design.

1 Claim, 5 Drawing Sheets

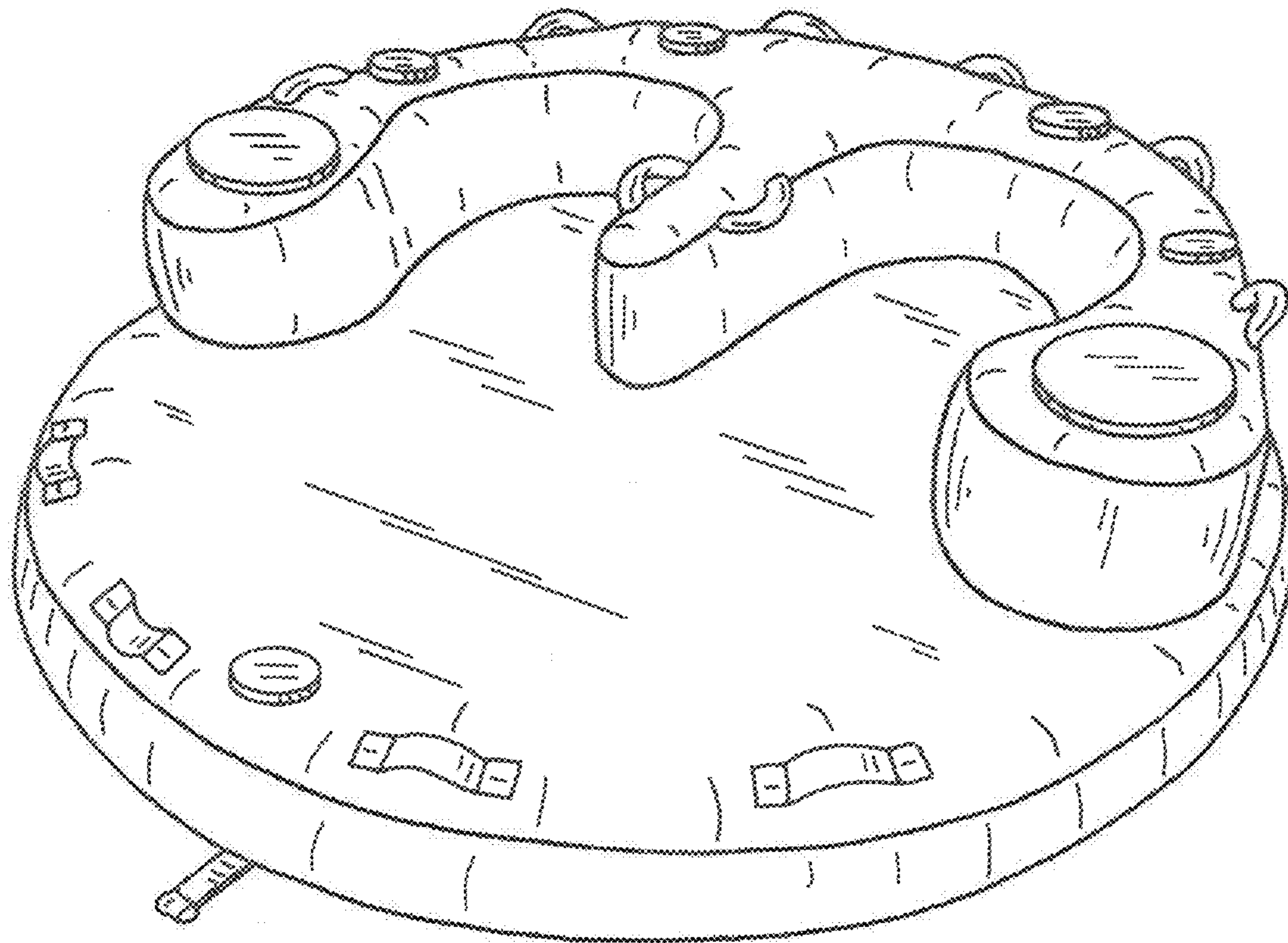

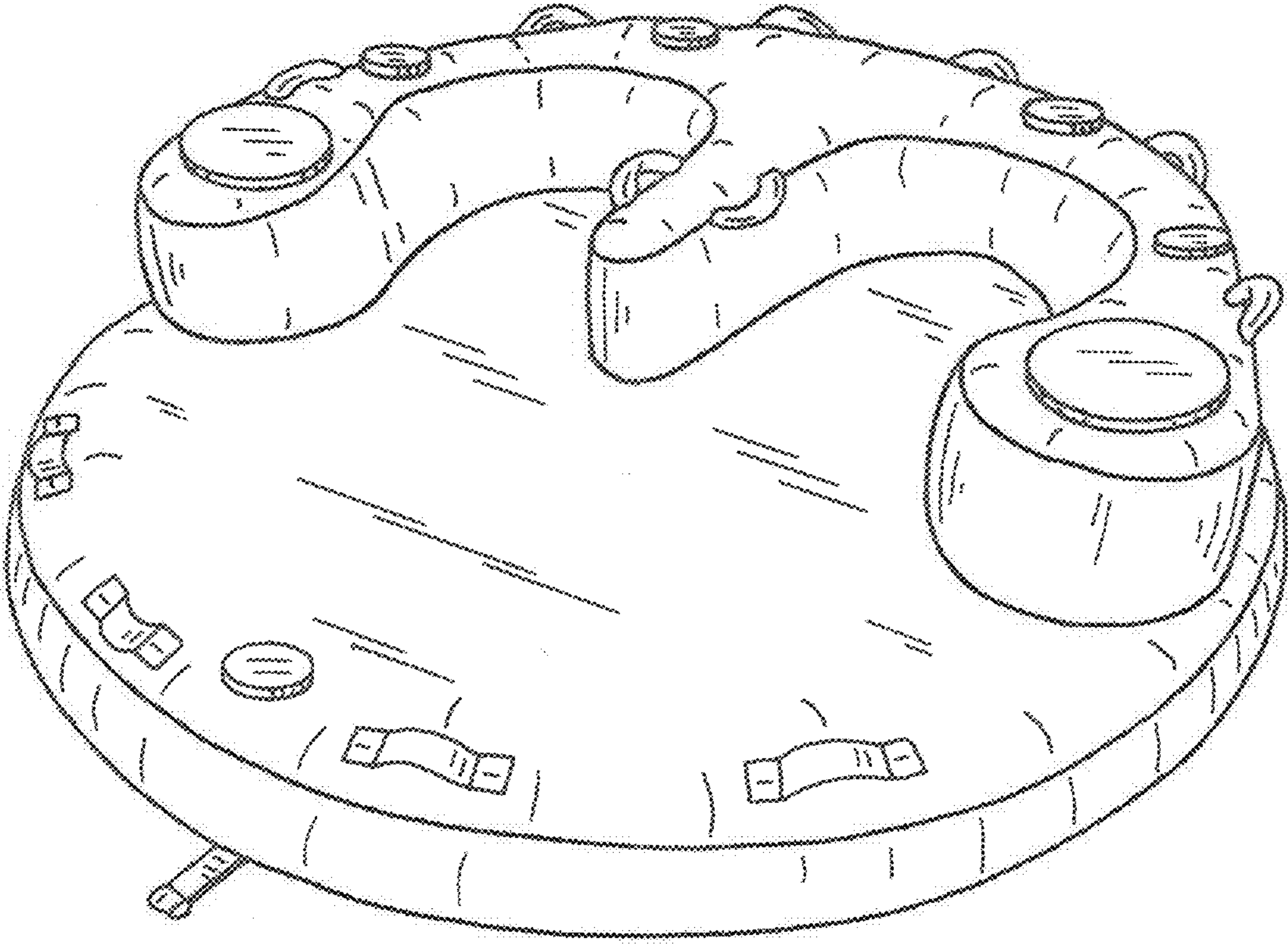

Fig. 1

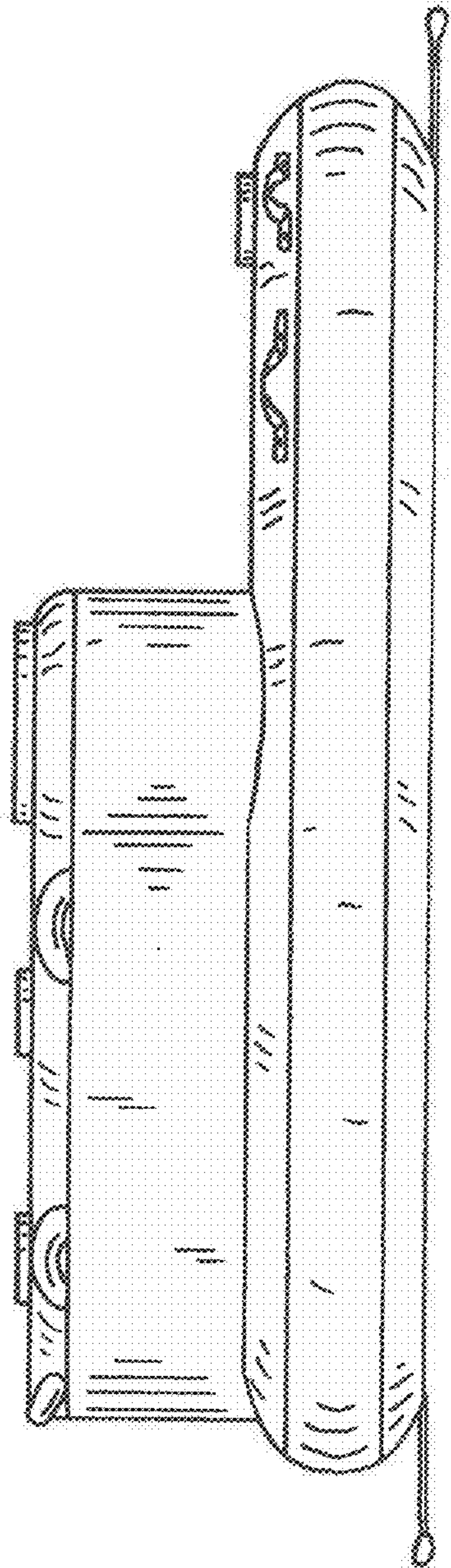

Fig. 2

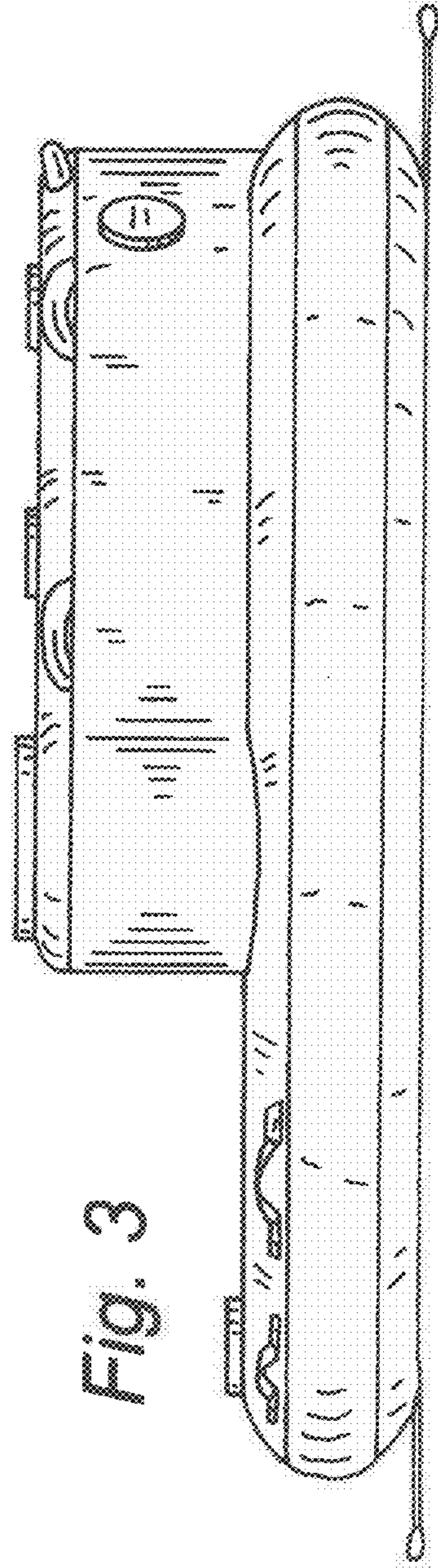

Fig. 3

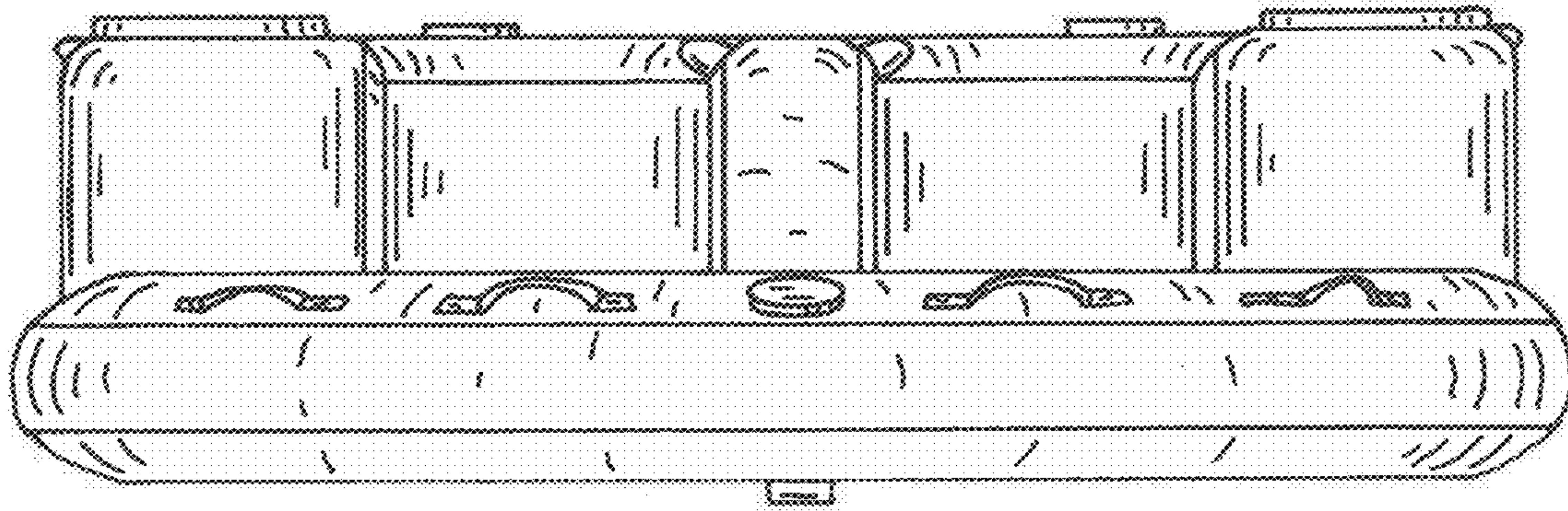

Fig. 4

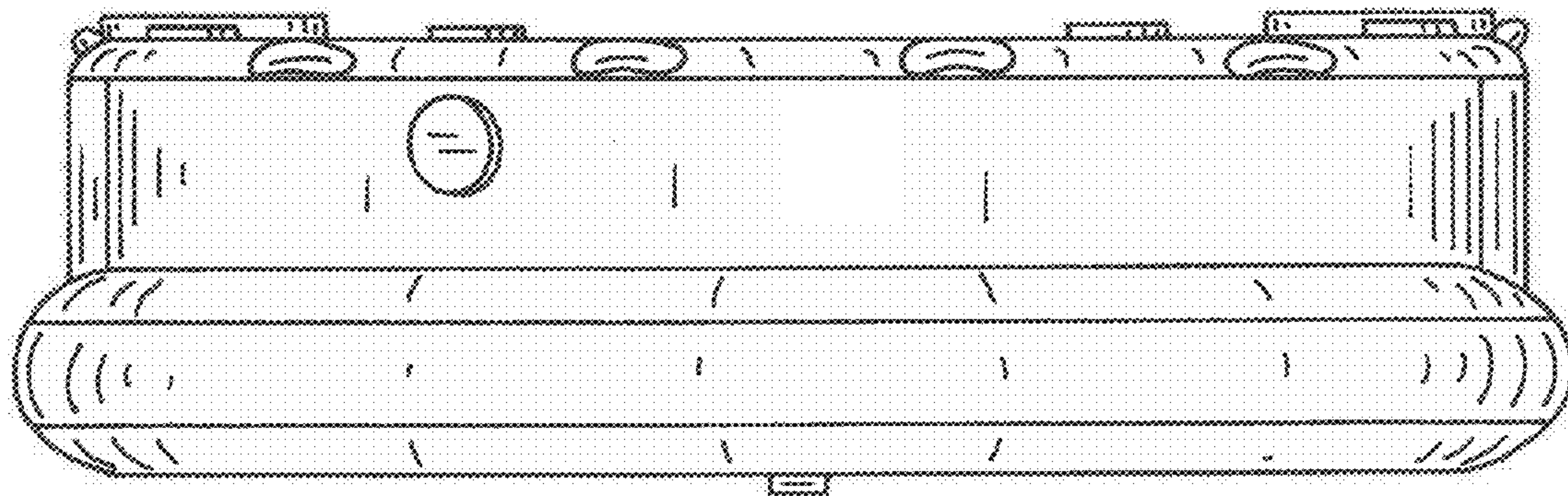

Fig. 5

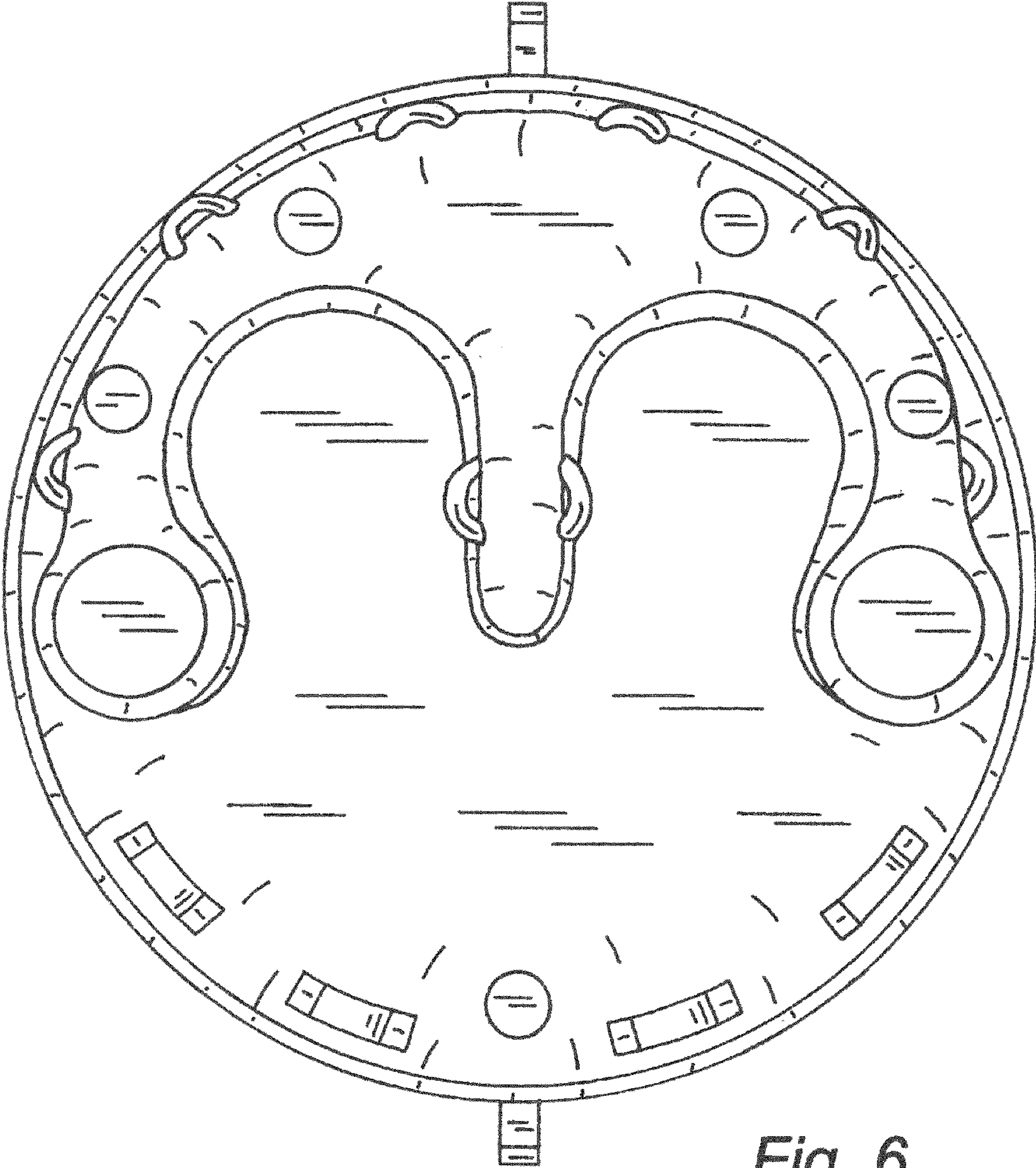

Fig. 6

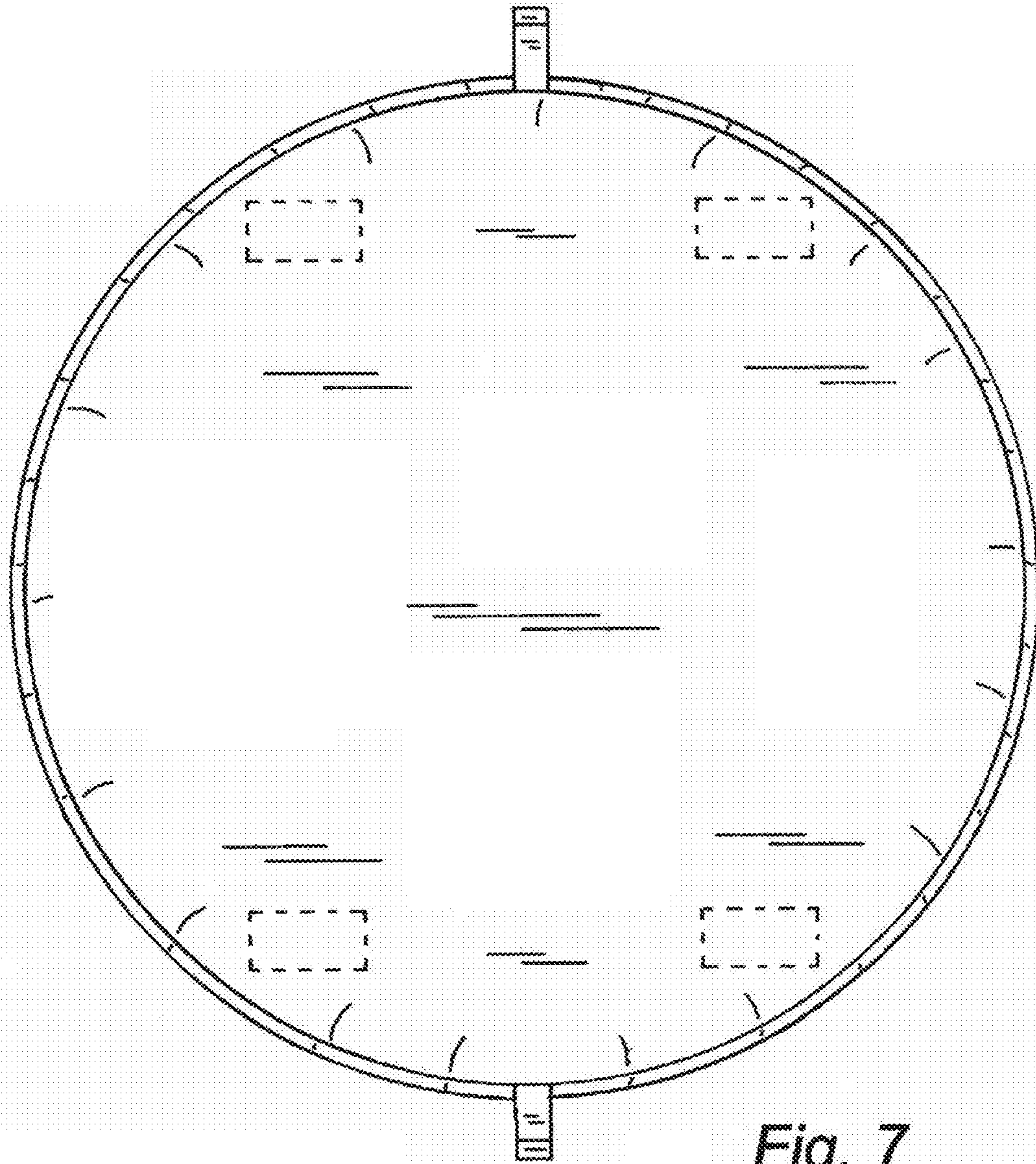

Fig. 7