



US00D678390S

(12) **United States Design Patent**
Fuchs

(10) **Patent No.:** **US D678,390 S**
(45) **Date of Patent:** **** Mar. 19, 2013**

(54) **EYEGLASSES**

(75) Inventor: **Gerhard Fuchs**, Kauns (AT)

(73) Assignee: **Silhouette International Schmied AG**,
Linz (AT)

(**) Term: **14 Years**

(21) Appl. No.: **29/432,281**

(22) Filed: **Sep. 14, 2012**

(30) **Foreign Application Priority Data**

Jul. 6, 2012 (EM) 002069260

(51) **LOC (9) Cl.** **16-06**

(52) **U.S. Cl.** **D16/315; D18/335**

(58) **Field of Classification Search** D16/101,
D16/300-342, 900; D29/109-110; D24/110.2;
351/41, 44, 51-52, 62, 158, 92, 103-123,
351/140, 153, 45-46; 2/426-432, 447-449,
2/441, 434-437, 13, 15; D21/483, 659-661;
D14/372

See application file for complete search history.

(56) **References Cited**

U.S. PATENT DOCUMENTS

5,367,344 A * 11/1994 Fuchs 351/41
6,296,355 B1 * 10/2001 Rittmann 351/111
6,729,725 B1 * 5/2004 Cheng 351/110
D533,579 S * 12/2006 Raile D16/316
D536,023 S * 1/2007 Park D16/315
D554,176 S * 10/2007 Elmore D16/316

D556,819 S 12/2007 Fuchs
D567,838 S 4/2008 Fuchs
D567,839 S 4/2008 Fuchs
D572,293 S * 7/2008 Cheng D16/315
D577,377 S * 9/2008 Fuchs D16/315
D590,005 S * 4/2009 Fuchs D16/316
D602,975 S 10/2009 Fuchs
2003/0025871 A1 * 2/2003 Masunaga 351/110
2003/0071962 A1 * 4/2003 Nishihara 351/110
2004/0223114 A1 * 11/2004 Park 351/110

OTHER PUBLICATIONS

Fuchs; U.S. Appl. No. 29/385,496, filed Feb. 15, 2011.

* cited by examiner

Primary Examiner — Raphael Barkai

(74) *Attorney, Agent, or Firm* — Alston & Bird LLP

(57) **CLAIM**

I claim the ornamental design for eyeglasses, as shown and described.

DESCRIPTION

FIG. 1 is a perspective view of eyeglasses showing my new design;

FIG. 2 is a front elevation view thereof;

FIG. 3 is a rear elevation view thereof;

FIG. 4 is a top plan view thereof;

FIG. 5 is a bottom plan view thereof;

FIG. 6 is a left side elevation view thereof; and,

FIG. 7 is a right side elevation view thereof.

The broken lines are directed to unclaimed features. The broken lines form no part of the claimed design.

1 Claim, 5 Drawing Sheets

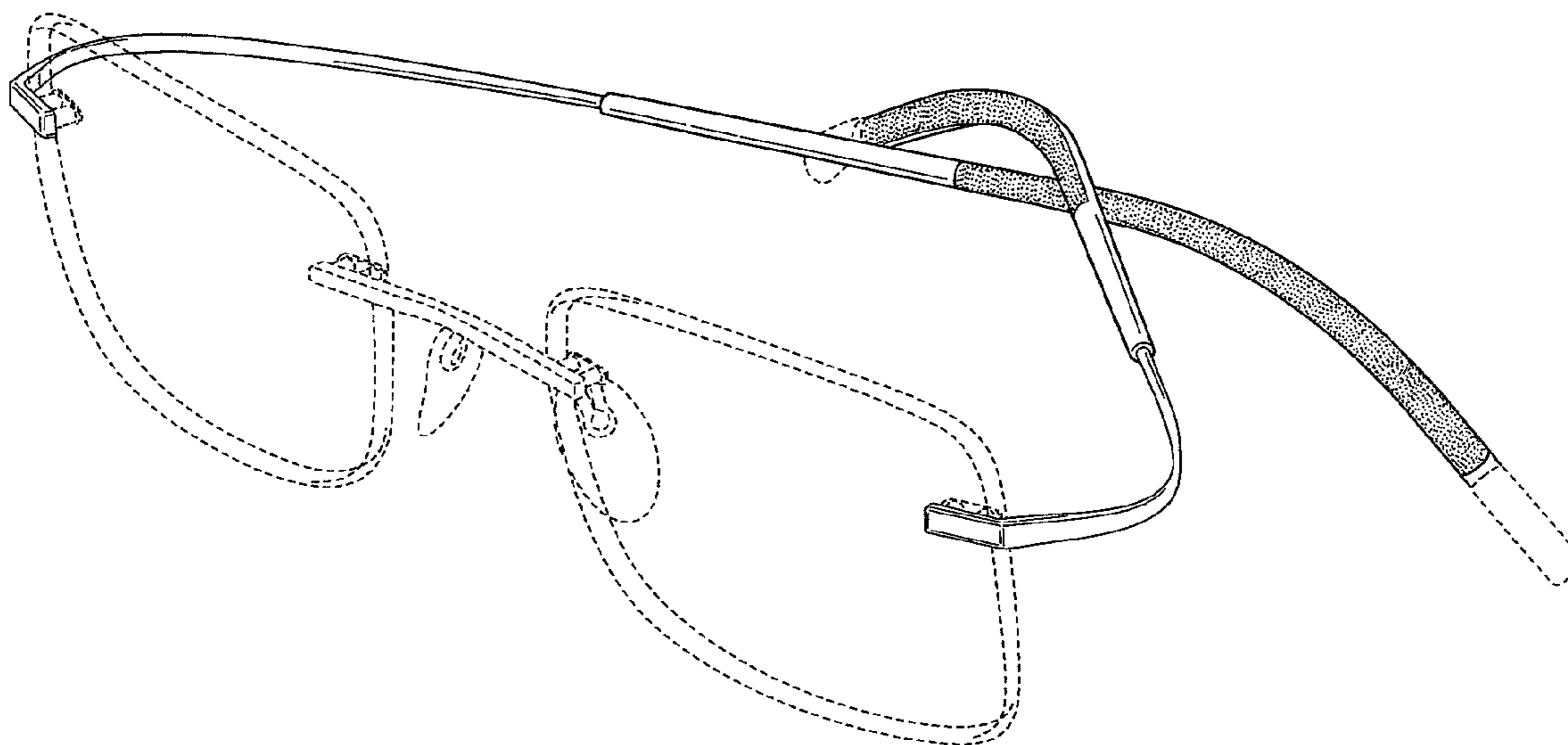

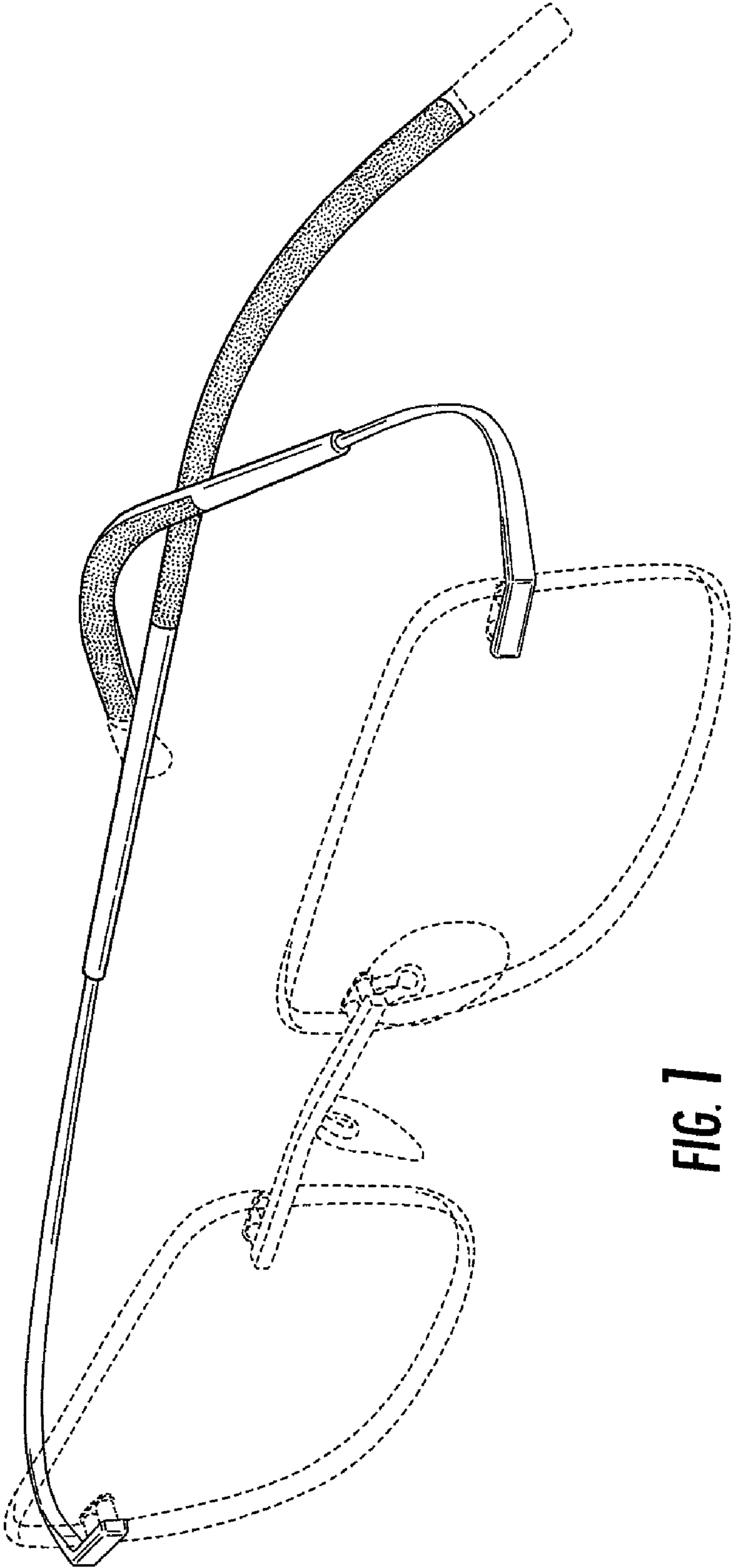

FIG. 1

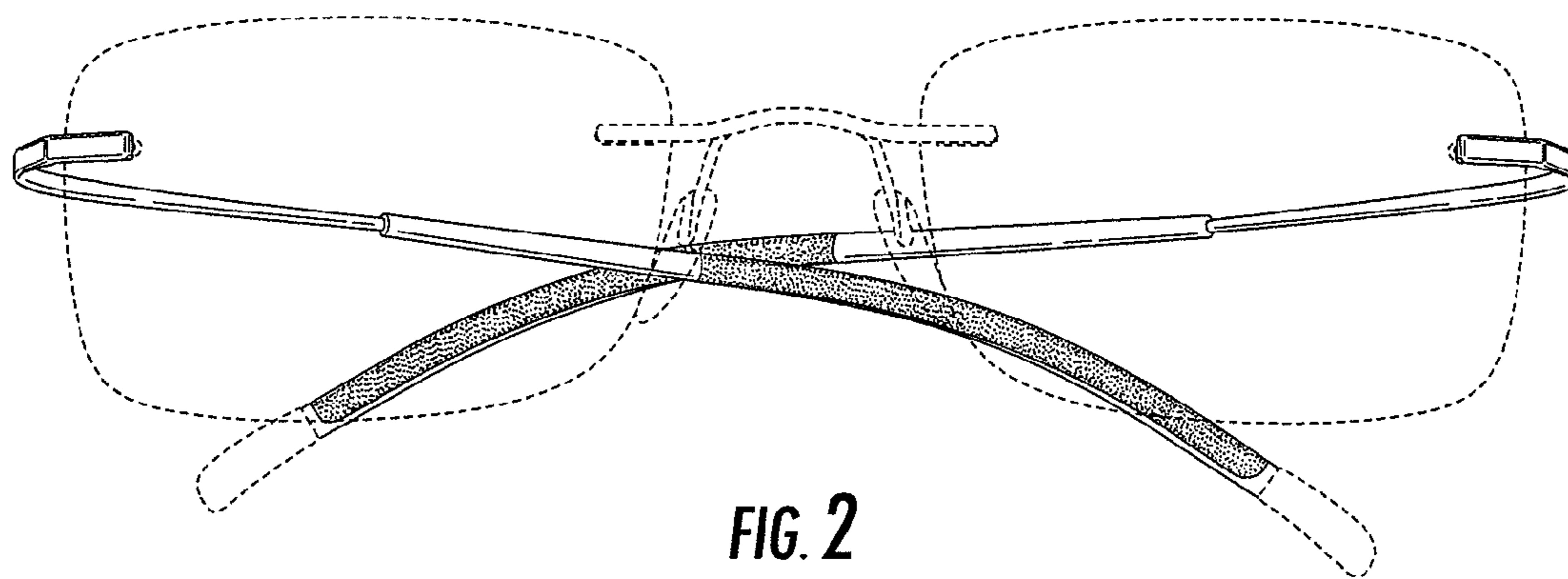

FIG. 2

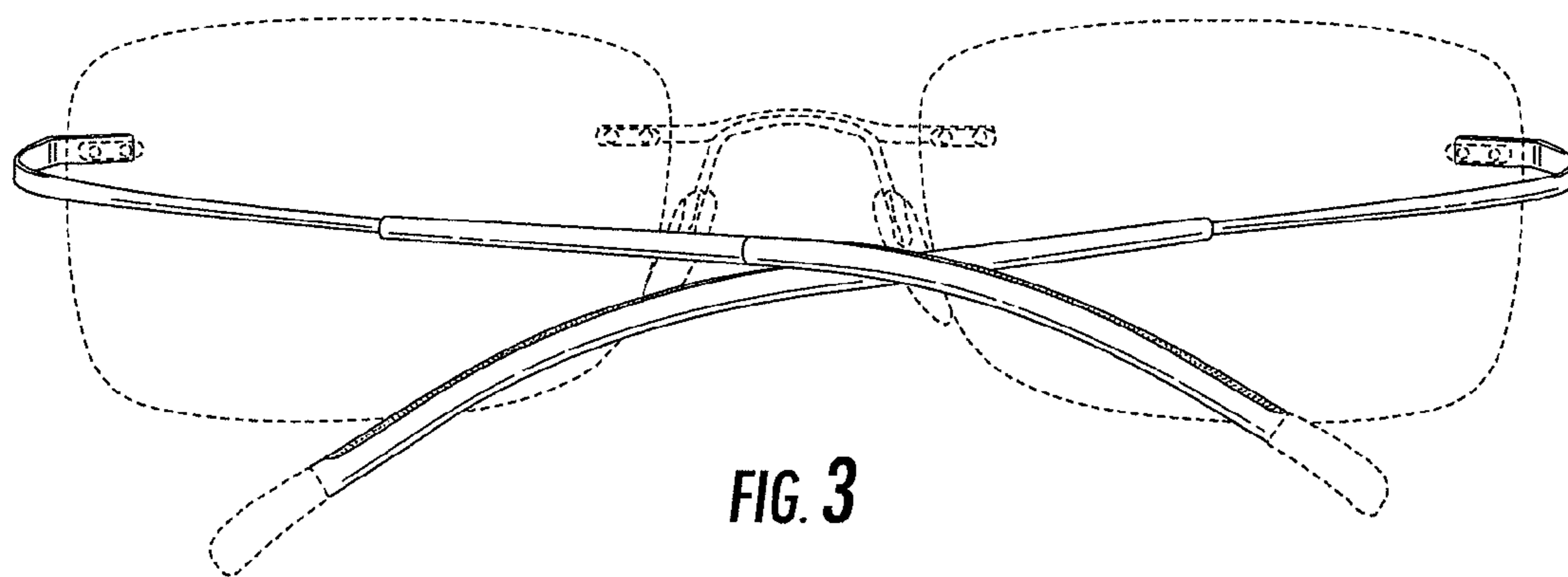

FIG. 3

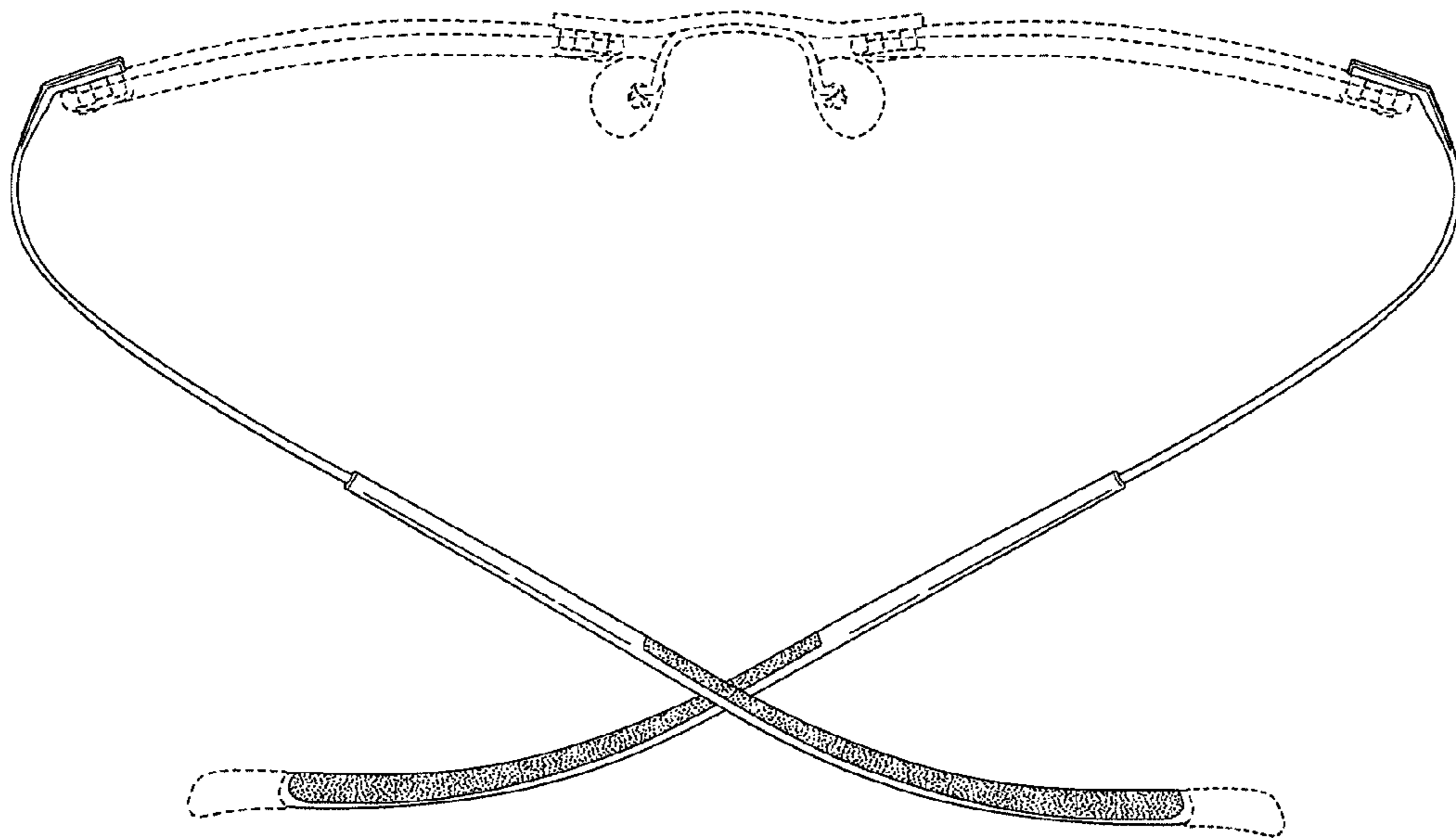

FIG. 4

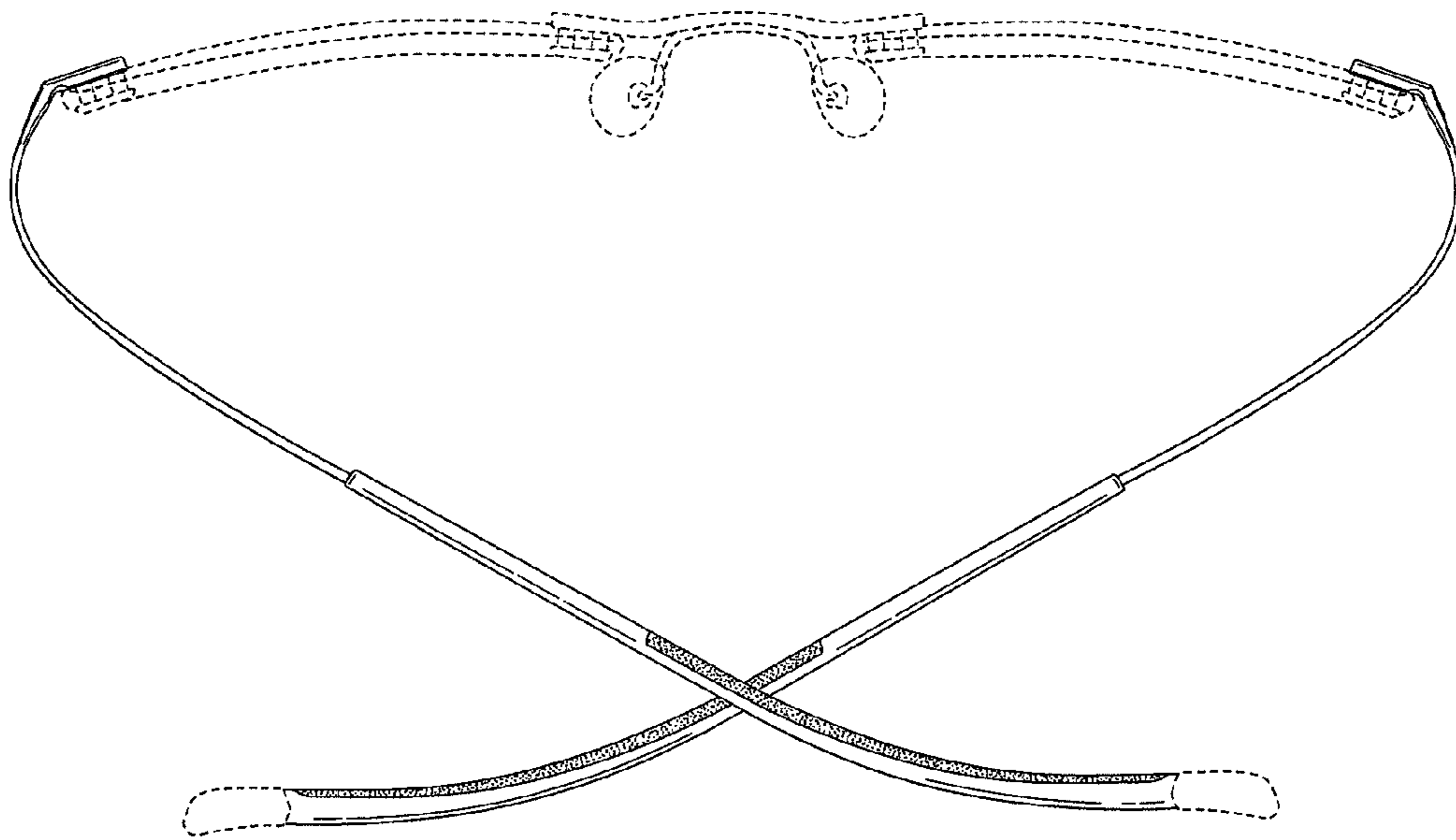

FIG. 5

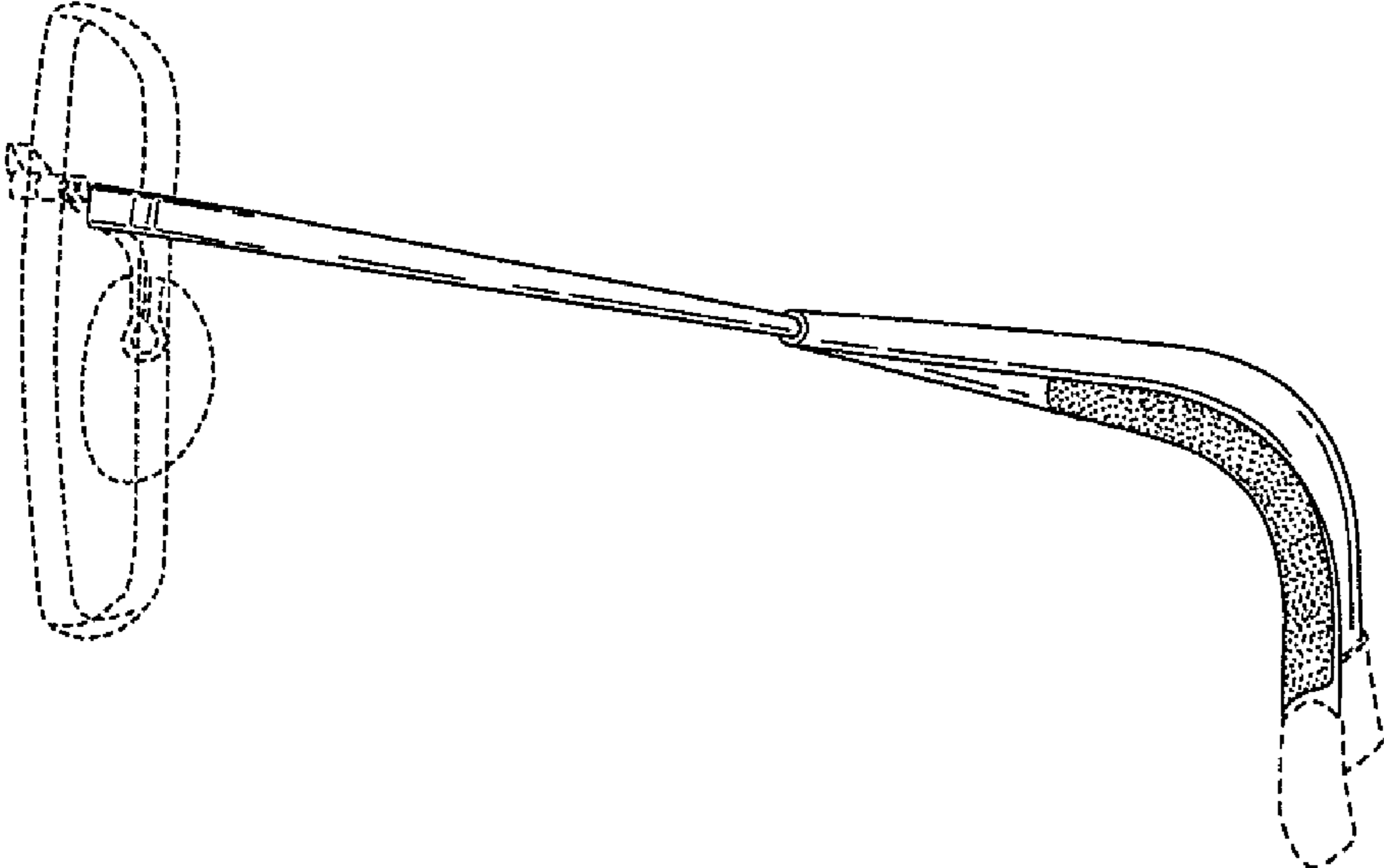

FIG. 6

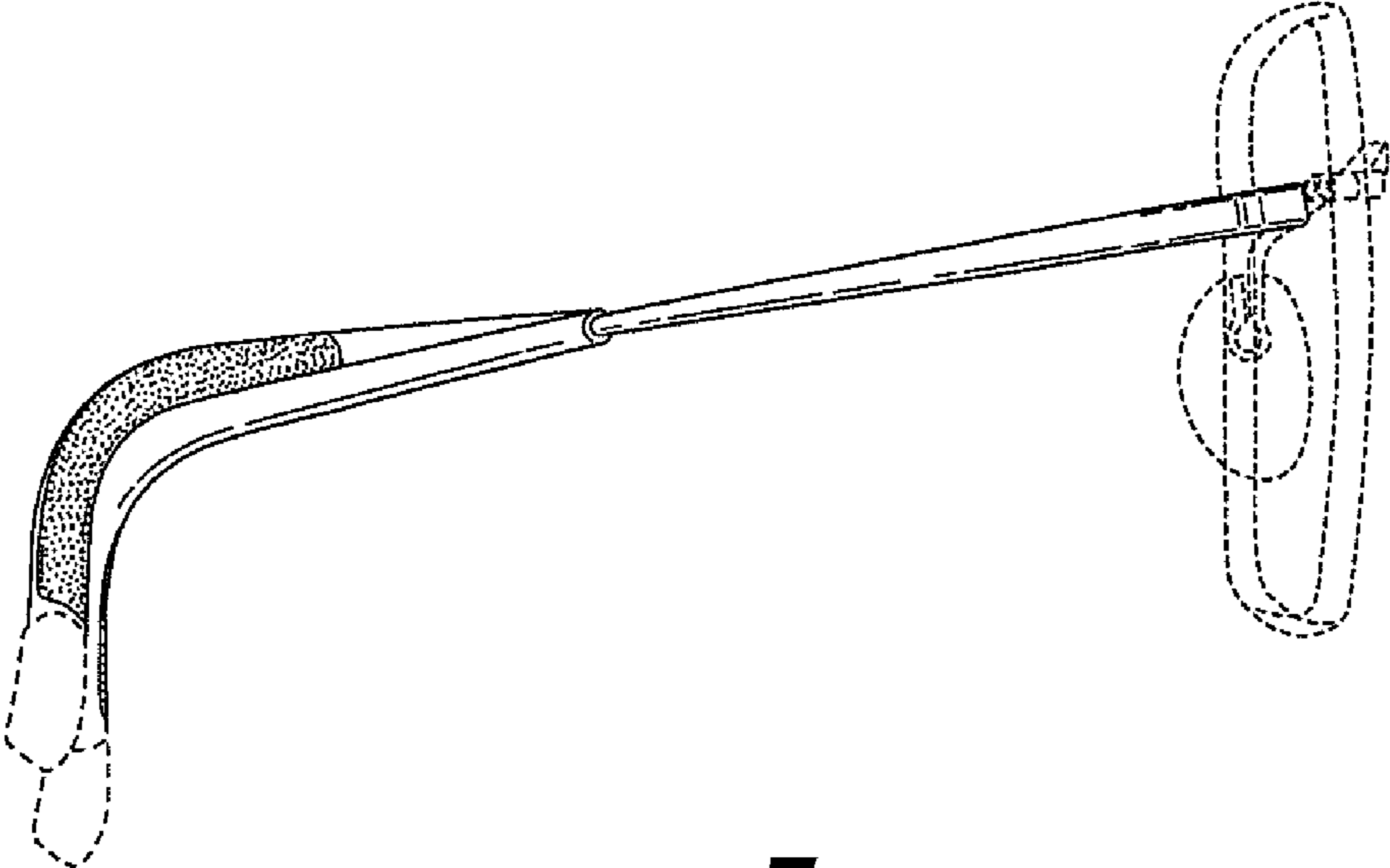

FIG. 7