



US00D678385S

(12) **United States Design Patent**
Turner

(10) **Patent No.:** **US D678,385 S**
(45) **Date of Patent:** **** Mar. 19, 2013**

(54) **SET OF INSTANT PHOTOGRAPH FILTERS**

(76) Inventor: **Arthur Turner**, Cincinnati, OH (US)

(**) Term: **14 Years**

(21) Appl. No.: **29/405,491**

(22) Filed: **Nov. 2, 2011**

(51) **LOC (9) Cl.** **16-05**

(52) **U.S. Cl.** **D16/237; D16/219**

(58) **Field of Classification Search** D16/134,
D16/136, 219, 237, 241, 250; D8/349, 350,
D8/351, 353, 354, 367, 371, 281, 403, 404;
D21/385, 386, 389, 478, 479, 480; 396/337,
396/340, 435, 545; 355/125

See application file for complete search history.

(56) **References Cited**

U.S. PATENT DOCUMENTS

D30,113 S *	1/1899	Phelps	D8/350
D33,779 S *	12/1900	Maddern et al.	D8/371
1,572,315 A *	2/1926	Scholl	396/340
3,088,390 A	5/1963	Zimmerman		
D246,346 S *	11/1977	Strunk	D8/354
D248,822 S *	8/1978	Taniwaki	D8/354
4,149,790 A	4/1979	Smith		
D260,233 S *	8/1981	Goldstein et al.	D8/351
D266,432 S *	10/1982	Cinque	D16/237
D266,433 S *	10/1982	Cinque	D16/237
4,392,731 A	7/1983	Van Heyningen		
D270,542 S *	9/1983	Cinque	D16/237
D275,551 S *	9/1984	Bigelow	D8/354
4,504,140 A *	3/1985	Filidei	355/71
D287,569 S *	1/1987	Shepard	D8/381
4,764,782 A	8/1988	Wheeler		
4,896,176 A	1/1990	Barrett		
5,247,320 A	9/1993	Kay		

D342,662 S *	12/1993	Lavin, Sr.	D8/354
D348,584 S	7/1994	Sankey		
5,546,151 A	8/1996	Fortson		
D376,750 S *	12/1996	Ferguson et al.	D8/354
D414,398 S *	9/1999	Benz et al.	D8/354
6,671,032 B2	12/2003	Meschter		
D500,666 S *	1/2005	Murphy et al.	D8/354
D500,667 S *	1/2005	Murphy et al.	D8/354
D503,330 S *	3/2005	Murphy et al.	D8/354
D567,639 S *	4/2008	McConnell et al.	D8/381
D599,643 S *	9/2009	Dinh	D8/354
D605,496 S *	12/2009	Scheuermann et al.	D8/349
D627,623 S *	11/2010	Densmore	D8/354
D639,142 S *	6/2011	Antonic	D8/354
5,680,197 A1	7/2011	Ikeda		
D647,385 S *	10/2011	Watts	D8/349
D647,783 S *	11/2011	Pelini	D8/349
D658,972 S *	5/2012	Virgin	D8/349

* cited by examiner

Primary Examiner — Philip S Hyder

Assistant Examiner — John T Applewhite

(57) **CLAIM**

I claim the ornamental design for the set of instant photograph filters, as shown and described.

DESCRIPTION

FIG. 1 is a front view of the set of instant photograph filters. FIG. 2 is a rear view of the claimed design. FIG. 3 is a right side view of the claimed design. FIG. 4 is a top view of the claimed design; and, FIG. 5 is an isometric view of one of the set of instant photograph filters in use with an instant photograph camera, which is depicted in broken lines and forms no part of the claimed design.

1 Claim, 4 Drawing Sheets

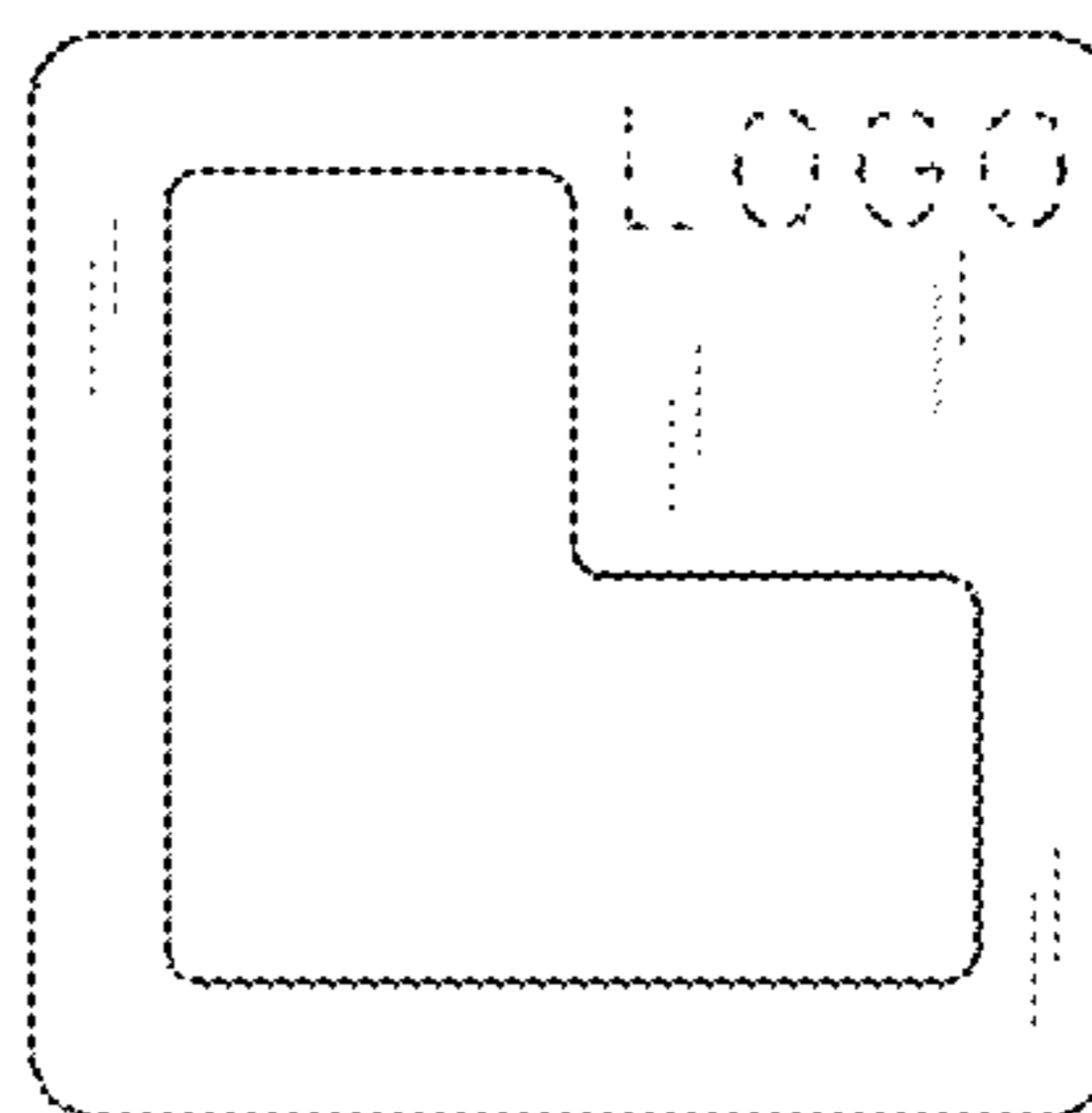
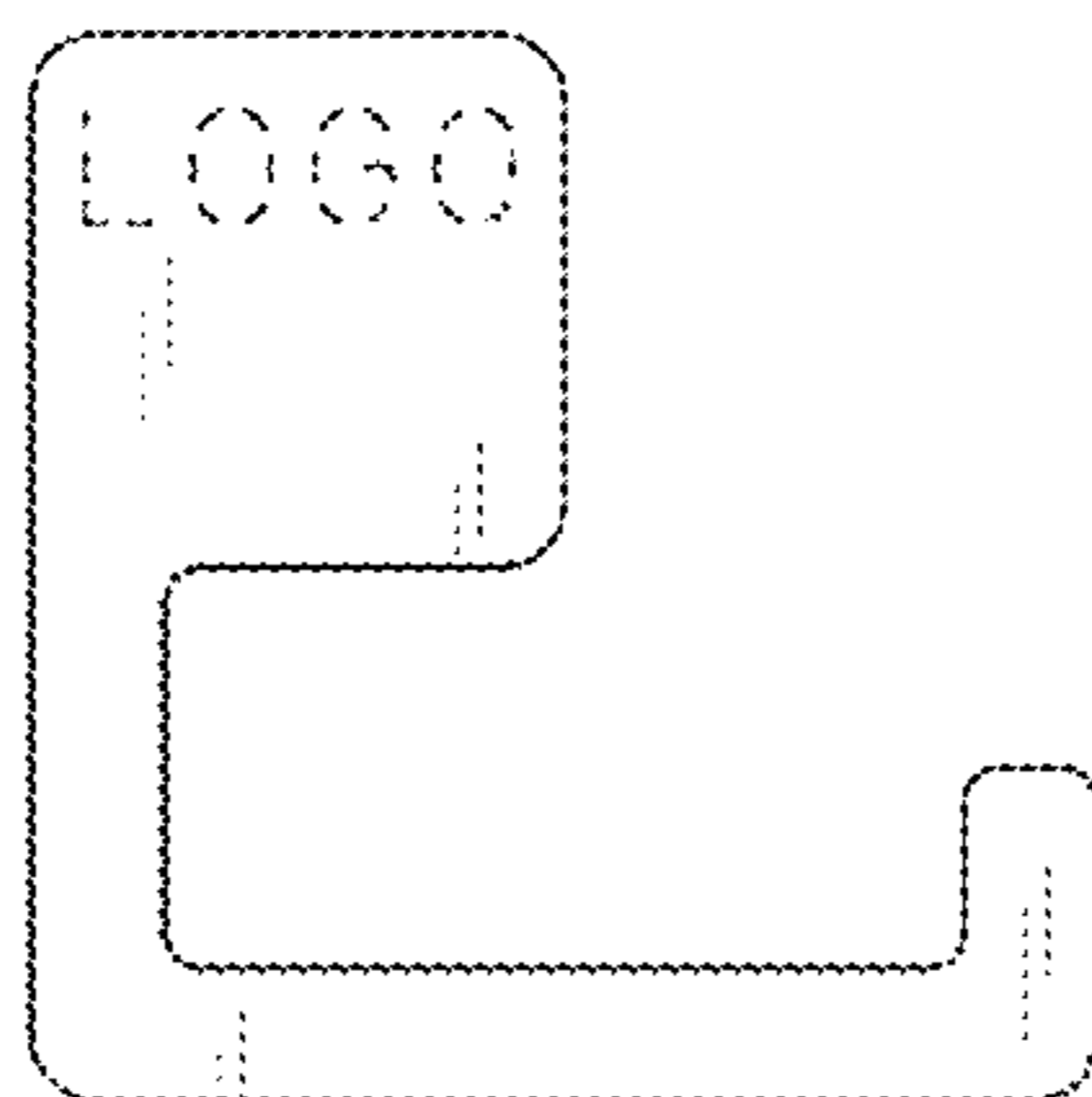
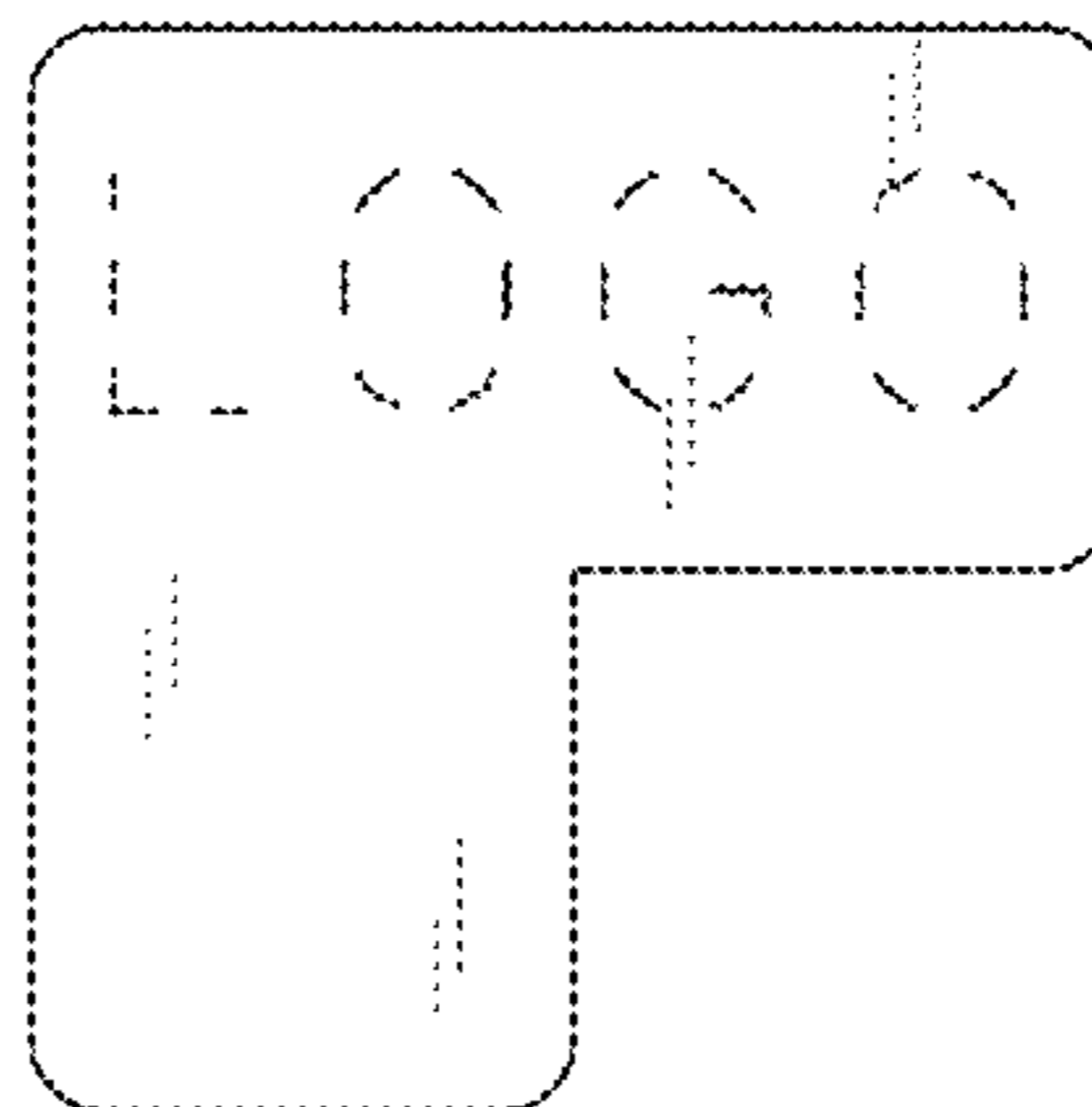
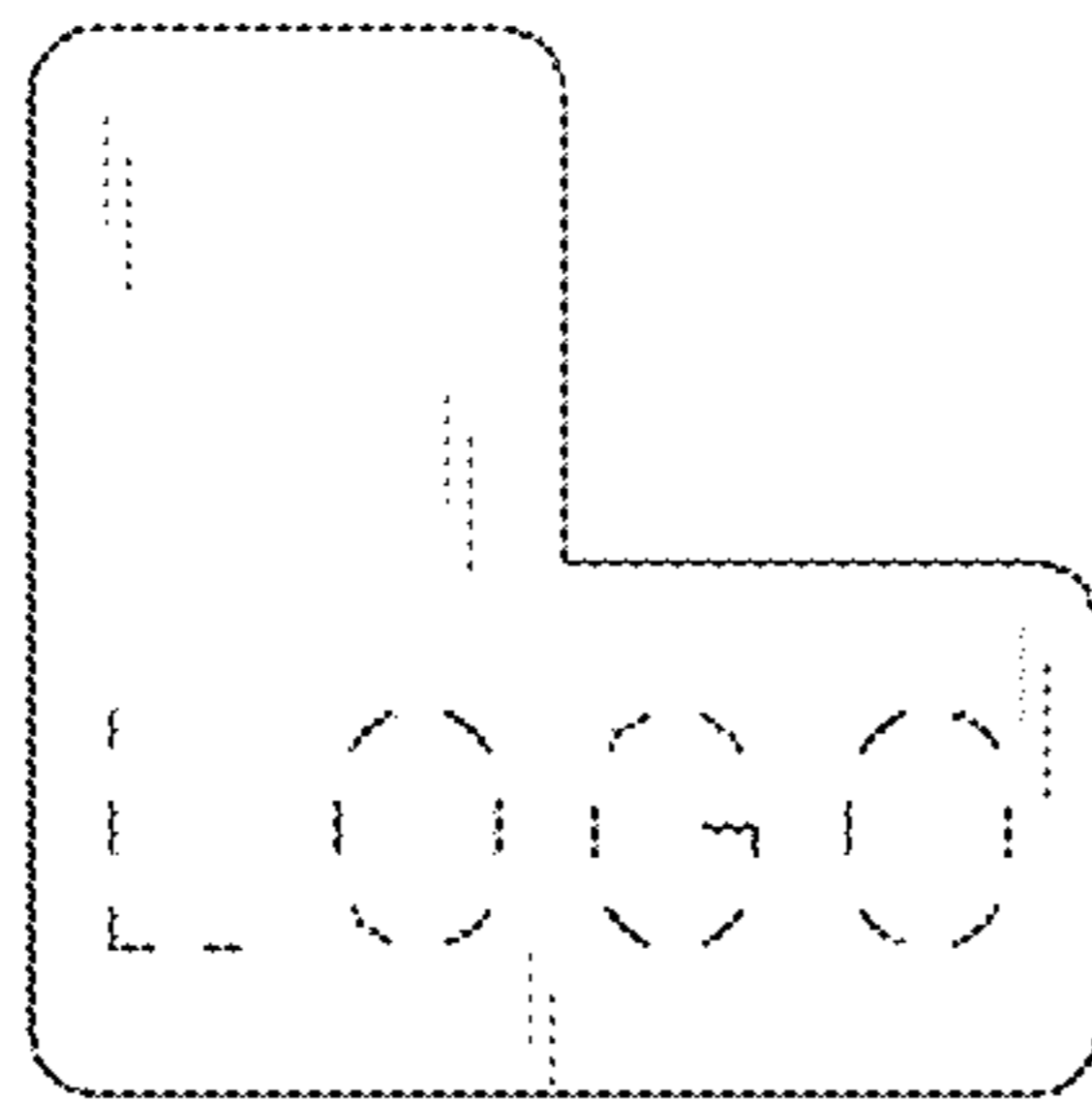

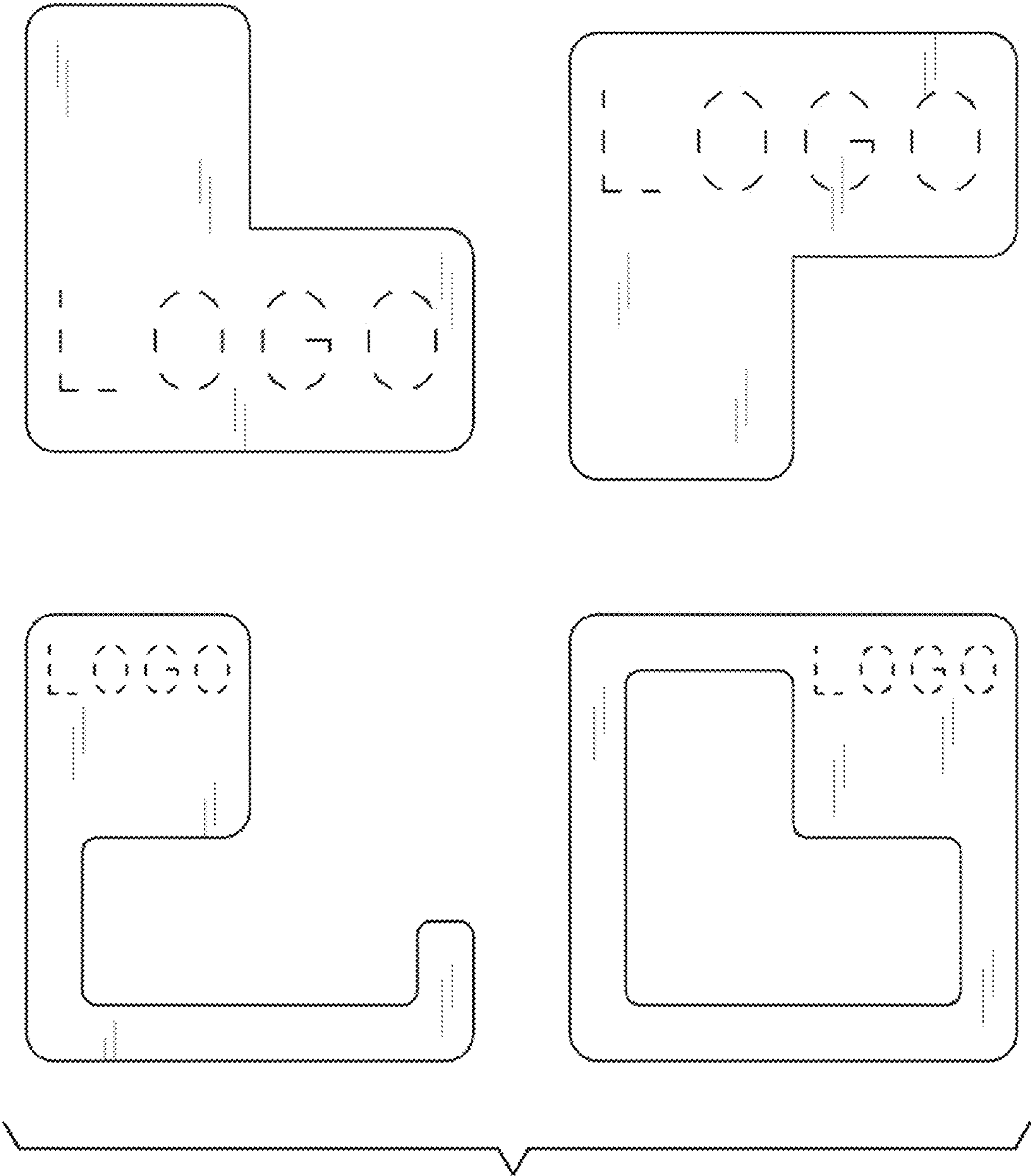

FIG. 1

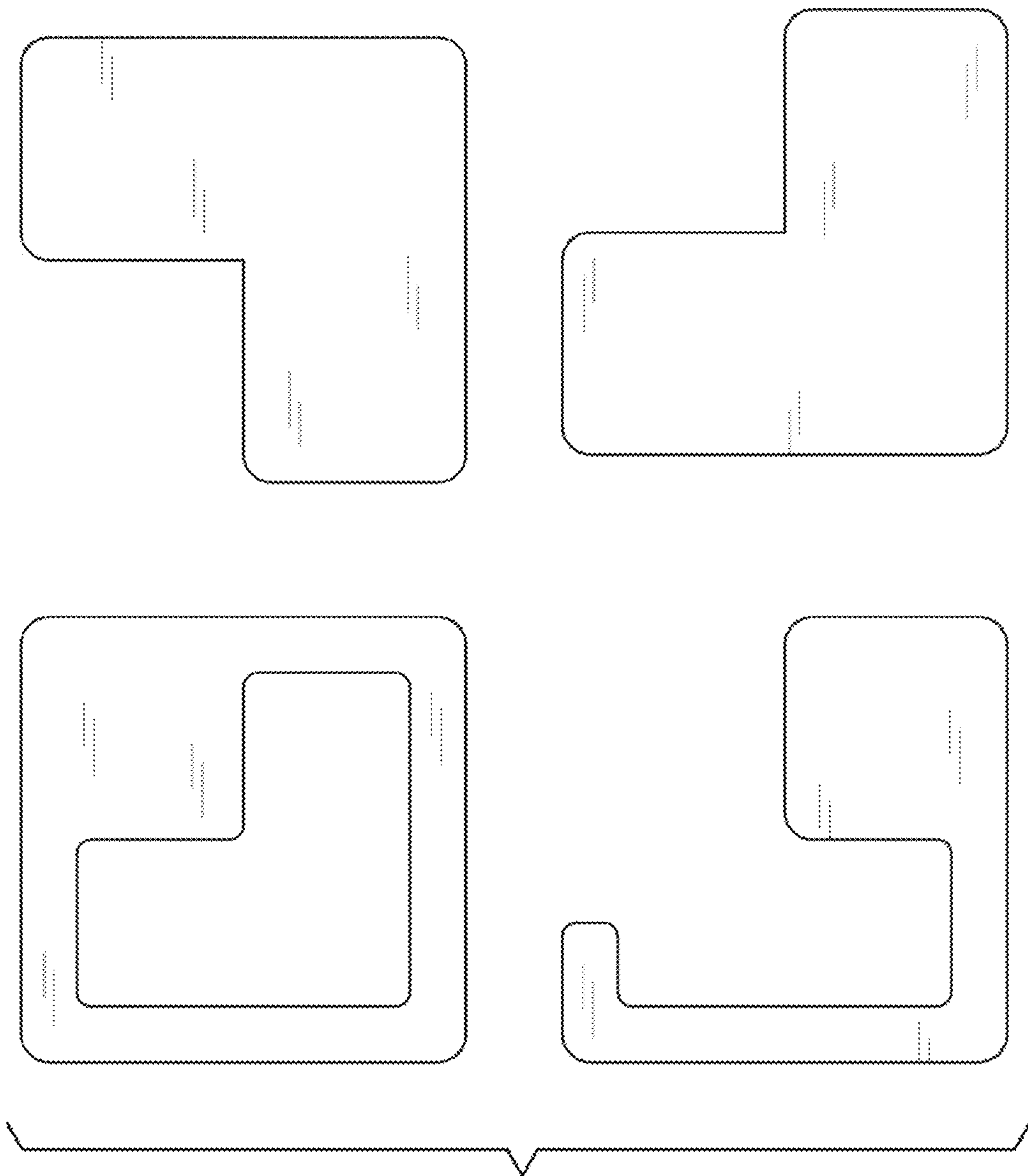

FIG. 2

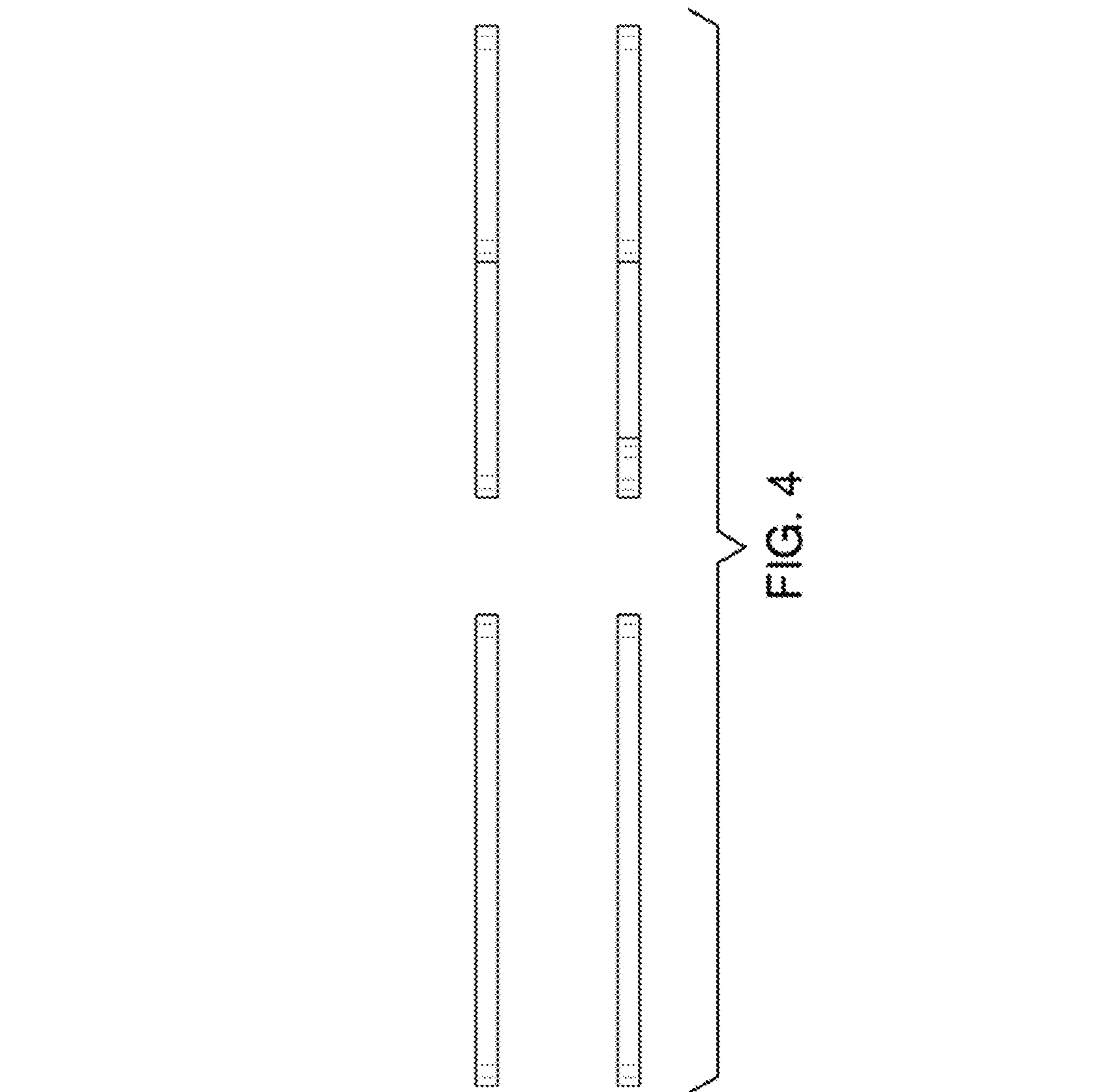

FIG. 3

FIG. 4

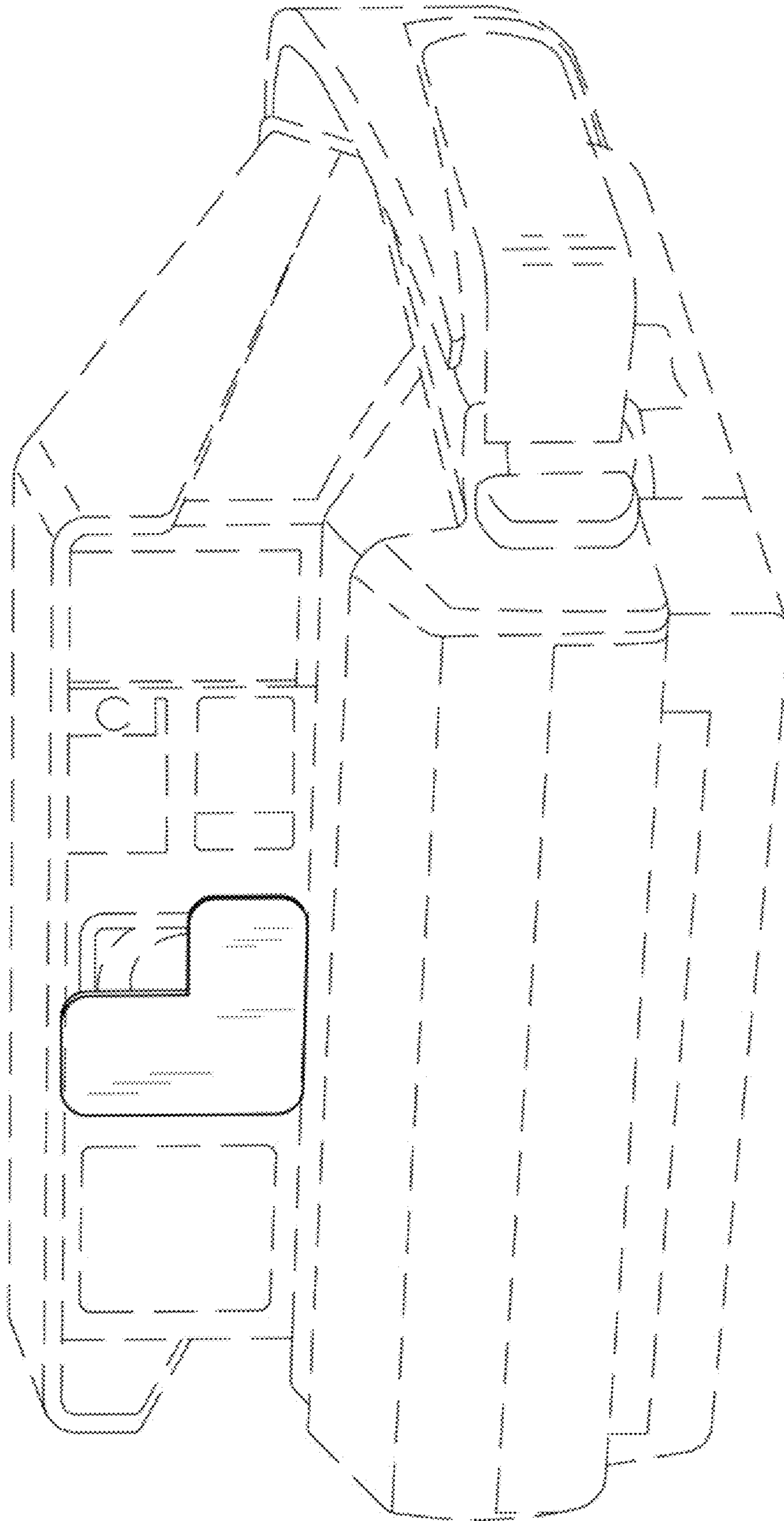

FIG. 5