



US00D678359S

(12) **United States Design Patent**
Hagura et al.

(10) **Patent No.:** **US D678,359 S**
(45) **Date of Patent:** **** Mar. 19, 2013**

(54) **COUNTERWEIGHT FOR CONSTRUCTION MACHINE**

(75) Inventors: **Shigehisa Hagura**, Akishima (JP);
Kazuhiko Hiraoka, Kodaira (JP);
Tomoyuki Miyata, Kodaira (JP);
Tomonori Mamada, Kazo (JP); **Makoto Matsushita**, Ushiku (JP)

(73) Assignee: **Hitachi Construction Machinery Co., Ltd.**, Tokyo (JP)

(**) Term: **14 Years**

(21) Appl. No.: **29/430,478**

(22) Filed: **Aug. 27, 2012**

(30) **Foreign Application Priority Data**

Mar. 15, 2012 (JP) 2012-005871

(51) **LOC (9) Cl.** **15-03**

(52) **U.S. Cl.** **D15/28**

(58) **Field of Classification Search** D15/10,
D15/22-26, 28, 30, 33; 296/193.03, 193.08;
172/611, 776; 180/69.24, 89.1, 89.12, 89.13,
180/900, 326; 37/443, 379; 414/601, 602,
414/685, 687, 688, 694, 722-724, 699, 680,
414/698, 719, 743

See application file for complete search history.

(56) **References Cited**

U.S. PATENT DOCUMENTS

5,715,615 A * 2/1998 Murakami et al. 37/379
D393,268 S * 4/1998 Tachinou et al. D15/28
D440,236 S * 4/2001 Kraft et al. D15/28
6,502,896 B1 * 1/2003 Nakata et al. 296/190.05
D490,444 S * 5/2004 Kuwae D15/33

D506,211 S * 6/2005 Kuwae et al. D15/33
7,036,251 B2 * 5/2006 Kojima et al. 37/466
D528,568 S * 9/2006 Kuwae et al. D15/28
D559,279 S * 1/2008 Sakitani et al. D15/28
D579,465 S * 10/2008 Ochi et al. D15/28
D582,947 S * 12/2008 Ueta et al. D15/28
D587,285 S * 2/2009 Murakami et al. D15/28
D632,703 S * 2/2011 Buhr et al. D15/28
2004/0200100 A1 * 10/2004 Kojima et al. 37/348

FOREIGN PATENT DOCUMENTS

CN 301611810 S 7/2011
JP D 1105851 S 4/2001
JP D 1327828 S 4/2008

OTHER PUBLICATIONS

U.S. Appl. No. 29/430,475, filed Aug. 27, 2012, Hiraoka.

* cited by examiner

Primary Examiner — Mark Goodwin

(74) *Attorney, Agent, or Firm* — Antonelli, Terry, Stout & Kraus, LLP.

(57) **CLAIM**

The ornamental design for a counterweight for construction machine, as shown and described.

DESCRIPTION

FIG. 1 is a front, top and right side perspective view of a counterweight for construction machine showing our/my new design;

FIG. 2 is a front elevational view thereof;

FIG. 3 is a rear elevational view thereof;

FIG. 4 is a left side elevational view thereof;

FIG. 5 is a right side elevational view thereof;

FIG. 6 is a top plan view thereof; and,

FIG. 7 is a bottom plan view thereof.

1 Claim, 4 Drawing Sheets

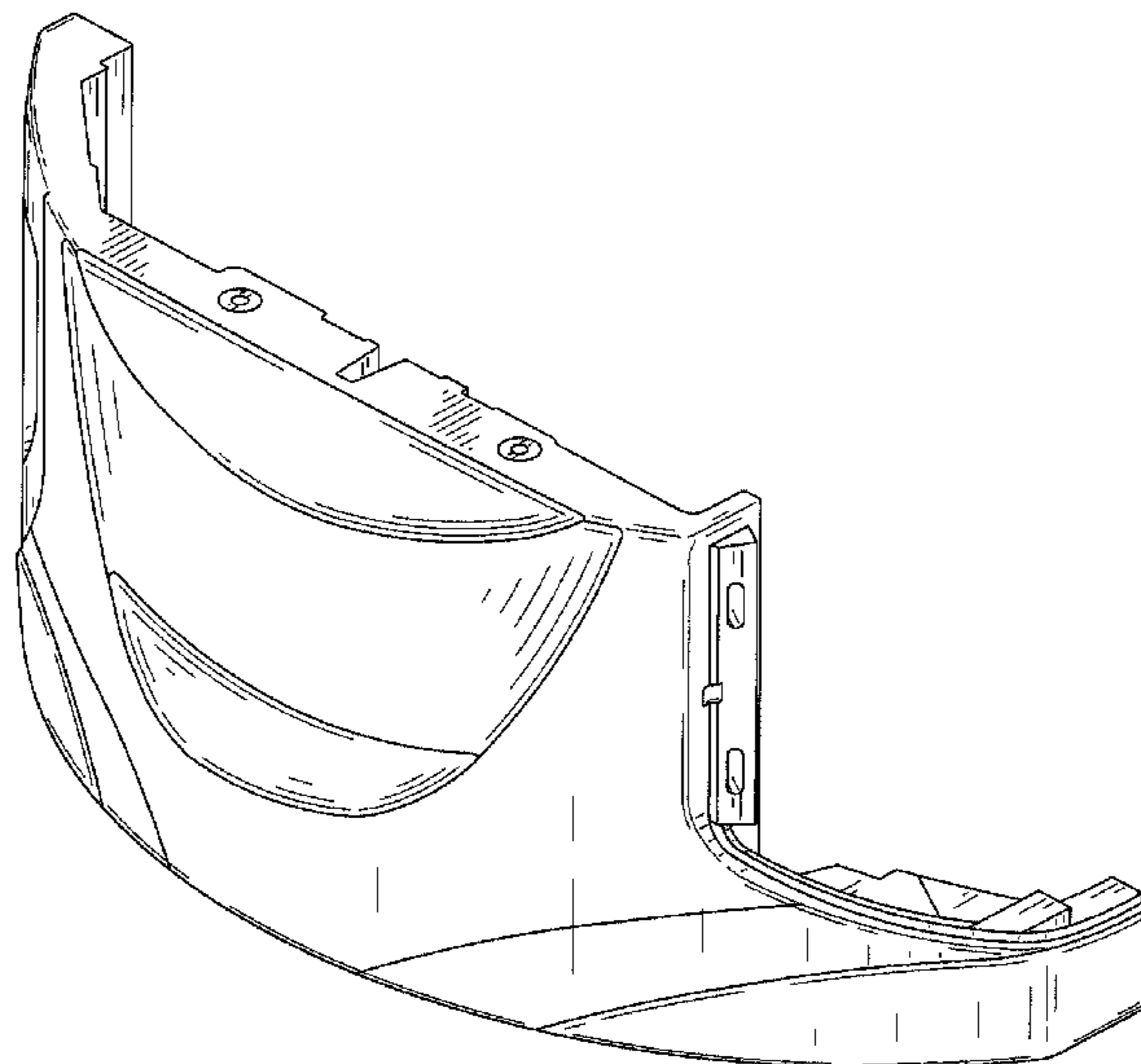

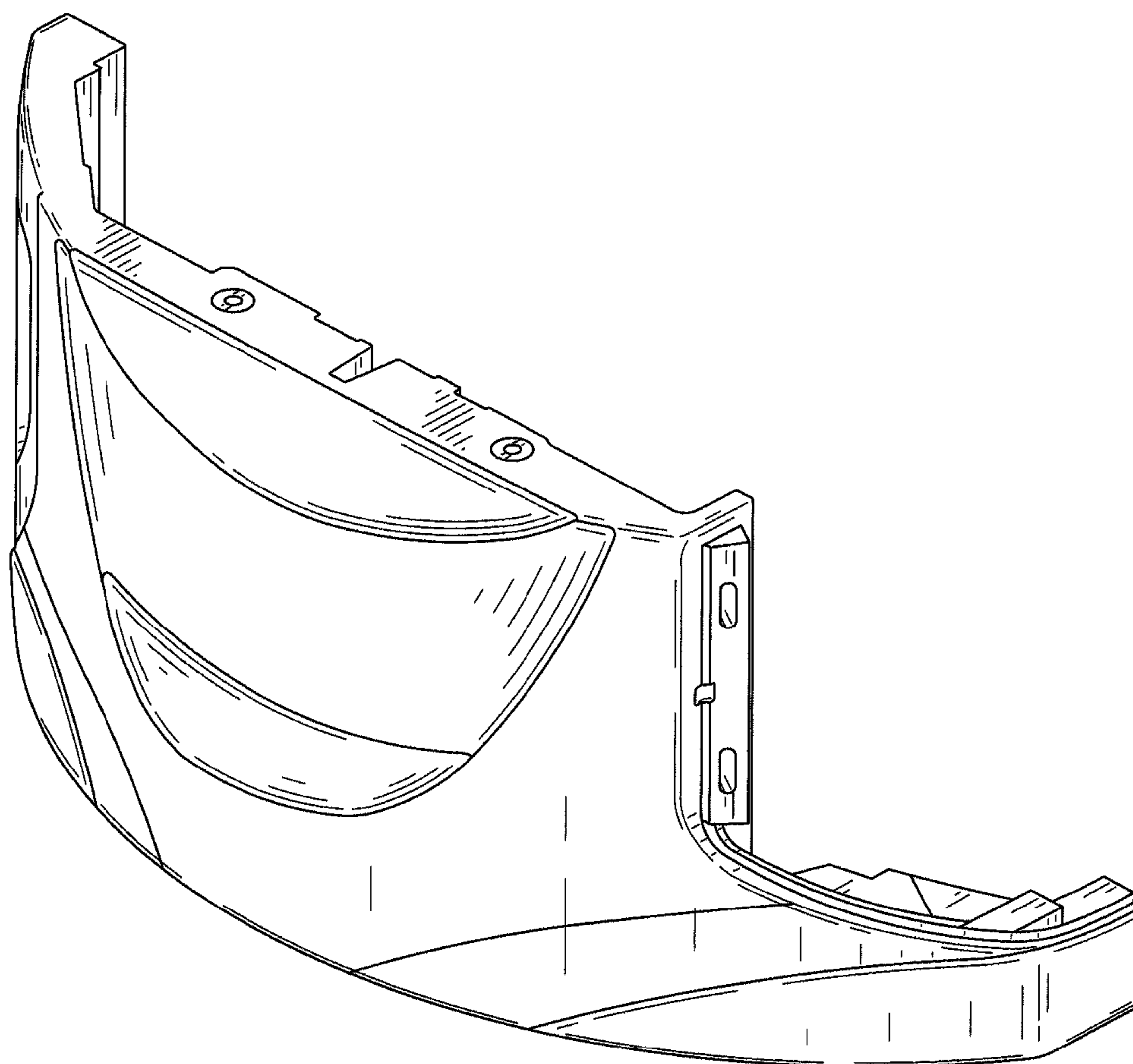

FIG. 1

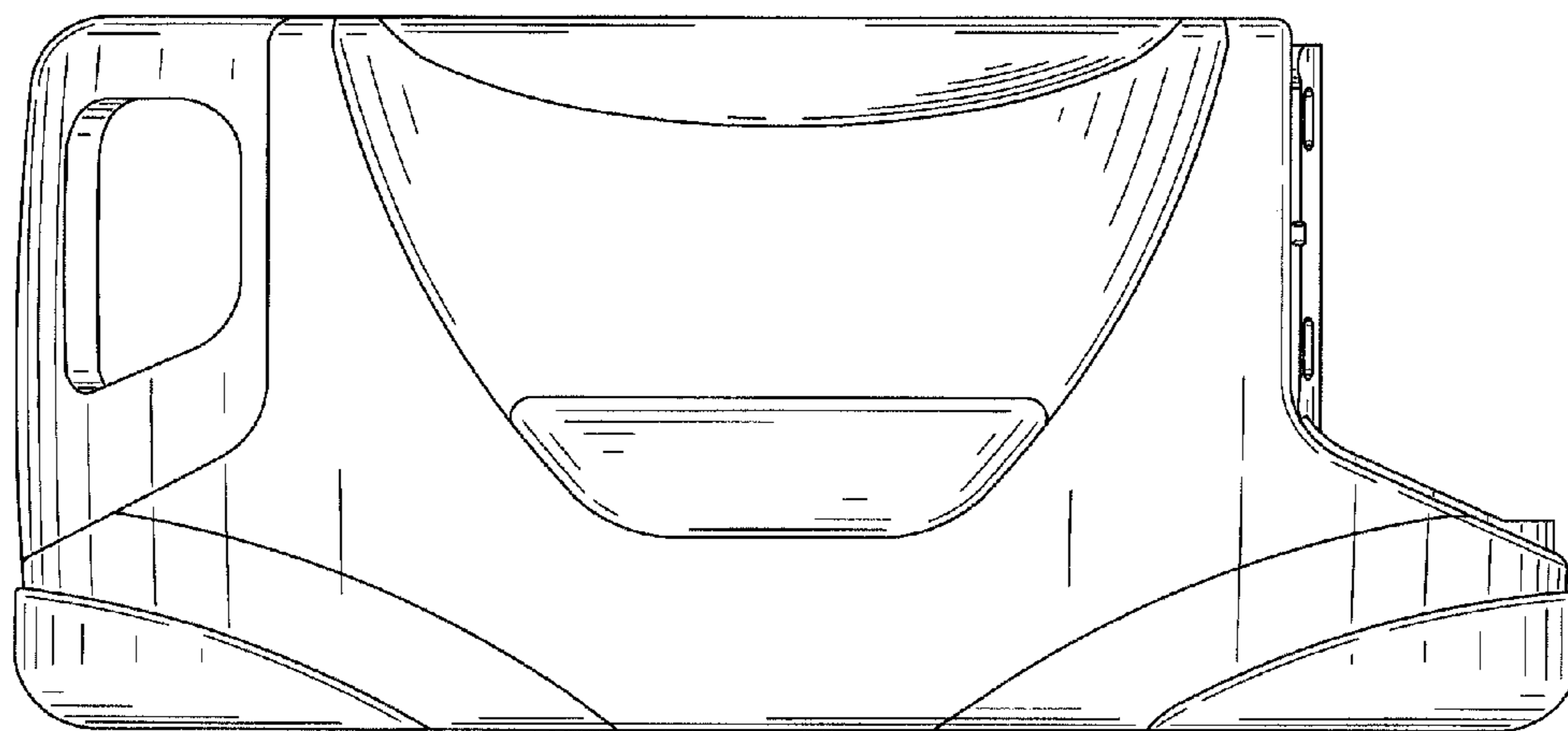

FIG. 2

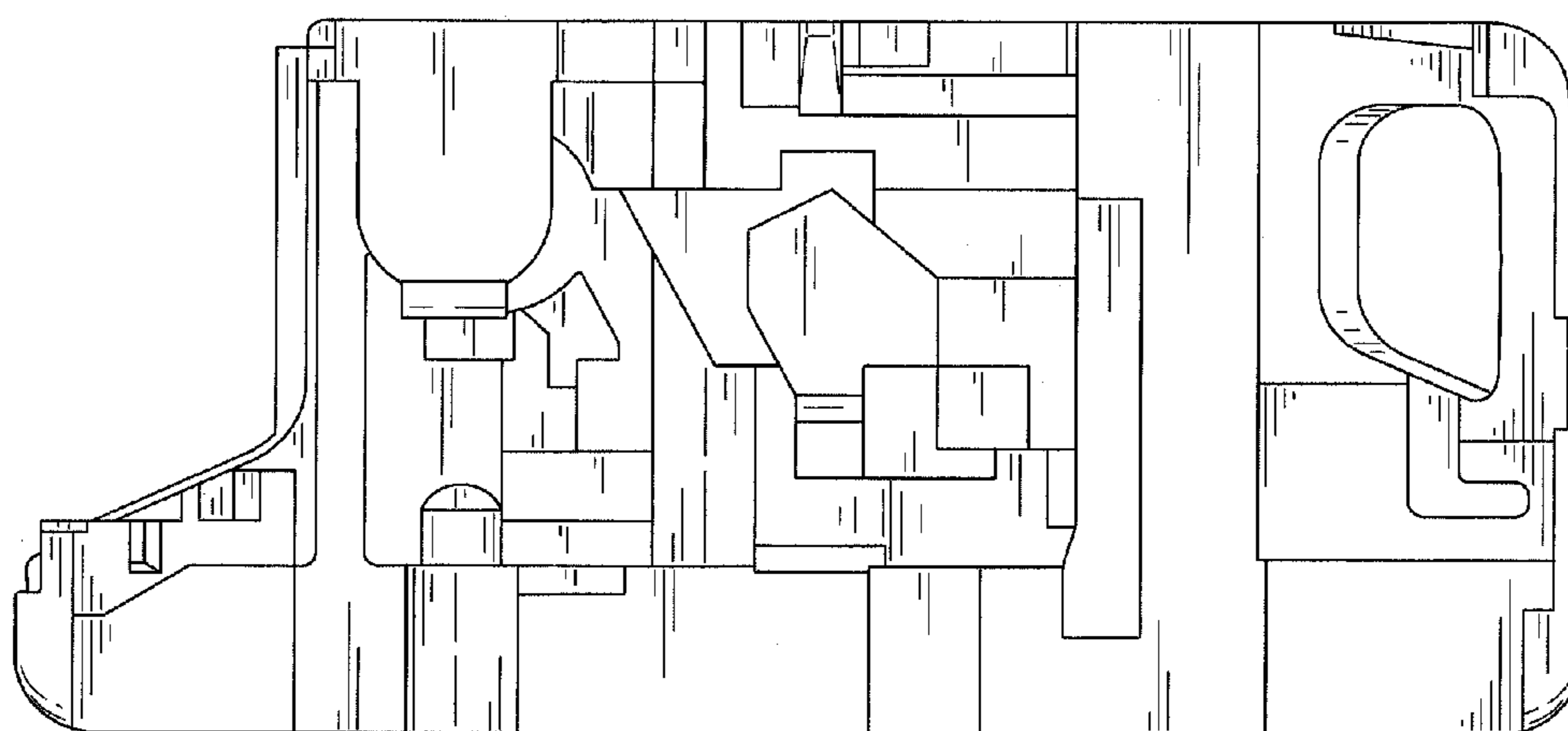

FIG. 3

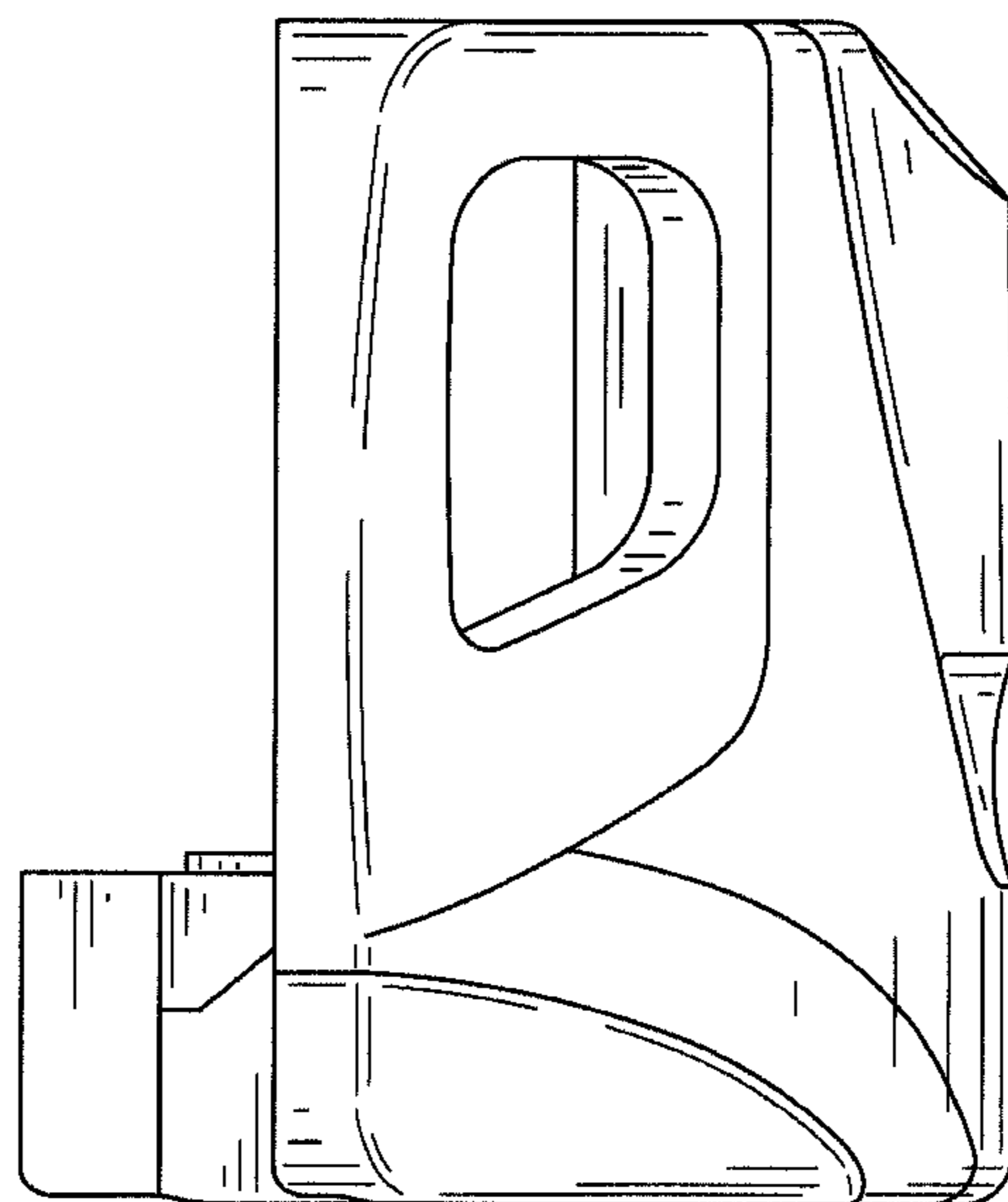

FIG. 4

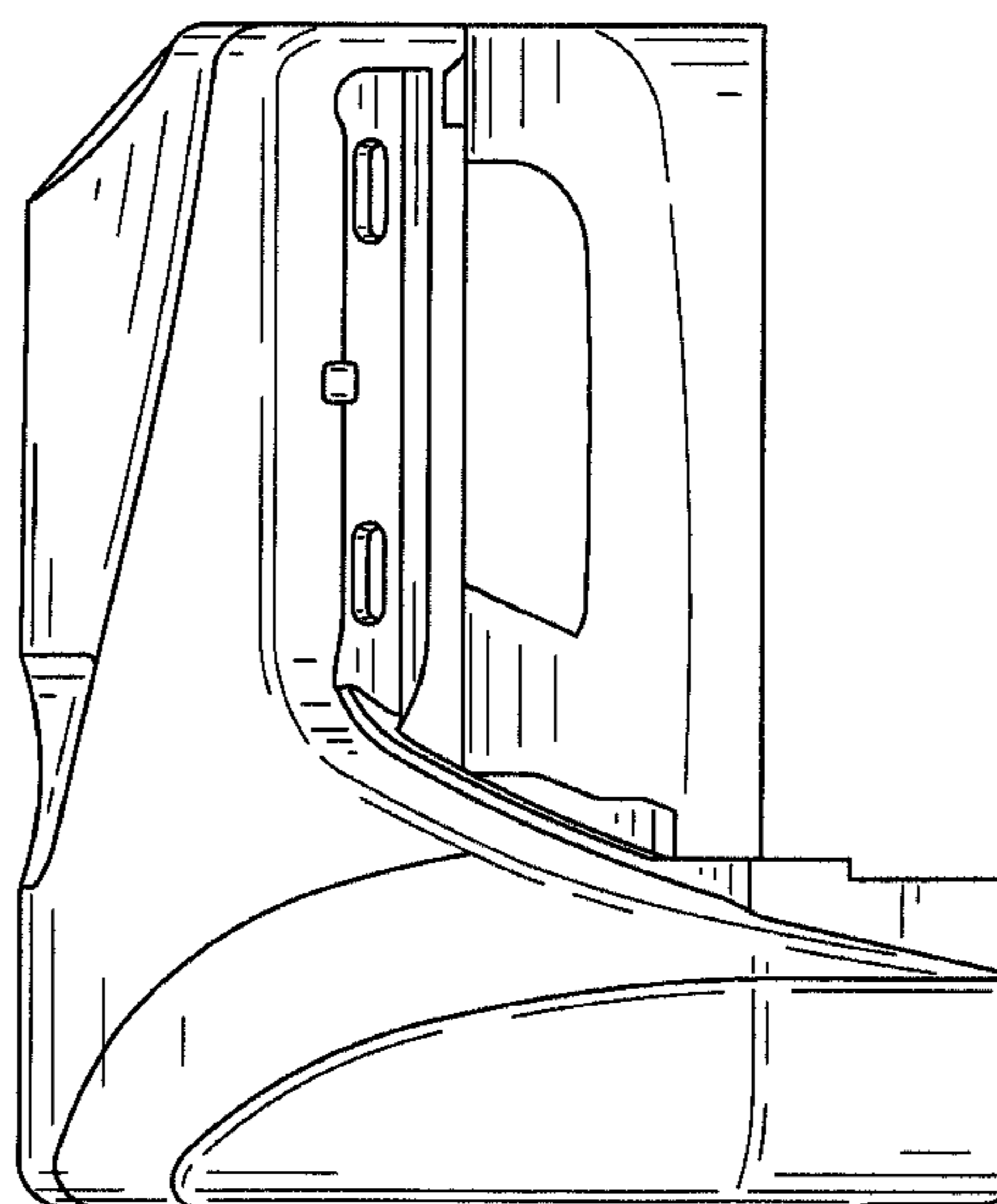

FIG. 5

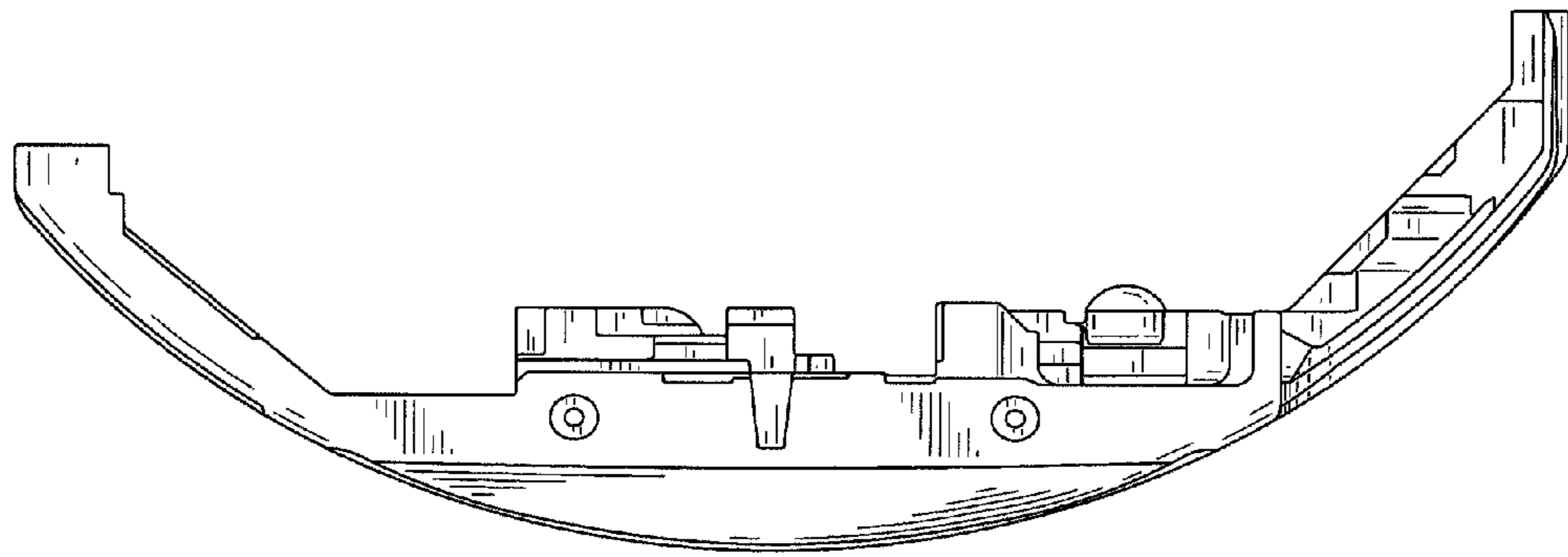

FIG. 6

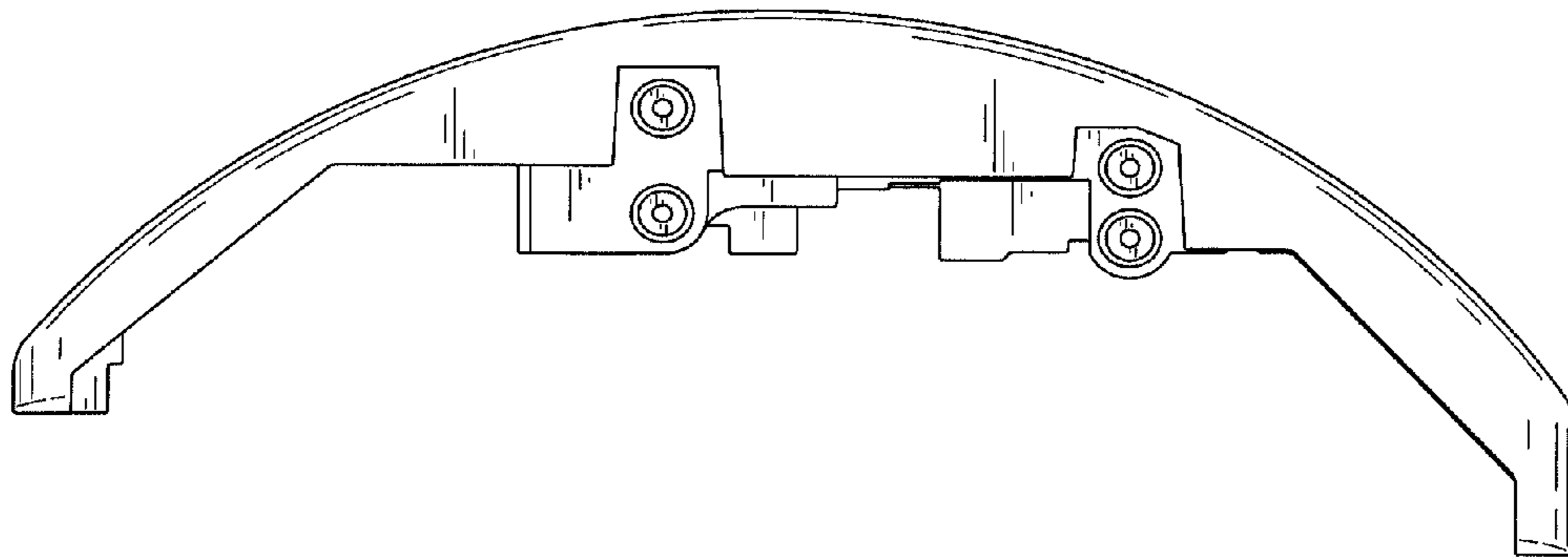

FIG. 7