



US00D678267S

(12) **United States Design Patent**
Ashcraft et al.

(10) **Patent No.:** **US D678,267 S**
(45) **Date of Patent:** **** Mar. 19, 2013**

(54) **COMPUTER**

(75) Inventors: **Britt C. Ashcraft**, Tomball, TX (US);
Eric Chen, Houston, TX (US);
Ruey-Jin Wong, New Taipei (TW)

(73) Assignee: **Hewlett-Packard Development Company, L.P.**, Houston, TX (US)

(**) Term: **14 Years**

(21) Appl. No.: **29/397,954**

(22) Filed: **Jul. 24, 2011**

(51) **LOC (9) Cl.** **14-02**

(52) **U.S. Cl.** **D14/315**

(58) **Field of Classification Search** D14/315-327;
D18/1, 2, 7, 11; 235/145 A, 145 R; 341/22,
341/23; 345/104, 156, 168, 169, 173; 361/679.08,
361/679.09, 679.11-679.17, 679.26, 679.27
See application file for complete search history.

(56) **References Cited**

U.S. PATENT DOCUMENTS

6,480,373 B1 * 11/2002 Landry et al. 361/679.06
D534,531 S * 1/2007 Ogasawara D14/318
D616,882 S * 6/2010 Denhez et al. D14/318

D617,789 S * 6/2010 Akana et al. D14/318

* cited by examiner

Primary Examiner — Freda S Nunn

(57) **CLAIM**

We claim the ornamental design for a computer, as shown and described.

DESCRIPTION

FIG. 1 is a front perspective view of a computer;
FIG. 2 is a top plan view of the computer of FIG. 1;
FIG. 3 is an enlarged fragmentary view of the computer of FIG. 1 taken along line 3-3 of FIG. 2;
FIG. 4 is an enlarged fragmentary sectional view of the computer of FIG. 3 taken along line 4-4;
FIG. 5 is an alternate front perspective view of the computer of FIG. 1;
FIG. 6 is a top plan view of the computer of FIG. 5;
FIG. 7 is an alternate front perspective view of the computer of FIG. 1; and,
FIG. 8 is a top plan view of the computer of FIG. 7.
The dash-dash broken lines in the drawings are environmental lines which do not form part of the claimed design.

1 Claim, 7 Drawing Sheets

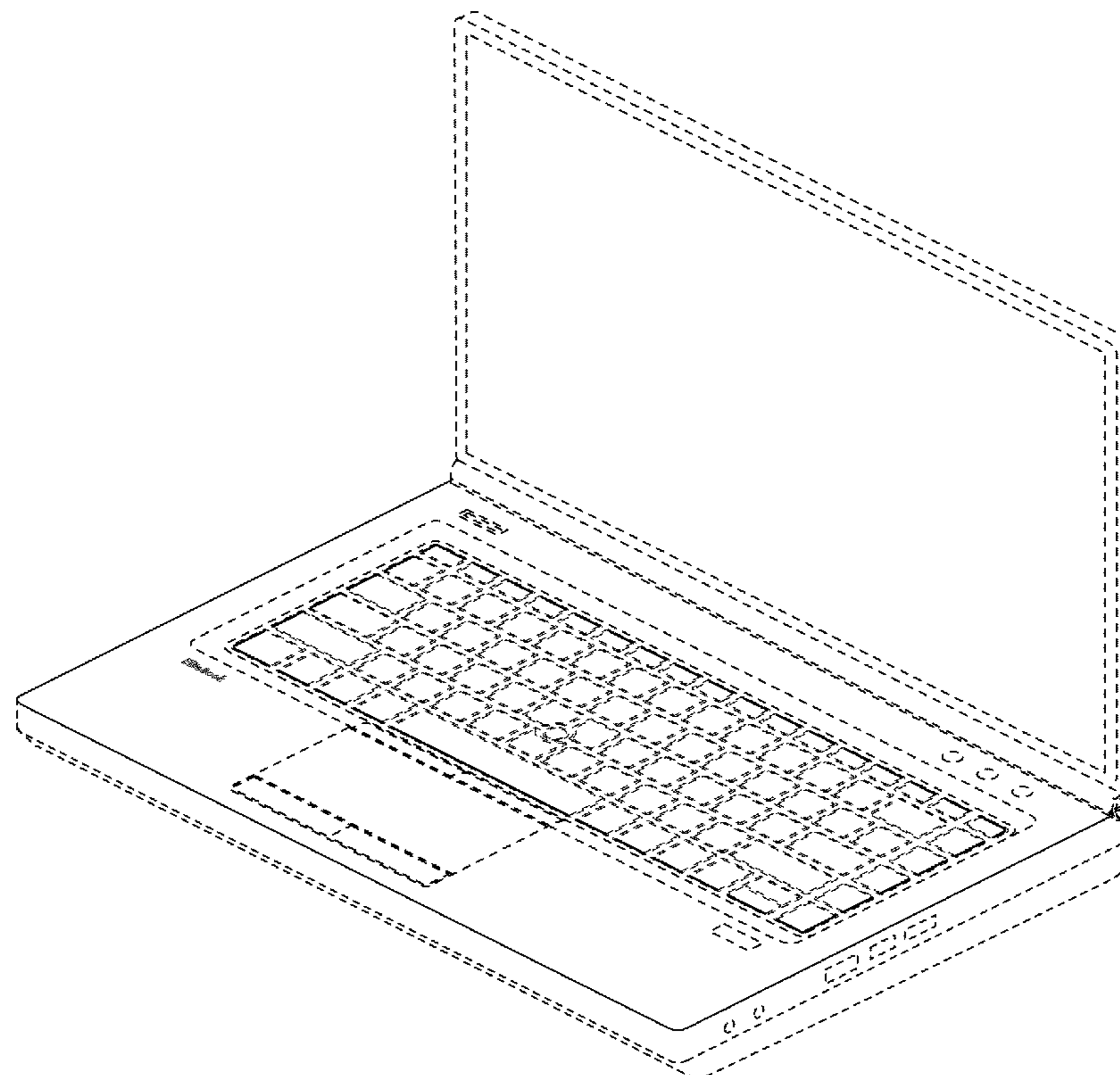

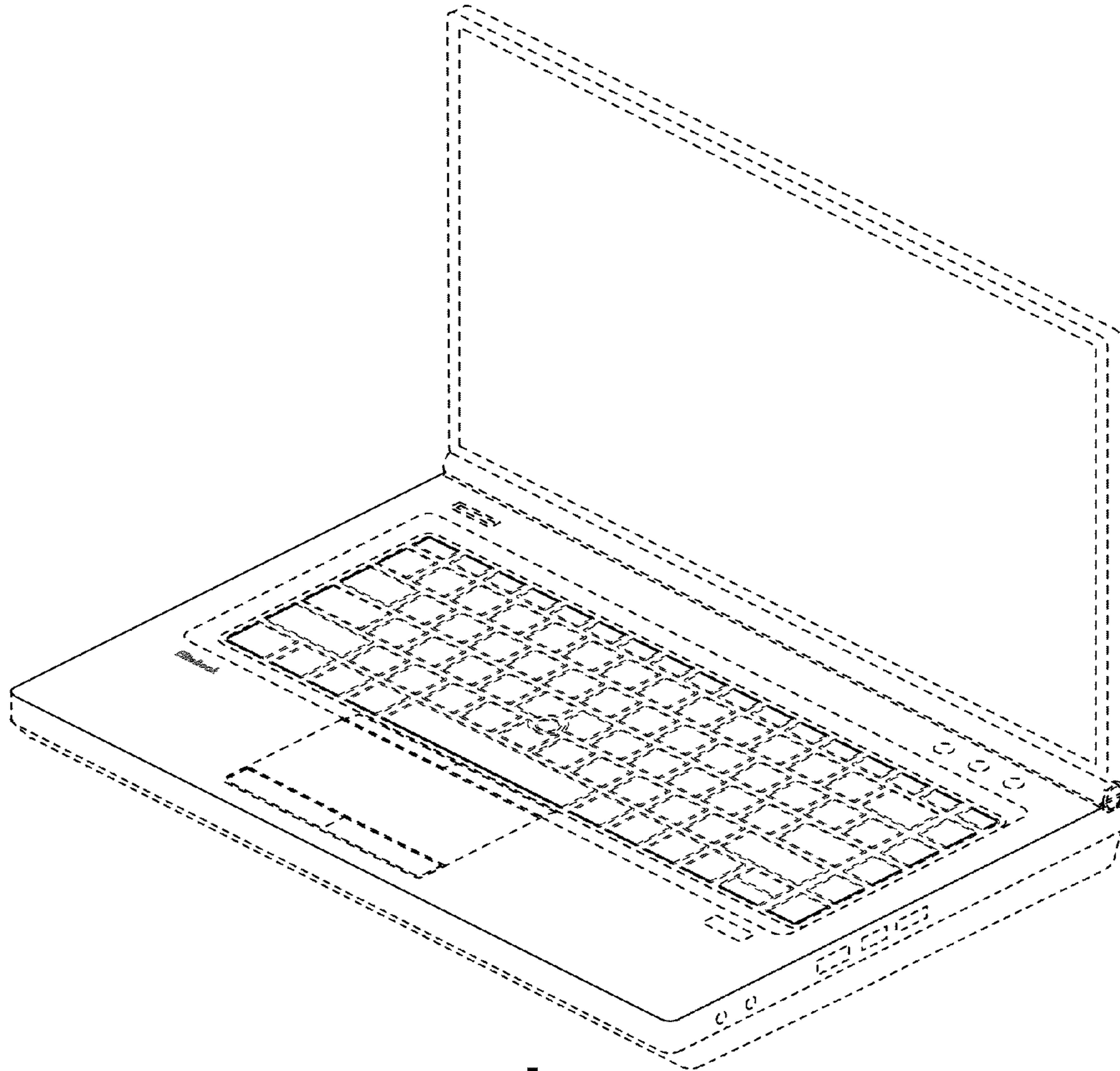
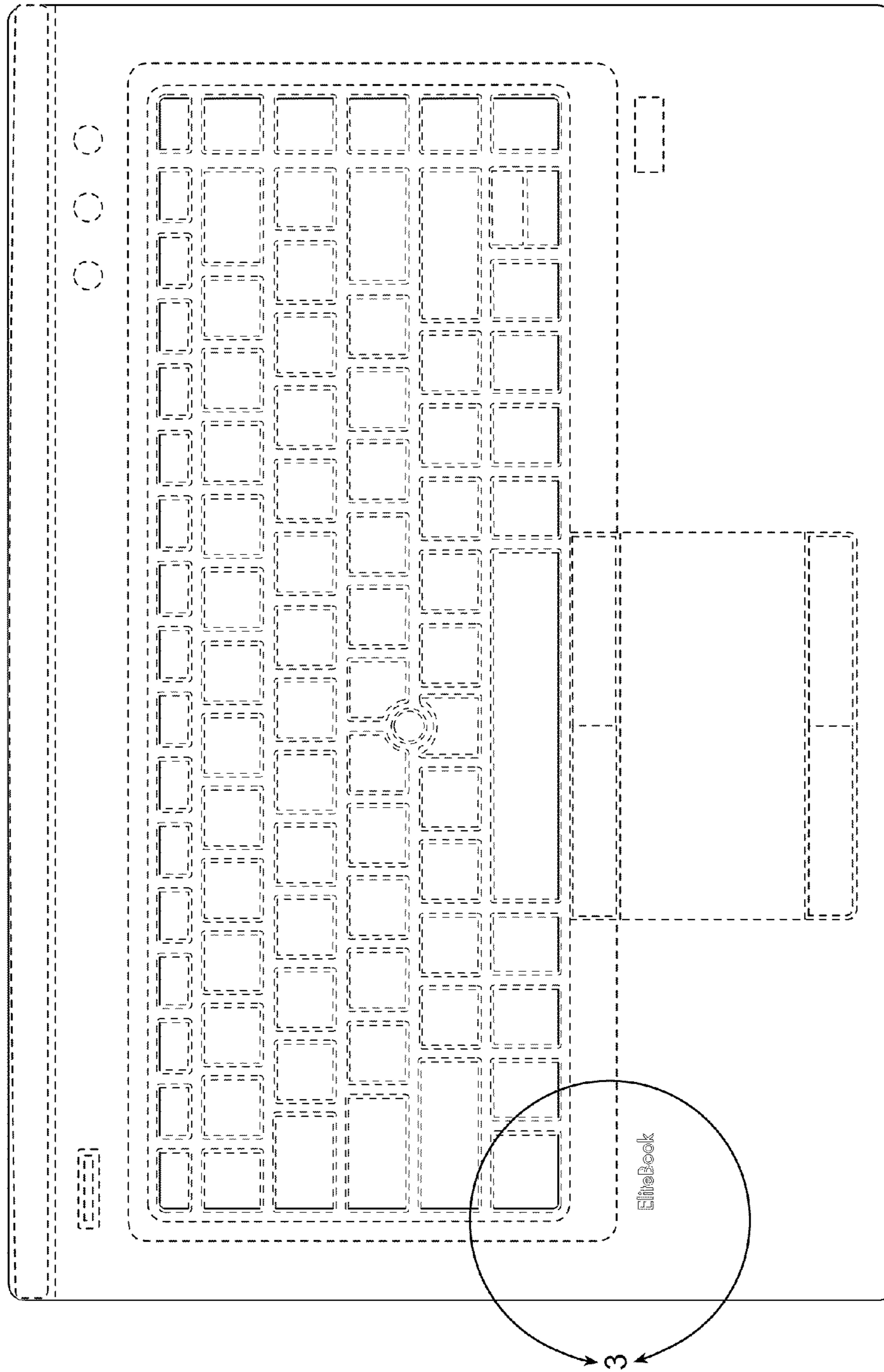

FIG. 1



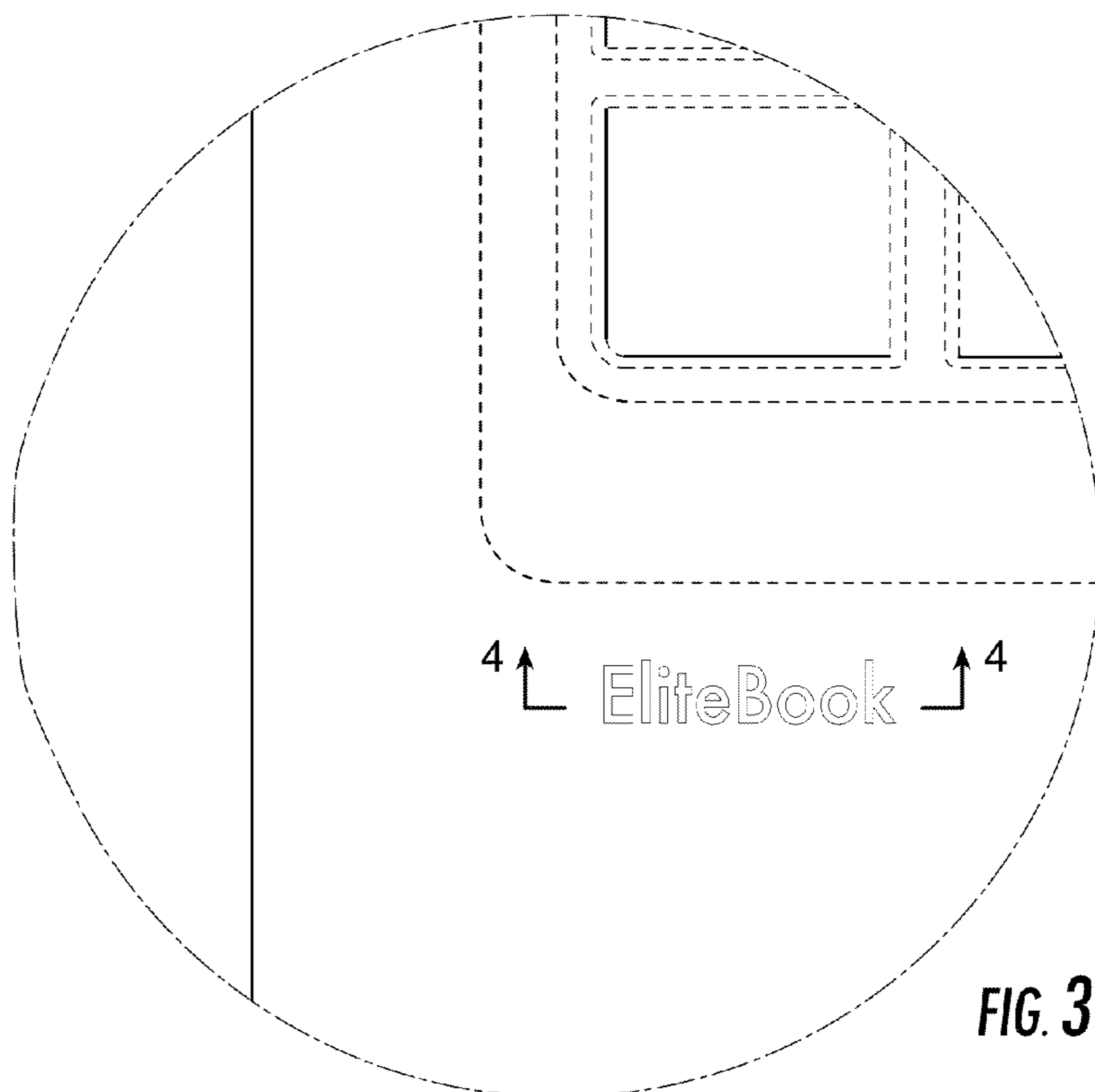

FIG. 3

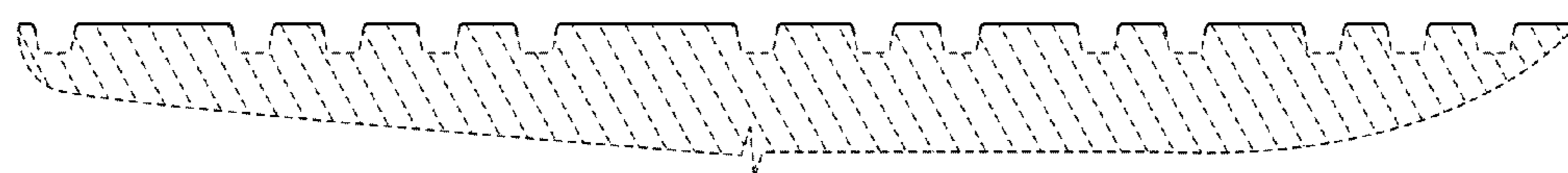

FIG. 4

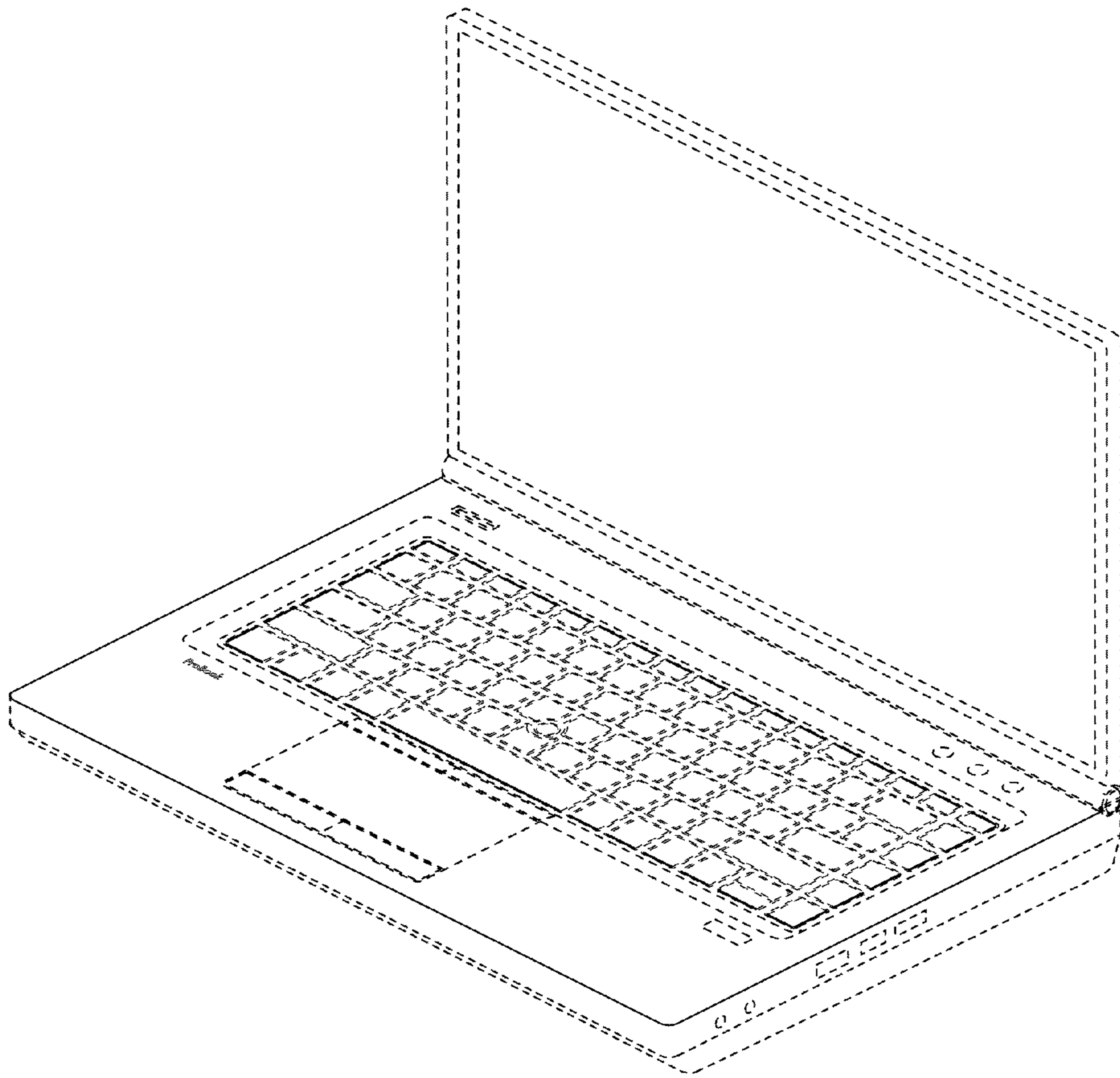

FIG. 5

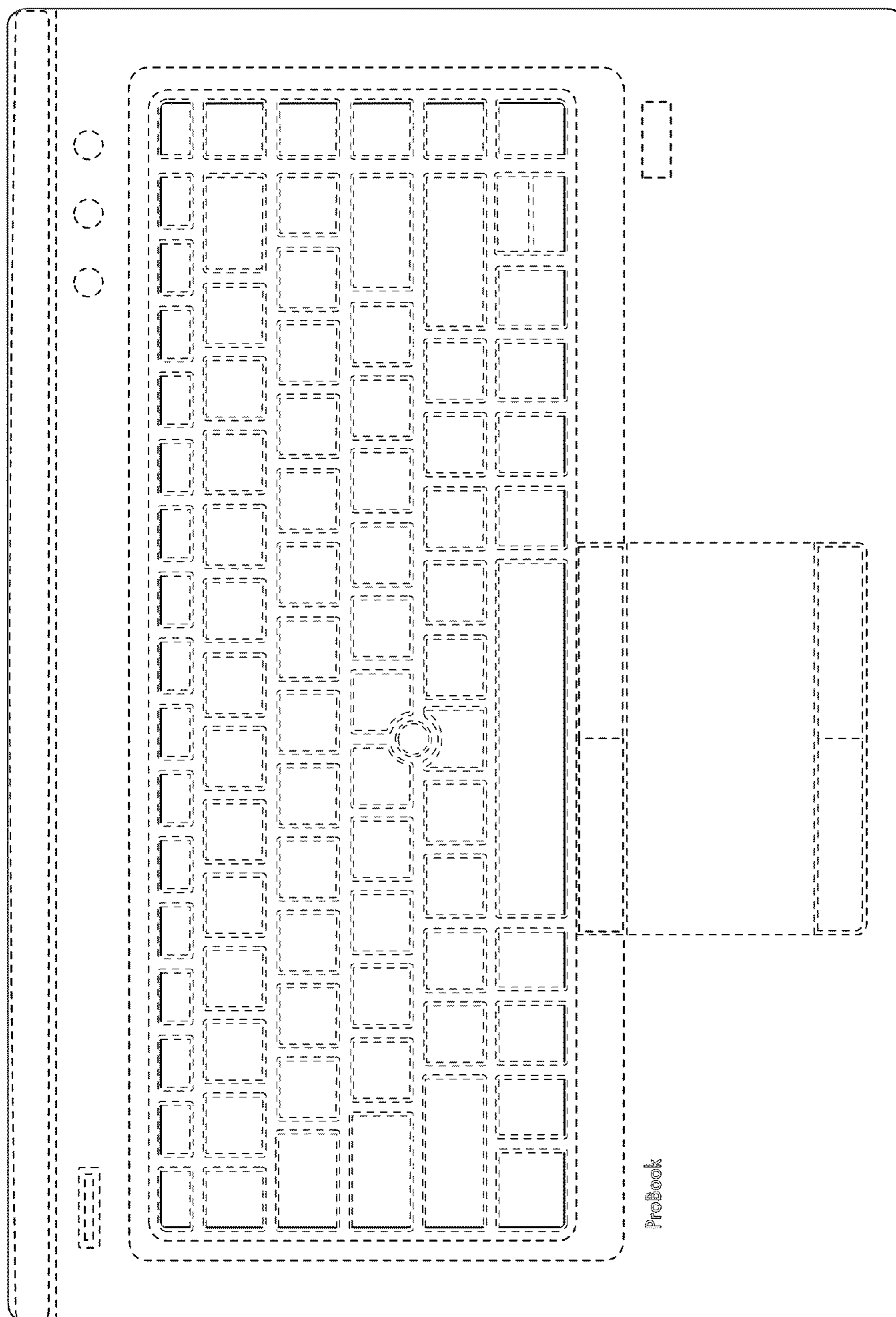

FIG. 6

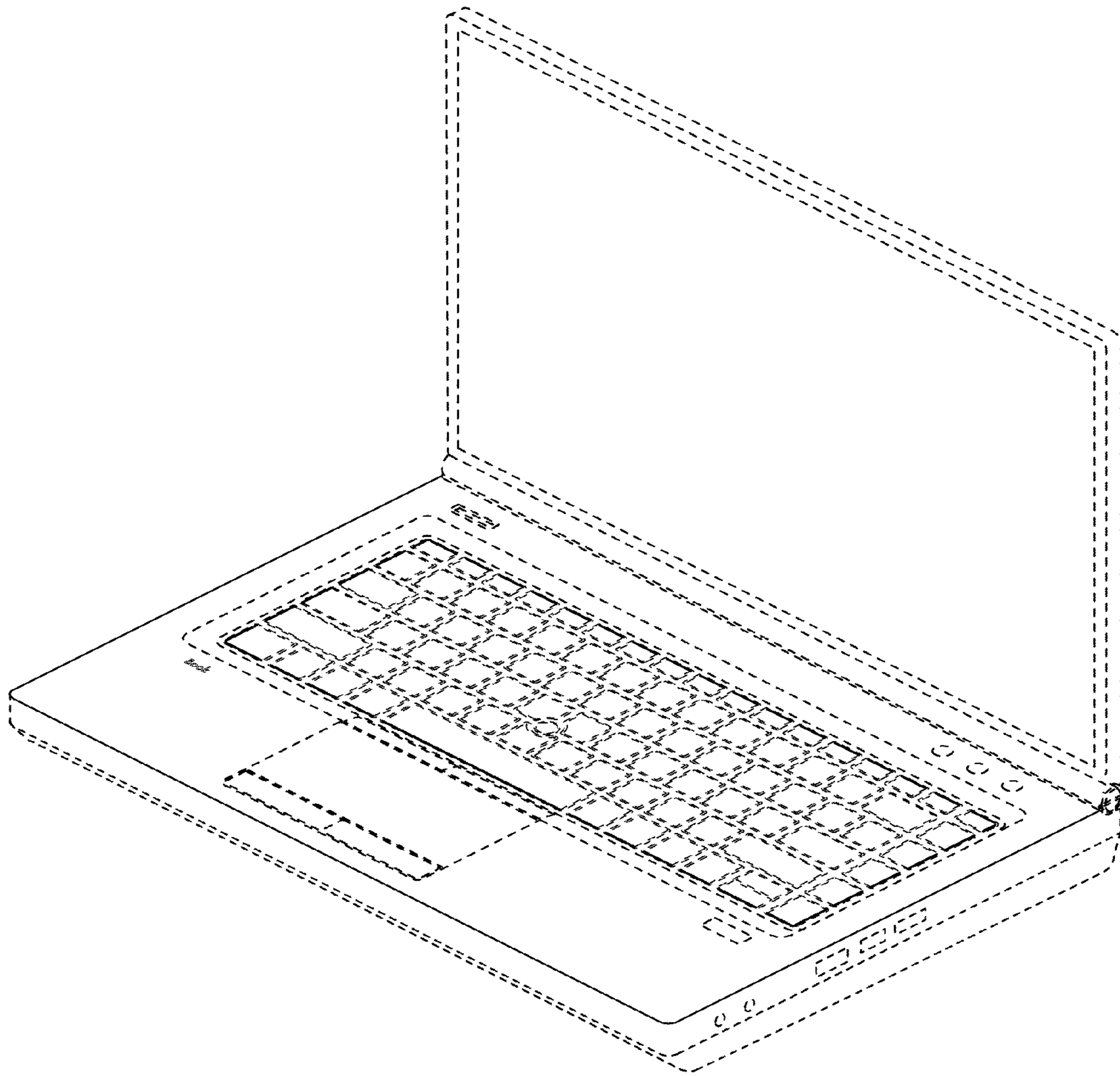

FIG. 7

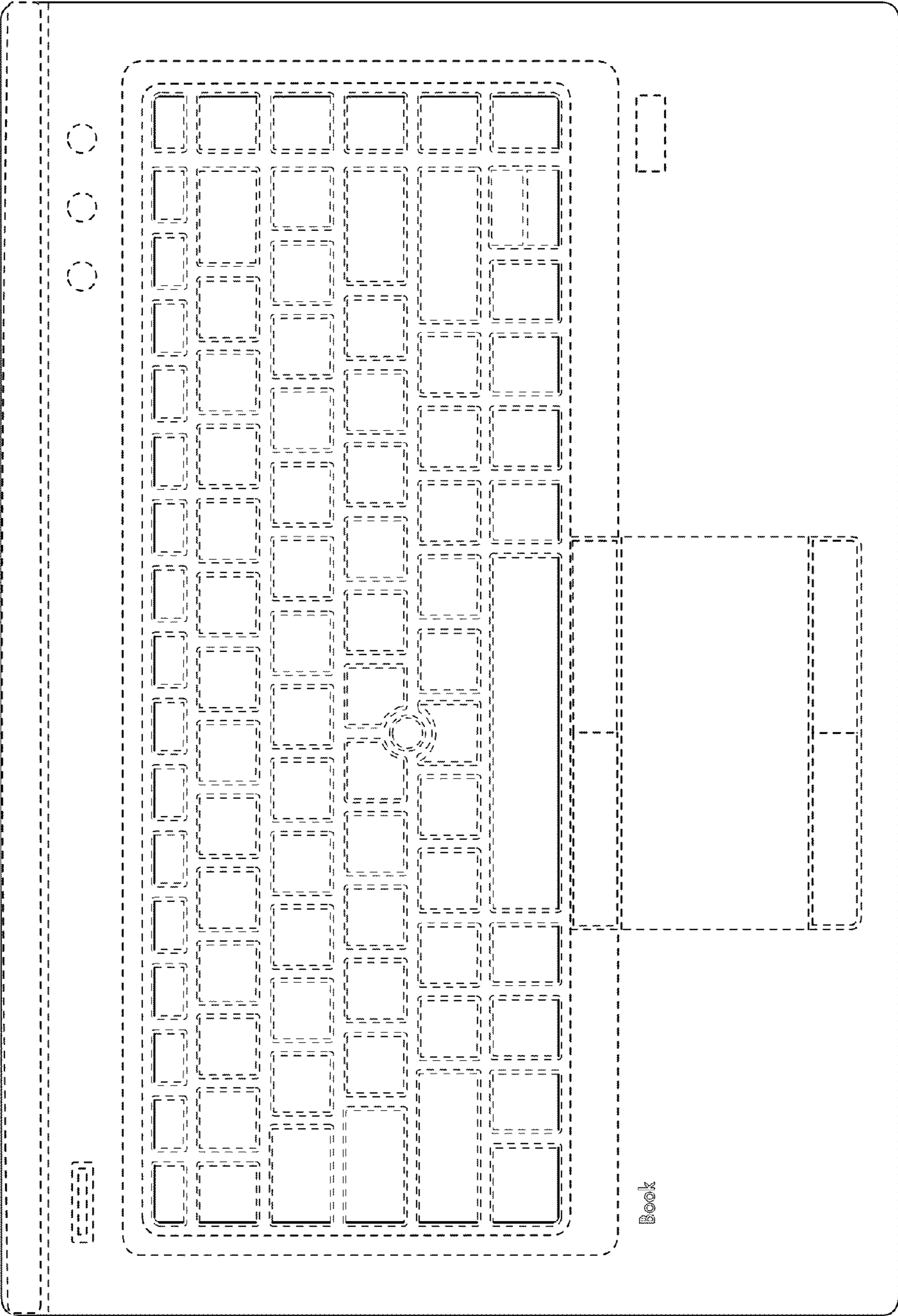

FIG. 8