



US00D678234S

(12) **United States Design Patent**
Chung

(10) **Patent No.:** **US D678,234 S**

(45) **Date of Patent:** **** Mar. 19, 2013**

(54) **MOBILE COMMUNICATION TERMINAL**

(75) Inventor: **In-Sik Chung**, Seoul (KR)

(73) Assignee: **Samsung Electronics Co., Ltd.**,
Suwon-Si (KR)

(**) Term: **14 Years**

(21) Appl. No.: **29/419,690**

(22) Filed: **May 1, 2012**

(30) **Foreign Application Priority Data**

Dec. 30, 2011 (KR) 30-2011-0056362

(51) **LOC (9) Cl.** **14-03**

(52) **U.S. Cl.** **D14/138 G**

(58) **Field of Classification Search** D14/138 G,
D14/138 AD, 341, 346, 138 R, 138 AA, 138 AC,
D14/138 C, 496, 203.1, 203.4, 203.7, 248,
D14/218; 455/575.1, 556.2, 575.3, 575.4;
D21/517; 379/433.01, 433.04; D10/65,
D10/78, 104; D13/168

See application file for complete search history.

(56) **References Cited**

U.S. PATENT DOCUMENTS

- D584,272 S * 1/2009 Chung et al. D14/138 G
- D602,014 S * 10/2009 Andre et al. D14/341
- D615,945 S * 5/2010 Kim et al. D14/138 G
- D619,555 S * 7/2010 Yang et al. D14/138 G
- D626,937 S * 11/2010 Yeo et al. D14/203.7
- D629,799 S * 12/2010 Andre et al. D14/341
- D639,763 S * 6/2011 Kim et al. D14/138 G
- D642,563 S * 8/2011 Akana et al. D14/341
- D643,827 S * 8/2011 Lee et al. D14/138 G
- D645,013 S * 9/2011 Lee et al. D14/138 AB
- D645,015 S * 9/2011 Lee et al. D14/138 G
- D652,008 S * 1/2012 Kim et al. D14/138 G
- D652,813 S * 1/2012 Song et al. D14/138 G
- D653,645 S * 2/2012 Park D14/138 G
- D654,452 S * 2/2012 Son D14/138 G
- D656,118 S * 3/2012 Kim et al. D14/138 G
- D656,918 S * 4/2012 Kim et al. D14/138 G
- D657,329 S * 4/2012 Son D14/138 G

- D658,617 S * 5/2012 Koh D14/138 AD
- D660,274 S * 5/2012 Lee D14/138 G
- D663,287 S * 7/2012 Kim et al. D14/218
- D663,709 S * 7/2012 Kim et al. D14/138 AD
- D669,054 S * 10/2012 Han D14/138 G
- 2009/0247112 A1* 10/2009 Lundy et al. 455/404.1

FOREIGN PATENT DOCUMENTS

KR 30-2011-0046203 11/2011

OTHER PUBLICATIONS

Samsung M130K Galaxy K telephone, announced Oct. 2010, [online]. [site visited Sep. 26, 2011]. Available from Internet, <URL: http://www.gsmarena.com/samsung_m130k_galaxy_k-3584.php>.*

(Continued)

Primary Examiner — Jeffrey D Asch

(74) *Attorney, Agent, or Firm* — Staas & Halsey LLP

(57) **CLAIM**

The ornamental design for a mobile communication terminal, as shown and described.

DESCRIPTION

FIG. 1 is a front perspective view of a mobile communication terminal;

FIG. 2 is a front view of the mobile communication terminal of FIG. 1;

FIG. 3 is a rear view of the mobile communication terminal of FIG. 1;

FIG. 4 is a left-side view of the mobile communication terminal of FIG. 1;

FIG. 5 is a right-side view of the mobile communication terminal of FIG. 1;

FIG. 6 is a top plan view of the mobile communication terminal of FIG. 1; and,

FIG. 7 is a bottom plan view of the mobile communication terminal of FIG. 1.

The broken lines shown in the figures that are immediately adjacent to the shaded areas and define unshaded regions, represent the bounds of the claim, while all other broken lines, including those beneath the transparent panel on the front, are directed to environment and are for illustrative purposes only; the broken lines form no part of the claimed design.

1 Claim, 7 Drawing Sheets

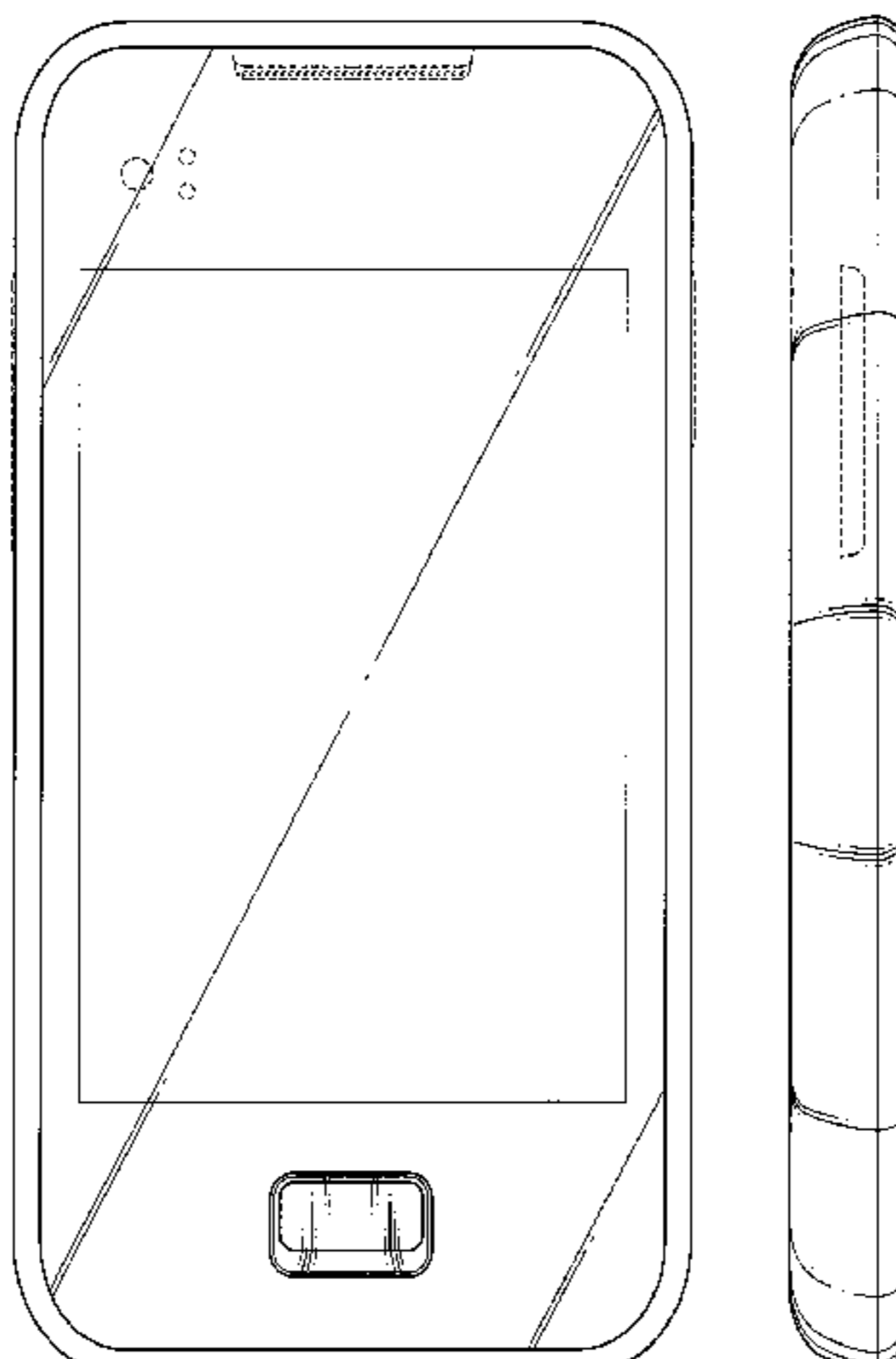

OTHER PUBLICATIONS

Samsung M130L Galaxy U telephone, announced Aug. 2010, [online], [site visited Sep. 26, 2011]. Available from Internet, <URL: http://www.gsmarena.com/samsung_m130l_galaxy_u-3490.php>.*

Samsung S5250 Wave525 telephone, announced Jun. 2010, [online], [site visited Sep. 26, 2011]. Available from Internet, <URL: http://www.gsmarena.com/samsung_s5250_wave525-3400.php>.*

LG Univa E510 telephone, announced Discontinued, [online], [site visited Sep. 26, 2011]. Available from Internet, <URL: http://www.gsmarena.com/lg_univa_e510-4065.php>.*

Samsung Galaxy Ace Plus S7500 telephone, announced Jan. 2012, [online], [site visited Sep. 26, 2011]. Available from Internet, <URL: http://www.gsmarena.com/samsung_galaxy_ace_plus_s7500-4397.php>.*

Samsung Galaxy Ace S5830 telephone, announced Jan. 2011, [online], [site visited Sep. 26, 2011]. Available from Internet, <URL: http://www.gsmarena.com/samsung_galaxy_ace_s5830-3724.php>.*

Samsung Galaxy Ace Duos I589 telephone, announced Feb. 2012, [online], [site visited Sep. 26, 2011]. Available from Internet, <URL: http://www.gsmarena.com/samsung_galaxy_ace_duos_i589-4548.php>.*

Huawei G7300 telephone, announced Nov. 2011, [online], [site visited Sep. 26, 2011]. Available from Internet, <URL: http://www.gsmarena.com/huawei_g7300-4335.php>.*

U.S. Korean Office Action issued on Jul. 2, 2012 in corresponding Korean Design Application No. 30-2011-0056362.

* cited by examiner

FIG. 1

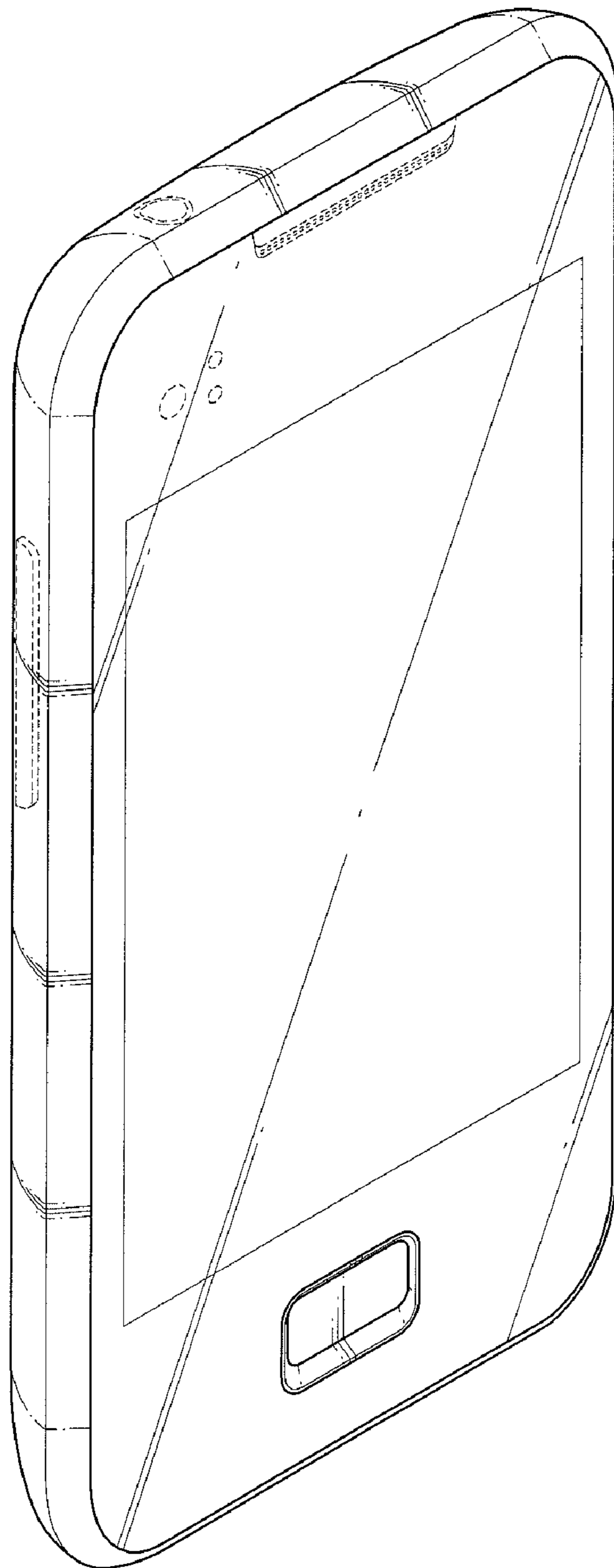

FIG. 2

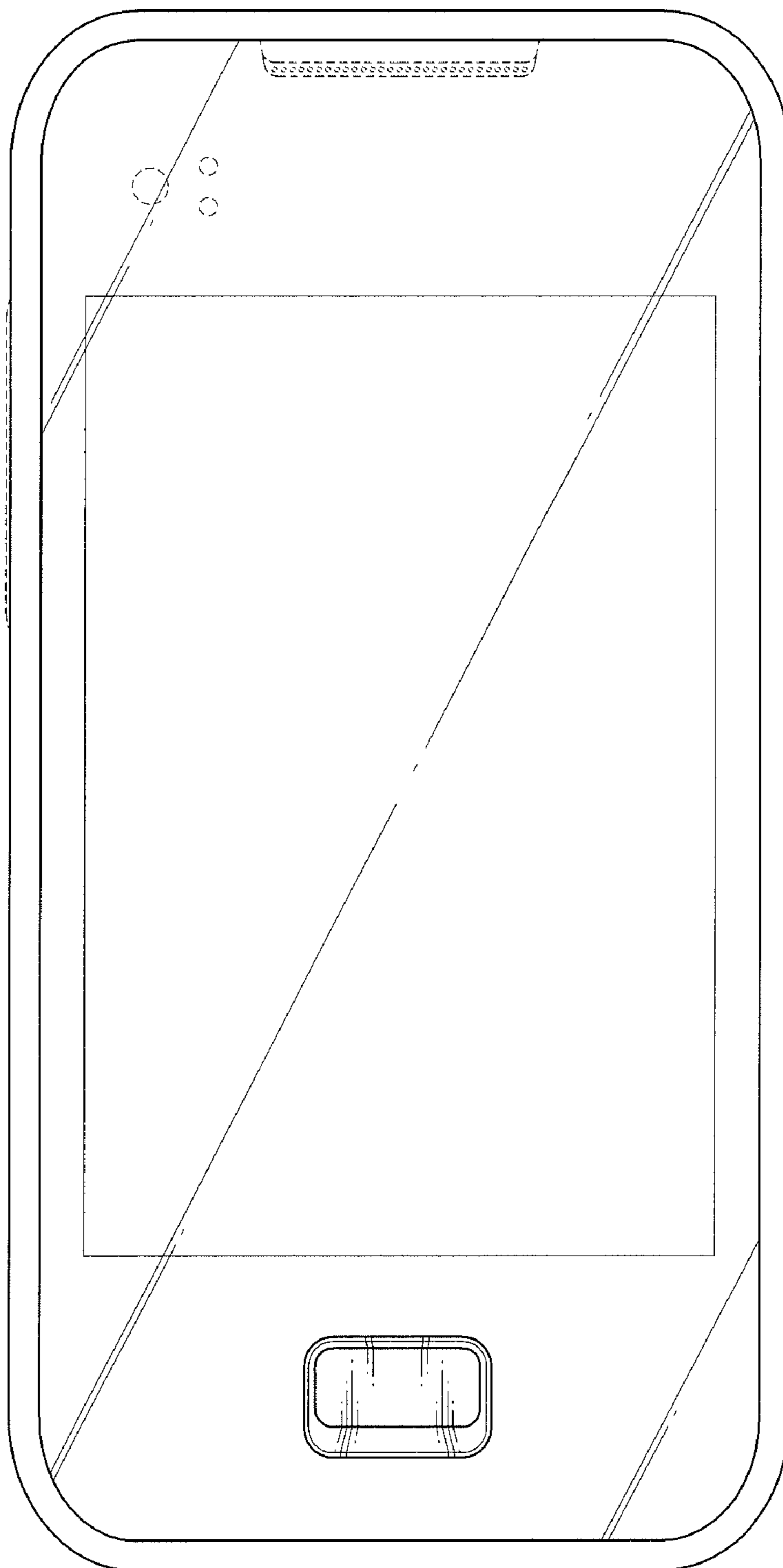

FIG. 3

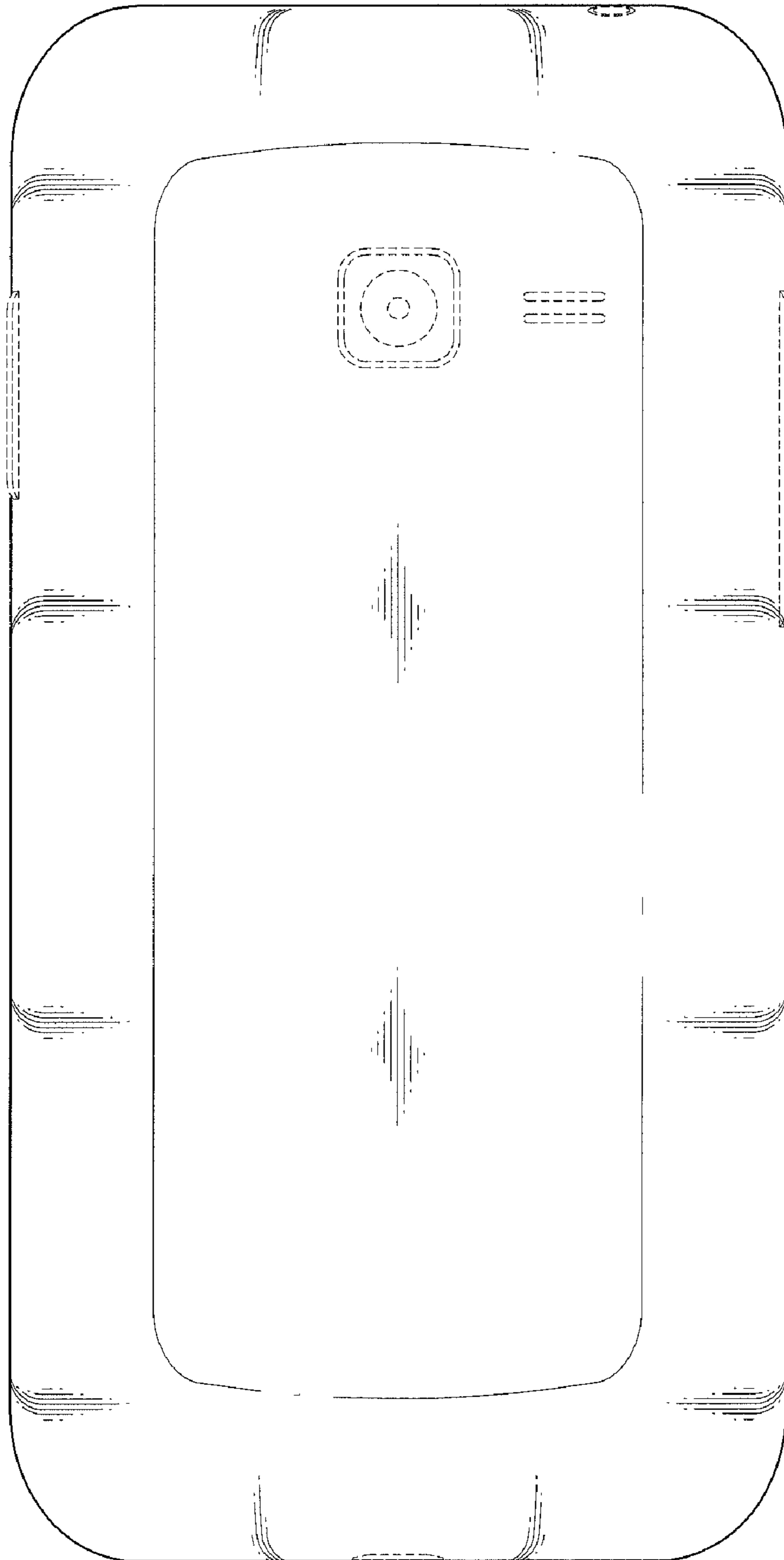

FIG. 4

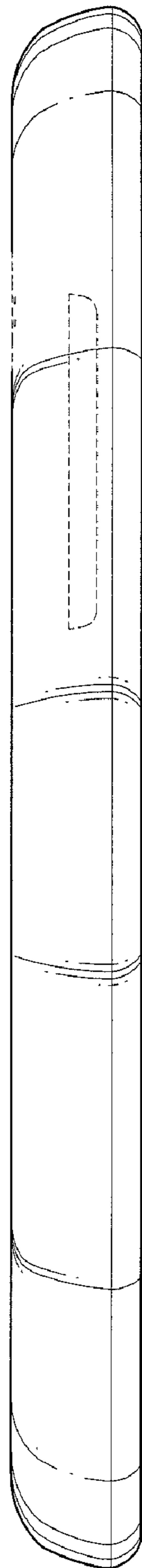

FIG. 5

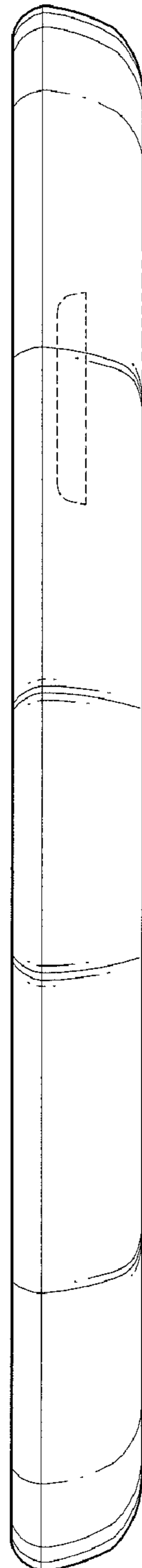

FIG. 6

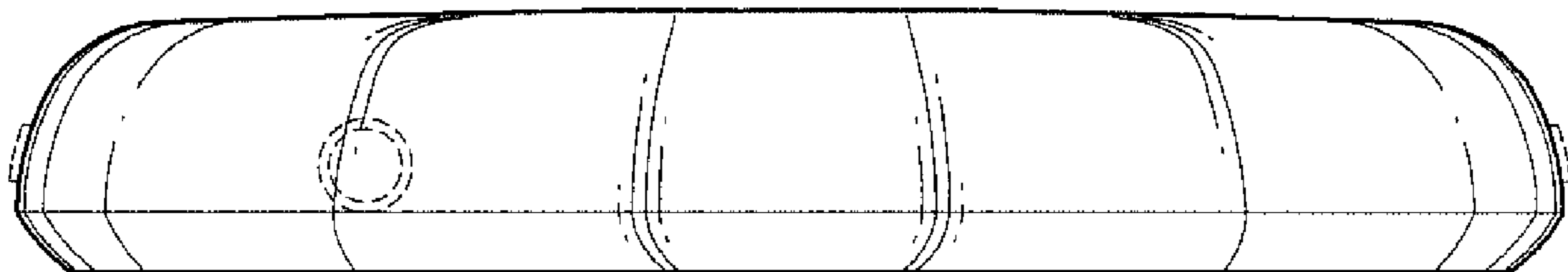

FIG. 7

