



US00D678218S

(12) **United States Design Patent**
Sheen

(10) **Patent No.:** **US D678,218 S**
(45) **Date of Patent:** **** Mar. 19, 2013**

(54) **ELECTRONIC CONTROLLER**
(75) Inventor: **Spencer Sheen**, London (GB)
(73) Assignee: **Warmup PLC**, London (GB)
(**) Term: **14 Years**
(21) Appl. No.: **29/371,449**
(22) Filed: **Mar. 2, 2011**

7,302,642	B2 *	11/2007	Smith et al.	715/702
D556,608	S *	12/2007	Rhodes et al.	D10/50
D582,800	S *	12/2008	Comerford et al.	D10/50
D582,801	S *	12/2008	Comerford et al.	D10/50
D611,500	S *	3/2010	Byle et al.	D14/496
D626,111	S *	10/2010	Jun	D14/203.7
D636,769	S *	4/2011	Wood et al.	D14/341
D648,642	S *	11/2011	Wallaert et al.	D10/50
D651,530	S *	1/2012	Baumgartner et al.	D10/50
2006/0219799	A1 *	10/2006	Schultz et al.	236/1 C
2007/0029397	A1 *	2/2007	Mueller et al.	236/46 C
2010/0106305	A1 *	4/2010	Pavlak et al.	700/276

* cited by examiner

(30) **Foreign Application Priority Data**

Sep. 2, 2010 (EM) 001233456-001-004

(51) **LOC (9) Cl.** **14-03**
(52) **U.S. Cl.** **D13/168**
(58) **Field of Classification Search** D13/168;
D10/49, 50, 104.1, 106.1; D14/203.7, 341,
D14/496; 165/238; 315/158, 295; 340/4.3,
340/4.42, 12.22, 12.23, 12.24, 12.29, 12.3,
340/13.2, 13.21, 13.24; 341/176; 236/49.3,
236/46 R, 51, 1 C, 94; 348/734; 455/352;
700/17, 65, 83, 86, 276, 277
See application file for complete search history.

Primary Examiner — Selina Sikder

(74) *Attorney, Agent, or Firm* — Bacon & Thomas, PLLC

(57) **CLAIM**

The ornamental design for an electronic controller, as shown and described.

DESCRIPTION

FIG. 1 is left side perspective view of my design for an electronic controller;
FIG. 2 is left upper side perspective view thereof;
FIG. 3 is a front elevation view thereof;
FIG. 4 is a top plan view thereof;
FIG. 5 is a left side view thereof;
FIG. 6 is a right side view thereof; and,
FIG. 7 is a bottom view thereof.

(56) **References Cited**

U.S. PATENT DOCUMENTS

D527,658 S * 9/2006 Moore D10/50
7,156,318 B1 * 1/2007 Rosen 236/94

1 Claim, 3 Drawing Sheets

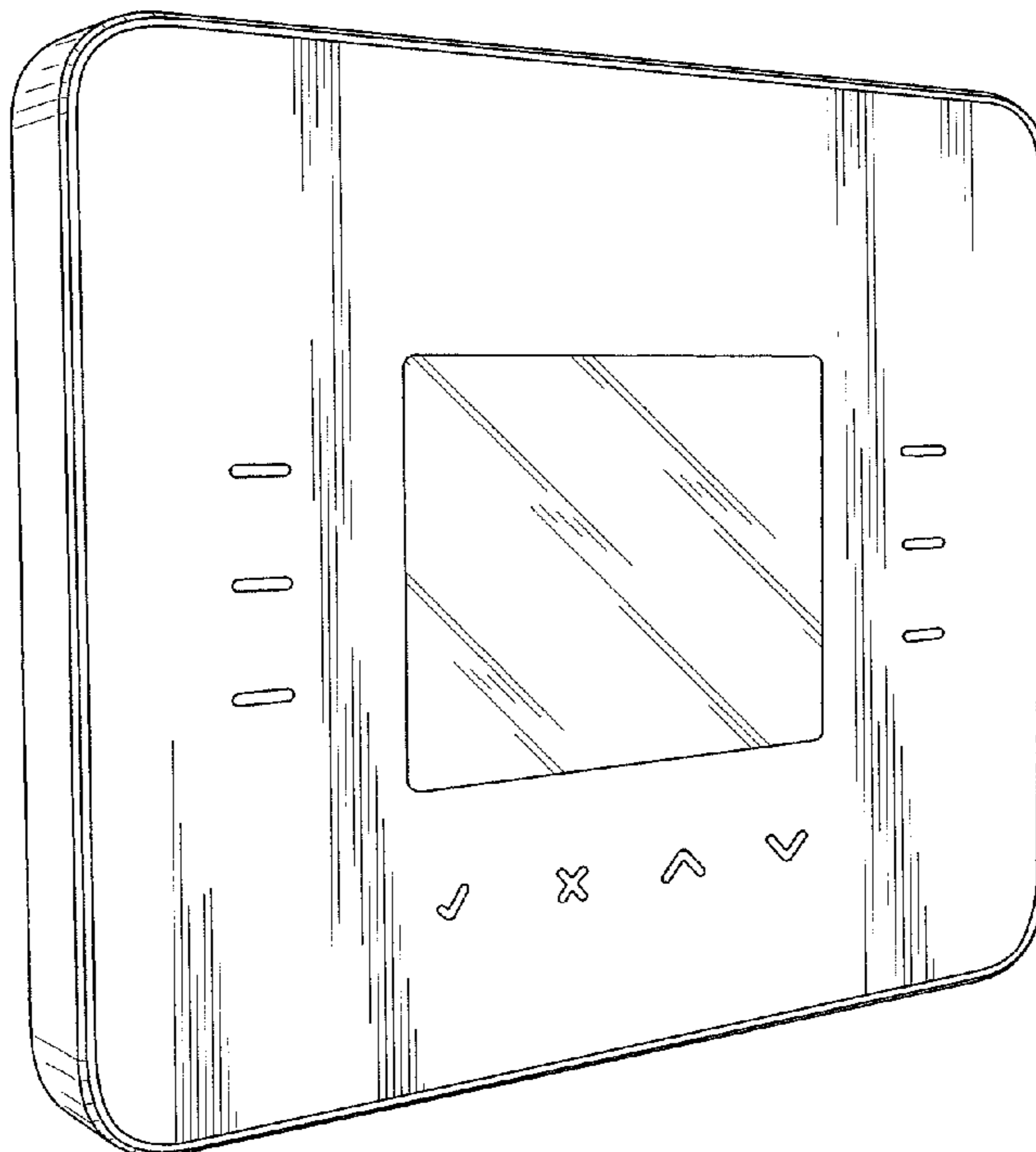

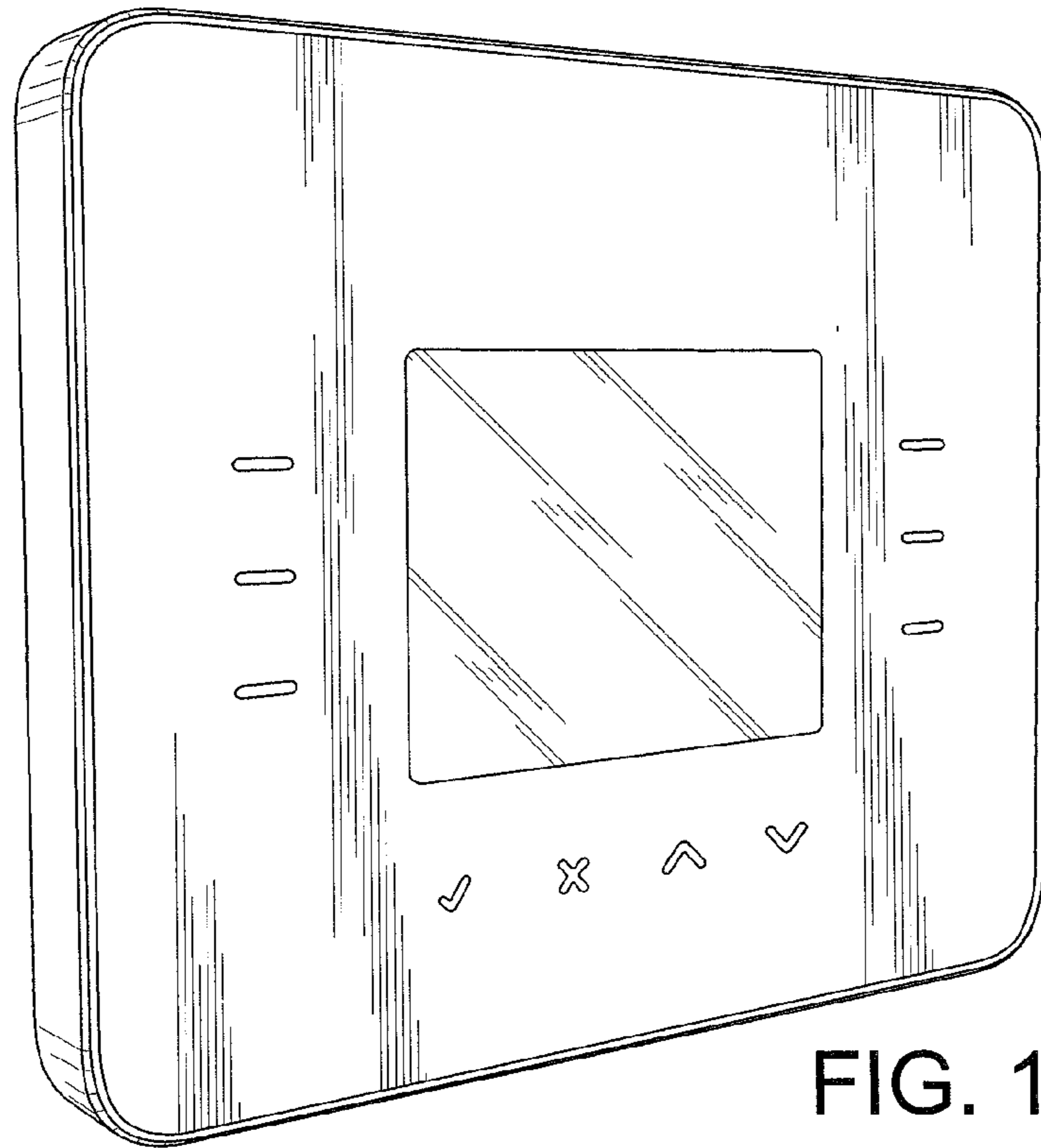

FIG. 1

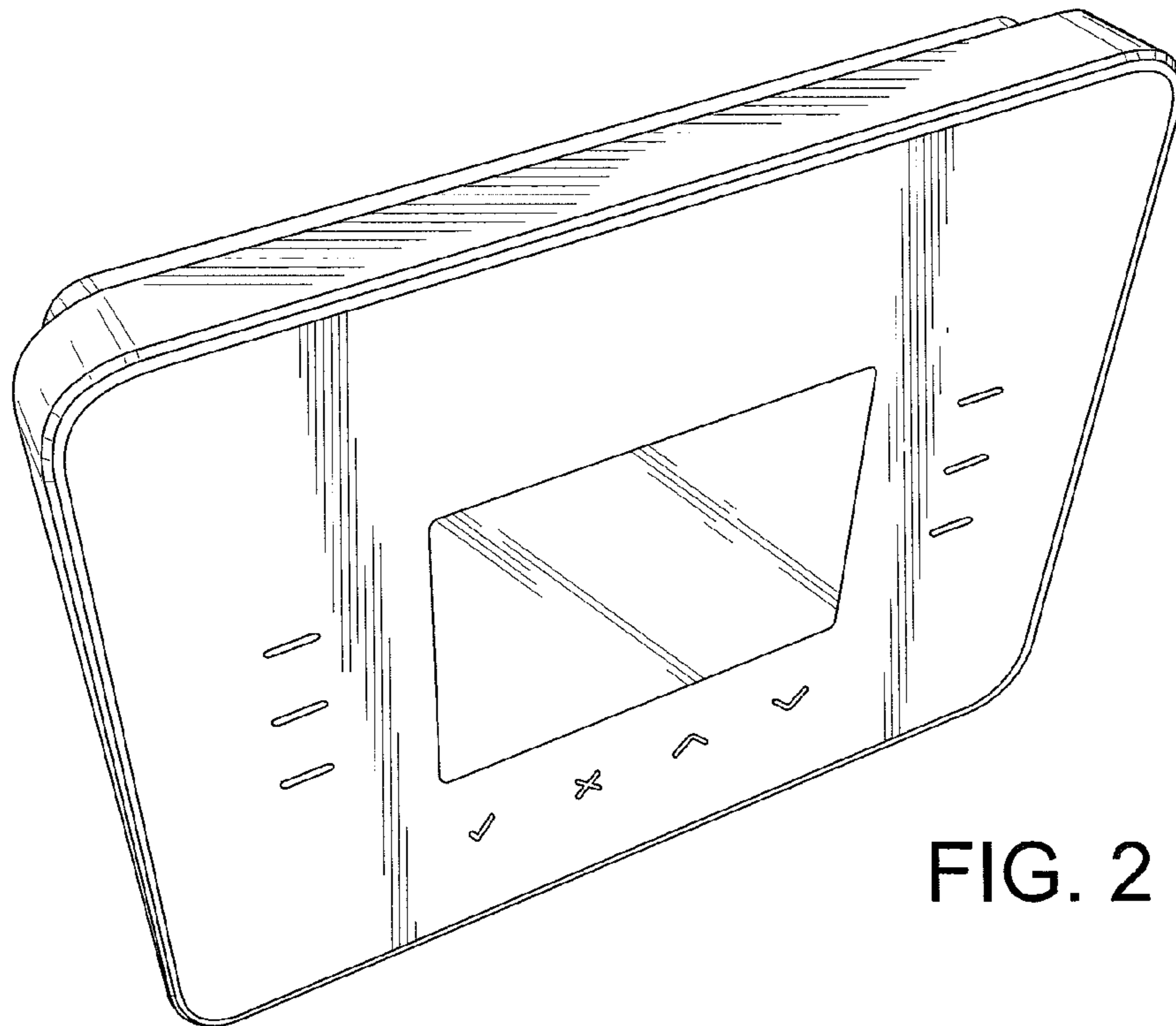

FIG. 2

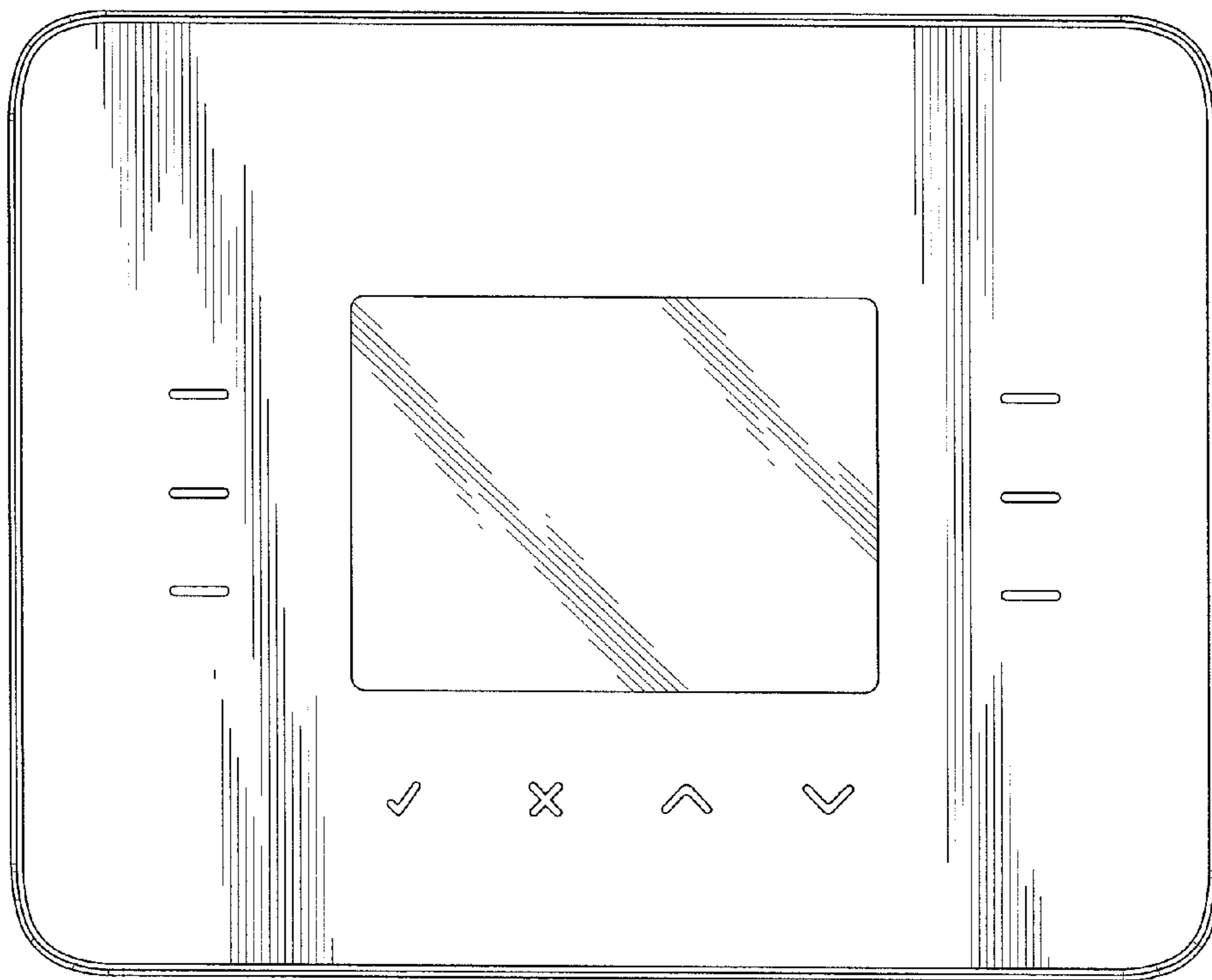

FIG. 3

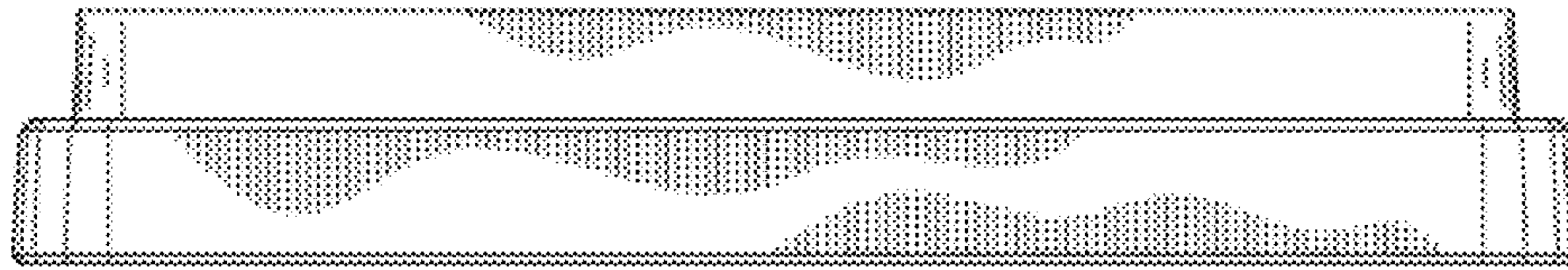

FIG. 4

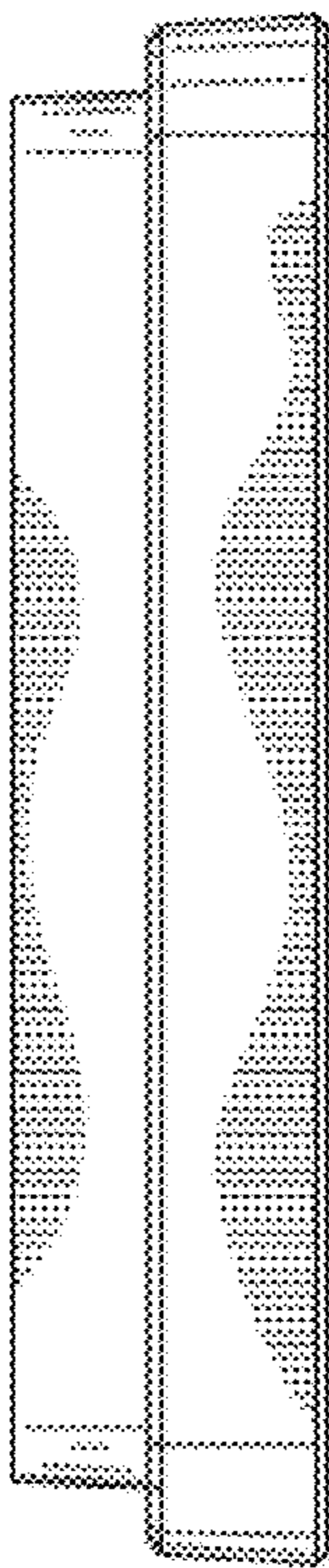

FIG. 5

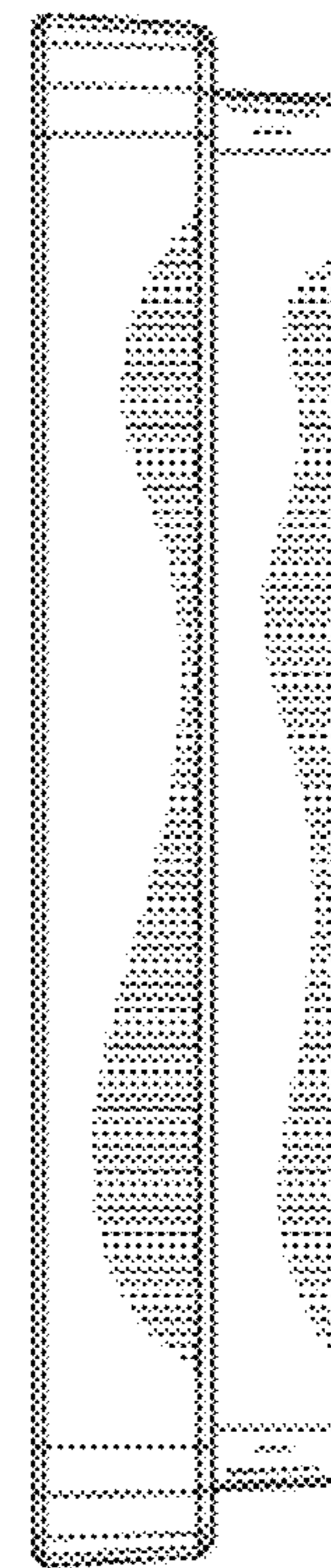

FIG. 6



FIG. 7