



US00D678203S

(12) **United States Design Patent**  
**Corona**

(10) **Patent No.:** **US D678,203 S**  
(45) **Date of Patent:** **\*\* Mar. 19, 2013**

(54) **ELECTRICAL CONNECTOR**

(75) Inventor: **Sergio Corona**, Upland, CA (US)

(73) Assignee: **DSM&T Company, Inc.**, Fontana, CA (US)

(\*\*) Term: **14 Years**

(21) Appl. No.: **29/411,244**

(22) Filed: **Jan. 18, 2012**

(51) **LOC (9) Cl.** ..... **13-03**

(52) **U.S. Cl.** ..... **D13/133**

(58) **Field of Classification Search** ..... D13/133,  
D13/149, 151, 153, 154, 156, 199; 439/79,  
439/248, 258, 274, 35, 352, 353, 358, 359,  
439/362, 378, 445, 447, 57, 8, 584, 585,  
439/656, 66, 676, 677, 678, 679, 68, 681,  
439/682, 686

See application file for complete search history.

(56) **References Cited**

**U.S. PATENT DOCUMENTS**

5,401,181	A	3/1995	Wilson
D360,871	S	8/1995	Wilson
D360,872	S	8/1995	Wilson
D437,828	S	2/2001	Corona
D439,221	S	3/2001	Corona
D445,763	S	7/2001	Corona
D446,186	S	8/2001	Corona
6,379,169	B1	4/2002	Corona
6,383,003	B1	5/2002	Corona

D514,070	S	*	1/2006	Bachmann	.....	D13/149
D521,933	S	*	5/2006	Wade et al.	.....	D13/147
D524,736	S	*	7/2006	Morita et al.	.....	D13/133
D555,594	S	*	11/2007	So	.....	D13/133
7,390,210	B2		6/2008	Corona		
D586,750	S	*	2/2009	Li	.....	D13/133
D596,125	S	*	7/2009	Norin et al.	.....	D13/133
D604,697	S	*	11/2009	Sogo et al.	.....	D13/133
D606,944	S	*	12/2009	Mehnert et al.	.....	D13/154
D613,246	S	*	4/2010	Muecke et al.	.....	D13/133
D616,821	S	*	6/2010	The	.....	D13/133
7,785,123	B2		8/2010	Corona		
D651,171	S	*	12/2011	Yamauchi et al.	.....	D13/133

\* cited by examiner

*Primary Examiner* — Thomas Johannes

(74) *Attorney, Agent, or Firm* — Keusey & Associates, P.C.

(57) **CLAIM**

I claim the ornamental design for an electrical connector, as shown and described.

**DESCRIPTION**

FIG. 1 is a front, top, left side perspective view of my new design for an electrical connector;

FIG. 2 is a top plan view thereof, the bottom plan view being a mirror image thereof;

FIG. 3 is a front side elevation view thereof;

FIG. 4 is a back side elevation view thereof;

FIG. 5 is a right side elevation view thereof; and,

FIG. 6 is a left side elevation view thereof.

The broken lines are included to show unclaimed environment structure and form no part of the claimed design.

**1 Claim, 2 Drawing Sheets**

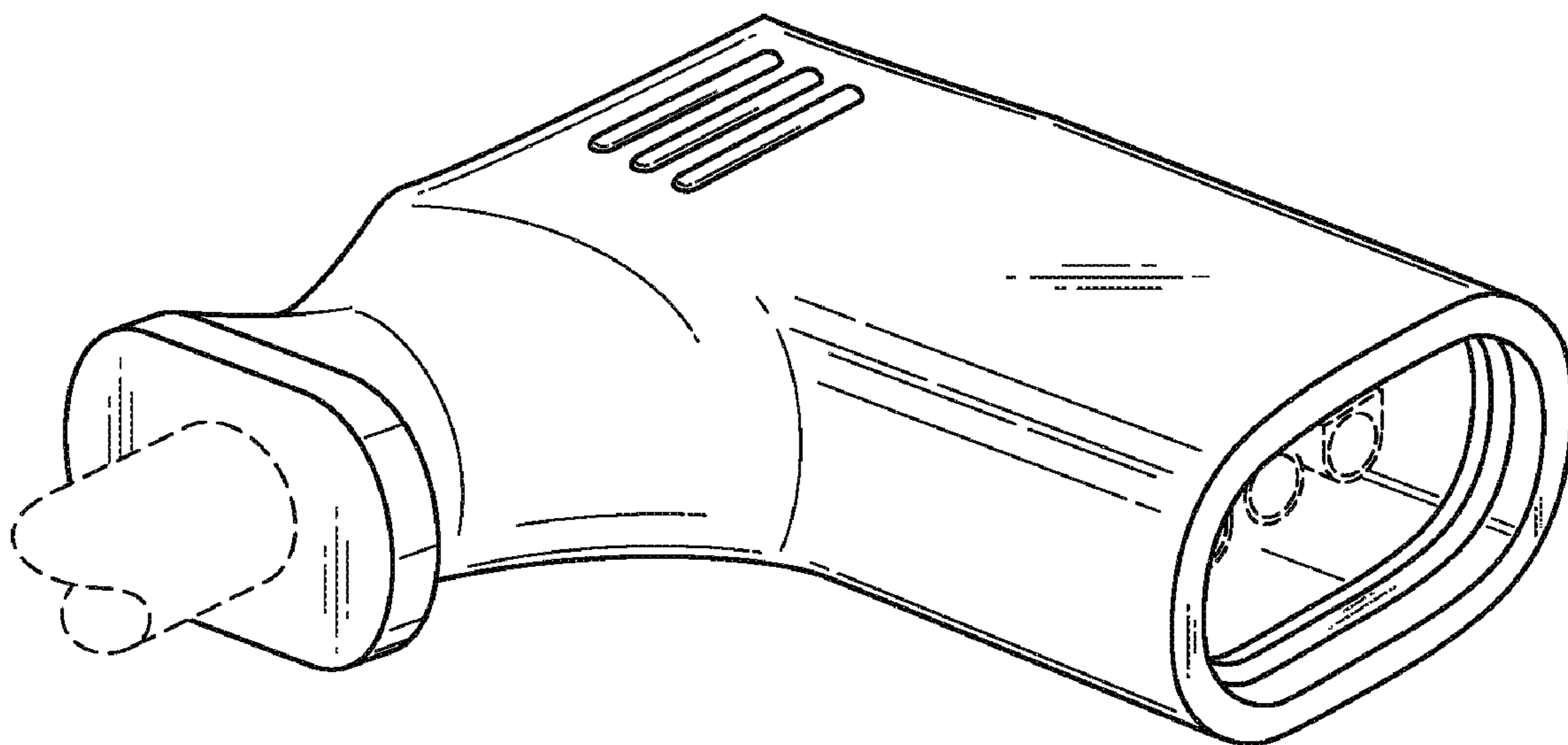

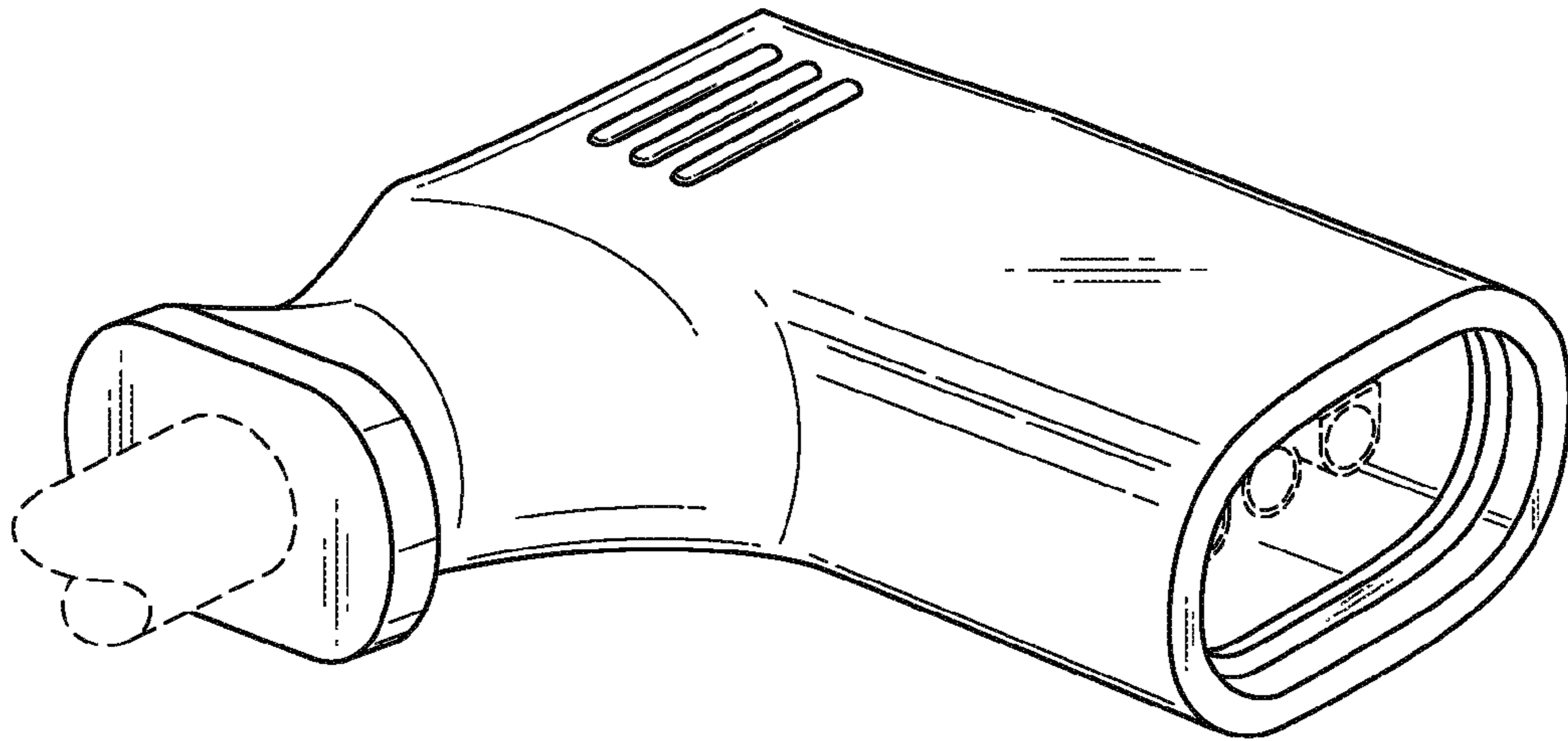

FIG. 1

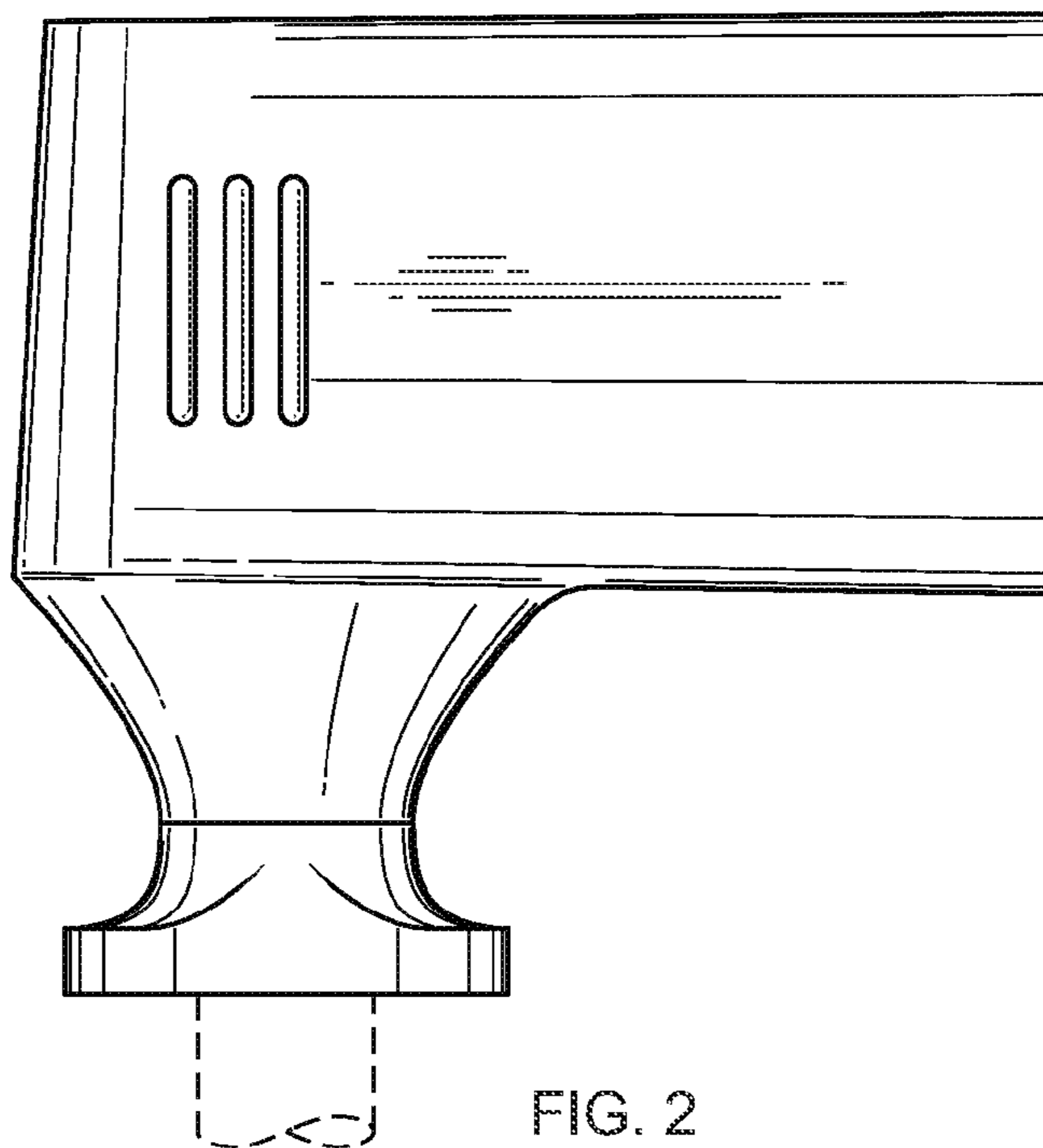

FIG. 2

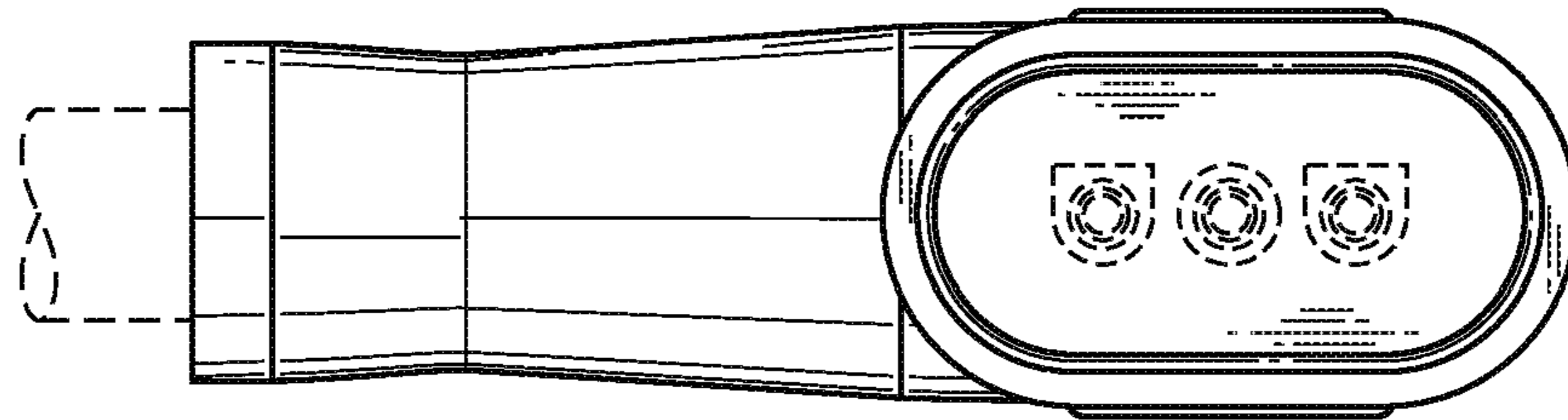

FIG. 3

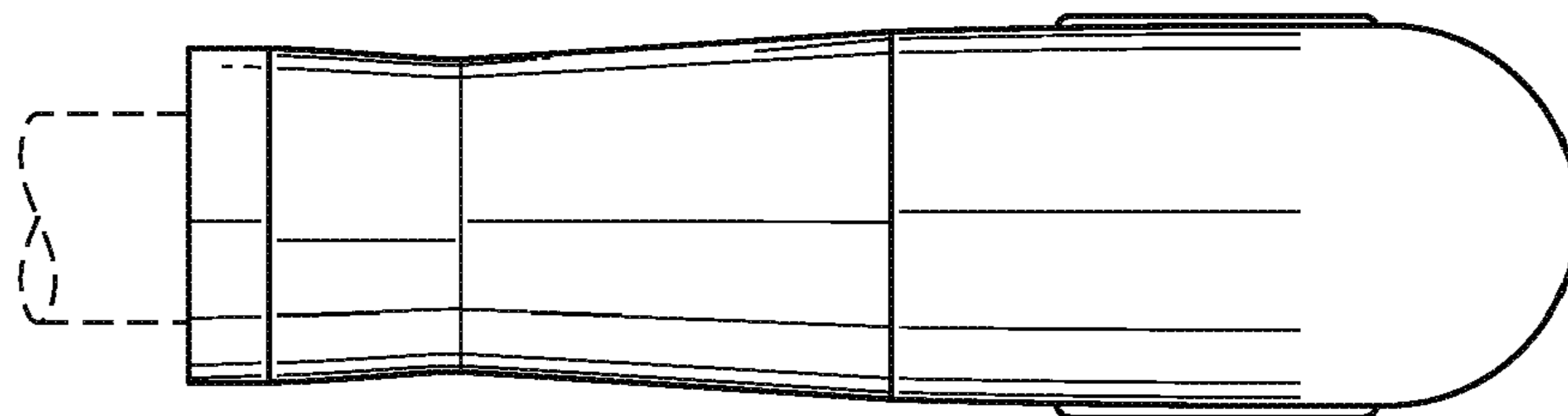

FIG. 4

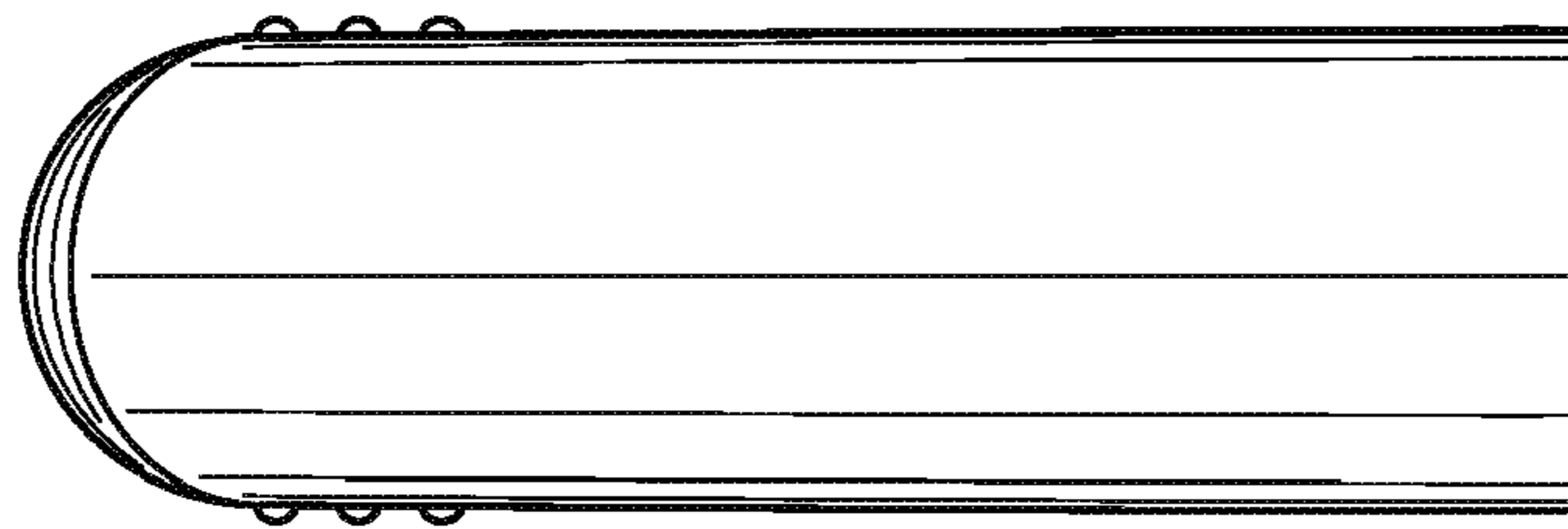

FIG. 5

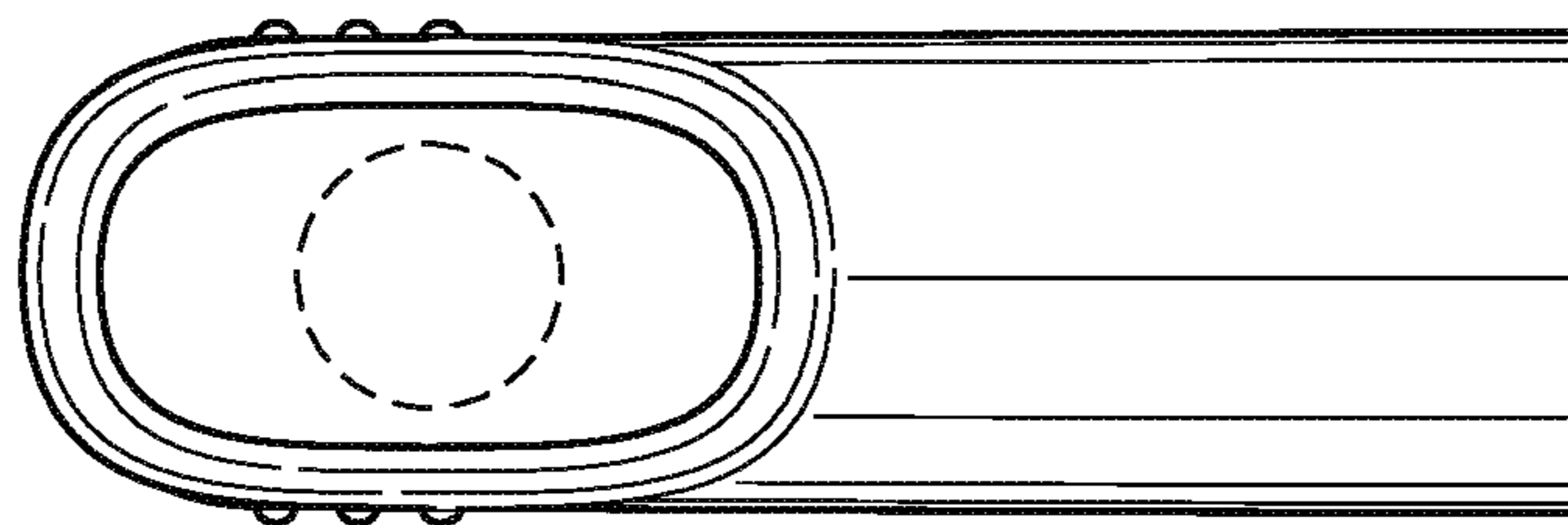

FIG. 6