



US00D678070S

(12) **United States Design Patent**
Meeks

(10) **Patent No.:** **US D678,070 S**
(45) **Date of Patent:** **** Mar. 19, 2013**

(54) **BOTTLE**

(75) Inventor: **Alan Michael George Meeks,**
Chichester (GB)

(73) Assignee: **Pure Hold Limited,** Southampton (GB)

(**) Term: **14 Years**

(21) Appl. No.: **29/404,062**

(22) Filed: **Oct. 14, 2011**

(30) **Foreign Application Priority Data**

Apr. 15, 2011 (EM) 001271860-0001

(51) **LOC (9) Cl.** **09-01**

(52) **U.S. Cl.** **D9/521; D9/543; D9/571; D9/575**

(58) **Field of Classification Search** D9/682,
D9/685, 693-694, 516, 521-523, 530, 543-546,
D9/560, 562, 571-575; D7/612-615, 629;
215/379, 381-384, 396, 398; D24/121, 216,
D24/224; D23/225; D30/121; D6/545

See application file for complete search history.

(56) **References Cited**

U.S. PATENT DOCUMENTS

D208,011 S * 6/1967 Swayze D9/523
D275,650 S * 9/1984 Guiguizian D9/741
D284,835 S * 7/1986 Banks D9/572
4,710,634 A 12/1987 Brookes
D294,581 S * 3/1988 Storlie D15/5
D301,978 S * 7/1989 Saunders et al. D9/523 X
D325,258 S * 4/1992 Andersen et al. D24/224 X
5,152,965 A * 10/1992 Fisk et al. 206/221 X
D331,516 S * 12/1992 Waring D6/545
D332,544 S * 1/1993 Steiner et al. D6/545
D334,795 S * 4/1993 Demarest D23/225
D342,176 S * 12/1993 Steiner et al. D6/545
D353,464 S * 12/1994 Ushikubo D24/224
D376,208 S * 12/1996 Rasmussen et al. D24/224
D384,779 S * 10/1997 Krause D30/121
D404,950 S * 2/1999 Burch D6/545
D406,351 S * 3/1999 Yamazaki et al. D24/224

D407,826 S * 4/1999 Yamazaki et al. D24/224
D414,359 S * 9/1999 Scholey et al. D6/515
D426,162 S * 6/2000 Olson D9/528
6,185,785 B1 2/2001 Kingston
D441,999 S * 5/2001 Kautzlarich et al. D6/545
D451,394 S * 12/2001 Studer D9/521
D462,621 S * 9/2002 DeKoning et al. D9/560
D502,268 S * 2/2005 Sakai et al. D24/224
6,874,697 B2 4/2005 Callueng
D539,653 S * 4/2007 James et al. D9/526
7,320,418 B2 1/2008 Sassoon
7,360,674 B2 4/2008 Sassoon
D609,102 S * 2/2010 Matlin D9/530 X
D611,531 S * 3/2010 Hatasa et al. D18/56
2005/0011042 A1 1/2005 Hupp et al.
2010/0051641 A1 3/2010 Sassoon

FOREIGN PATENT DOCUMENTS

BE 1015999 A3 4/2004
DE 10014472 3/2000
DE 202004006845 4/2004
EP 1164235 6/2001
FR 2780744 7/1998
FR 2824096 4/2001
GB 2387542 4/2002
GB 2382987 6/2003
GB 2418857 10/2004

(Continued)

Primary Examiner — Carol P Rademaker

(74) *Attorney, Agent, or Firm* — Vierra Magen Marcus & DeNiro LLP

(57) **CLAIM**

The ornamental design for a bottle, as shown and described.

DESCRIPTION

FIG. 1 is a perspective view from above;
FIG. 2 is another perspective view from above;
FIG. 3 is a perspective view from below;
FIG. 4 is another perspective view from below;
FIG. 5 is a side view;
FIG. 6 is a front view; and,
FIG. 7 is a bottom plan view.

1 Claim, 7 Drawing Sheets

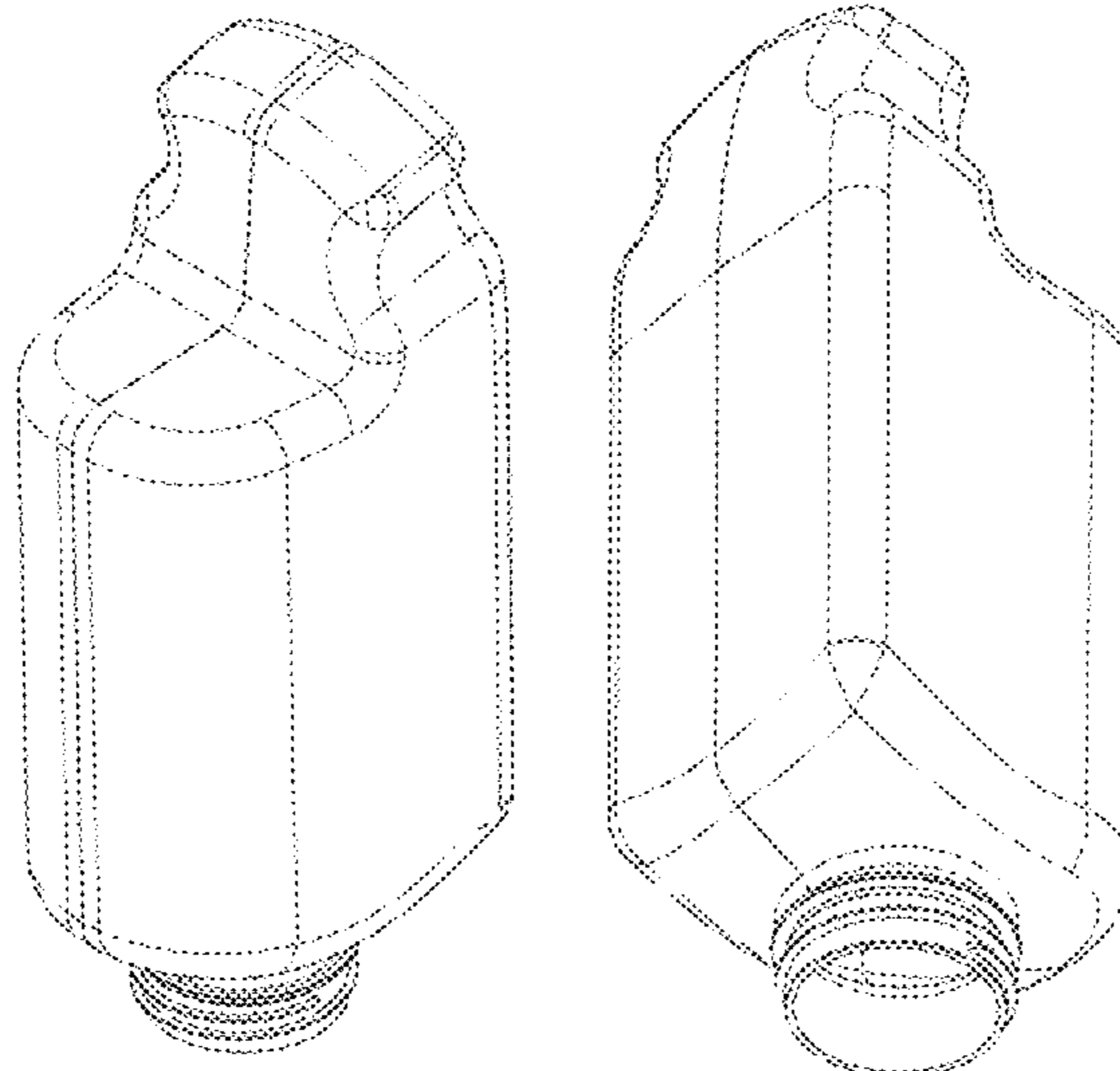

US D678,070 S

Page 2

FOREIGN PATENT DOCUMENTS			WO	WO02/055817	7/2002
GB	2421897	1/2005	WO	WO2005/115356	12/2005
GB	2436284	3/2006	WO	WO2008/035121	3/2008
JP	7327763	6/1994	WO	WO03/050366	5/2008
SU	408636	11/1973	* cited by examiner		

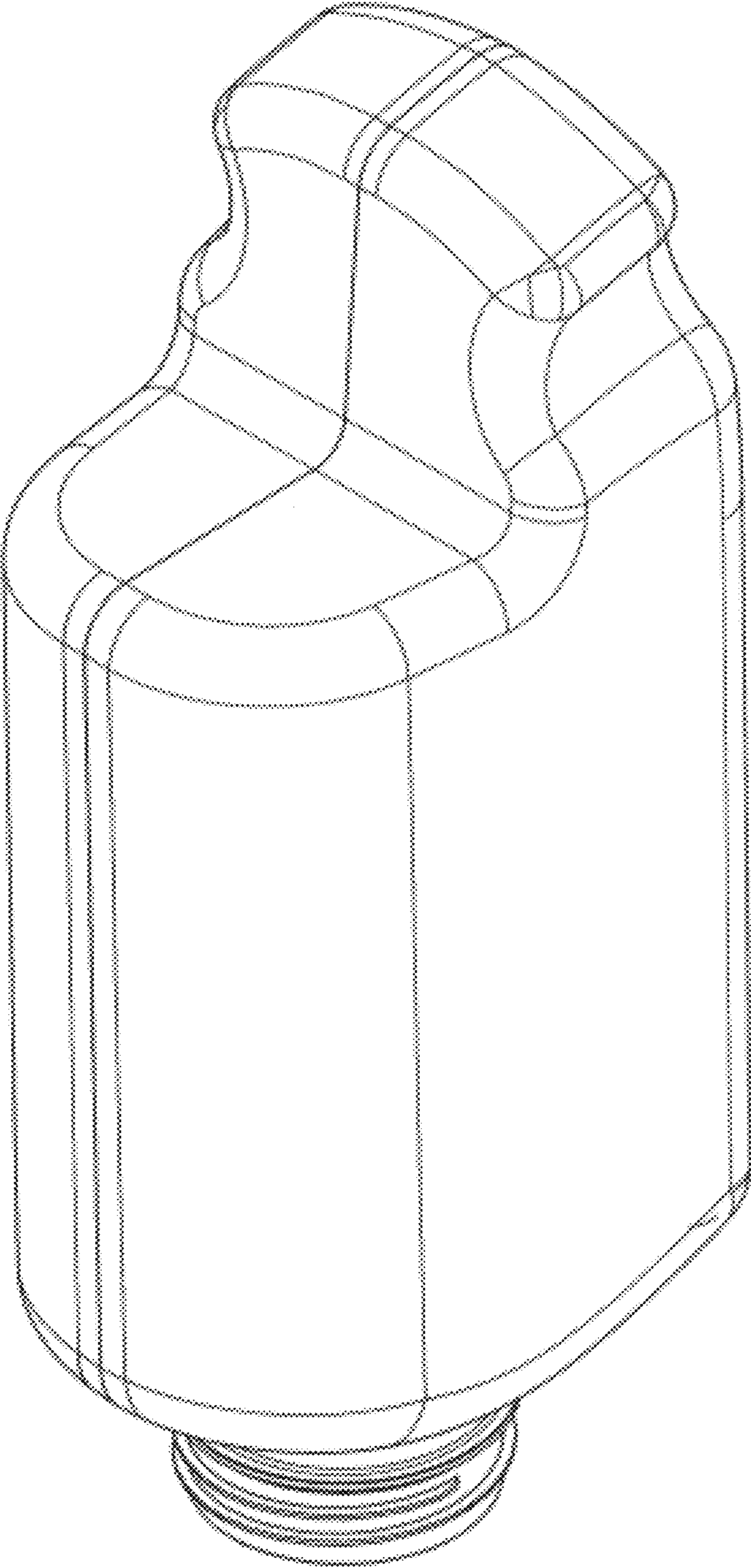

Figure 1

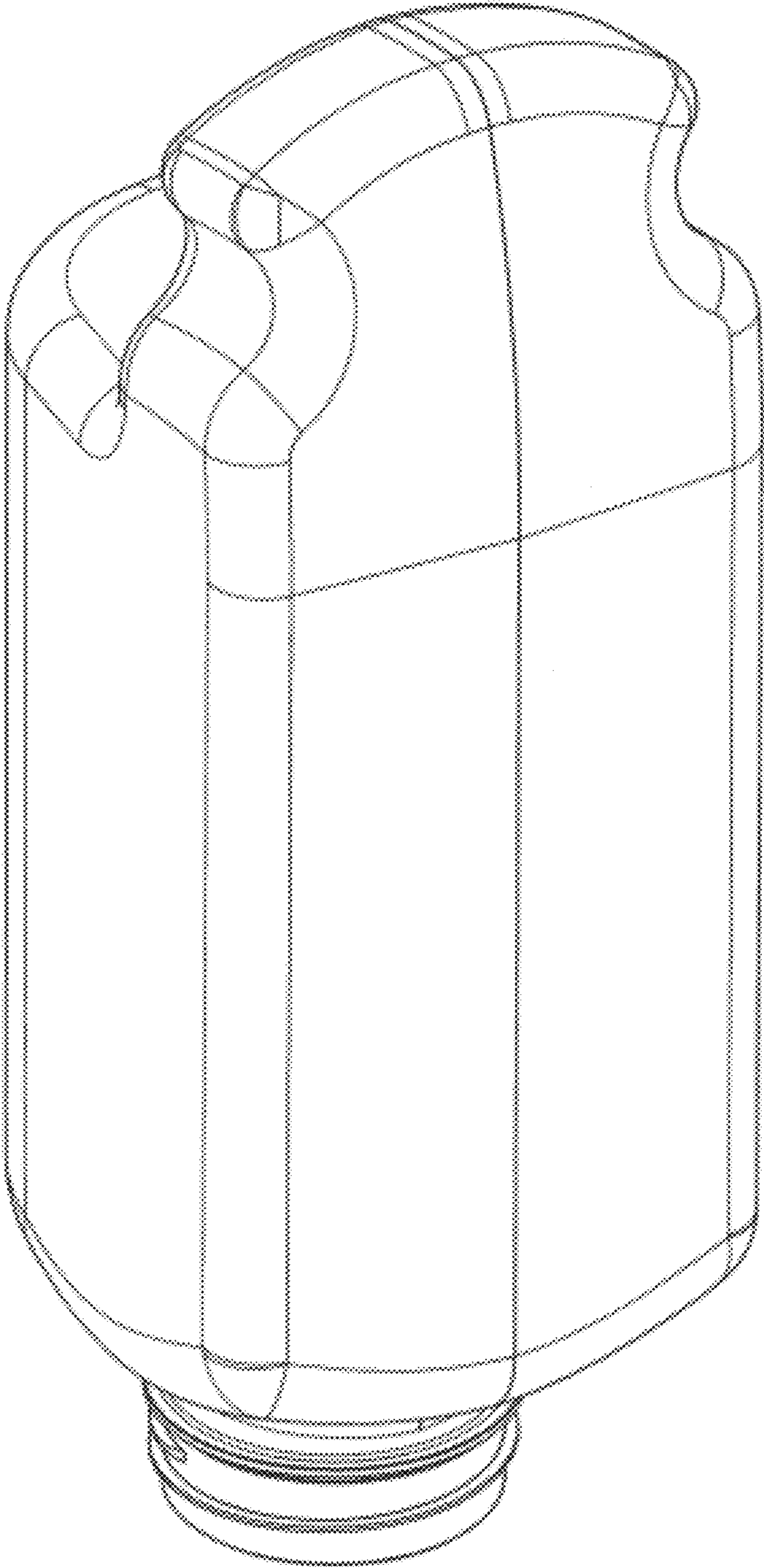

Figure 2

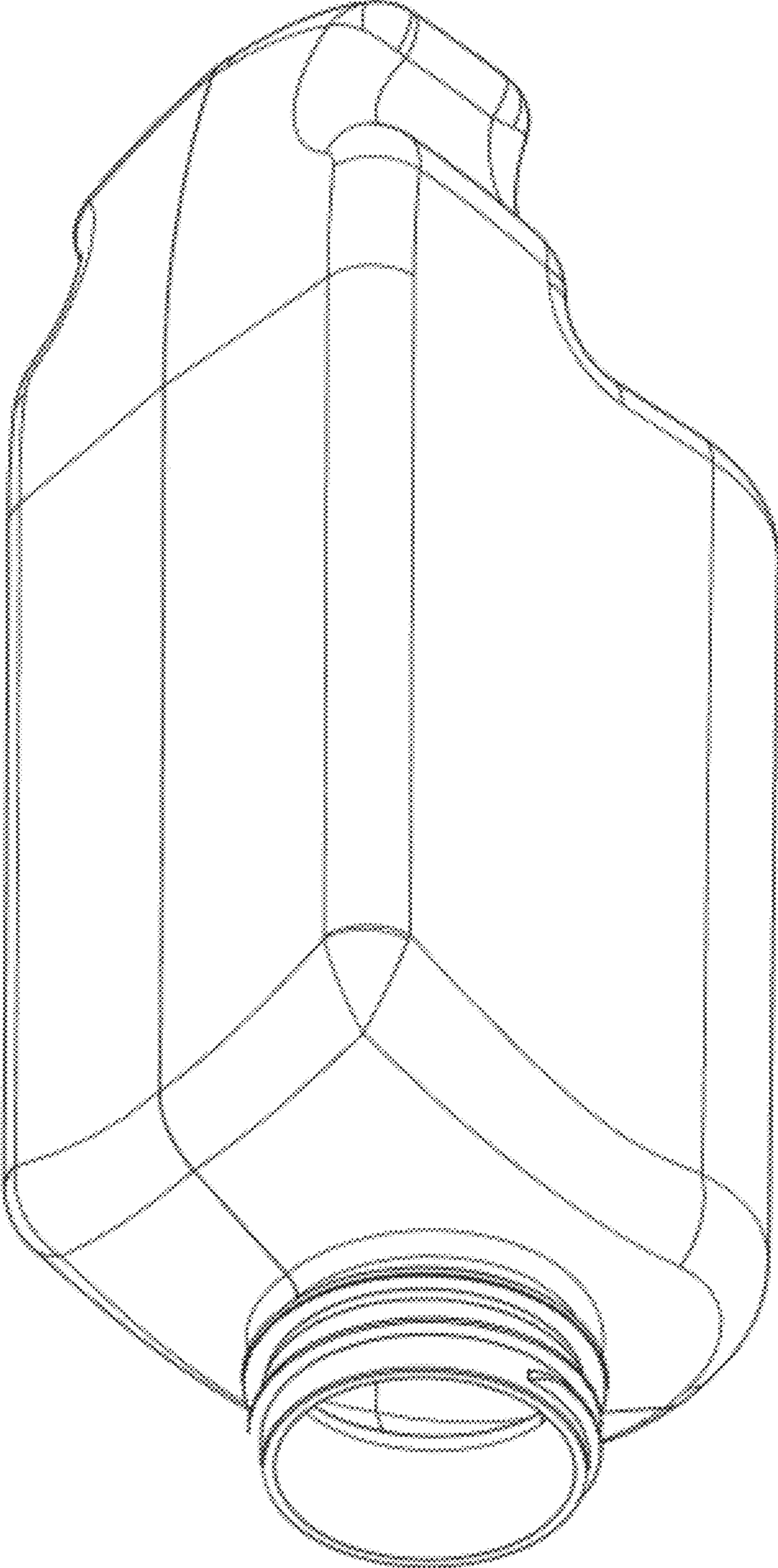

Figure 3

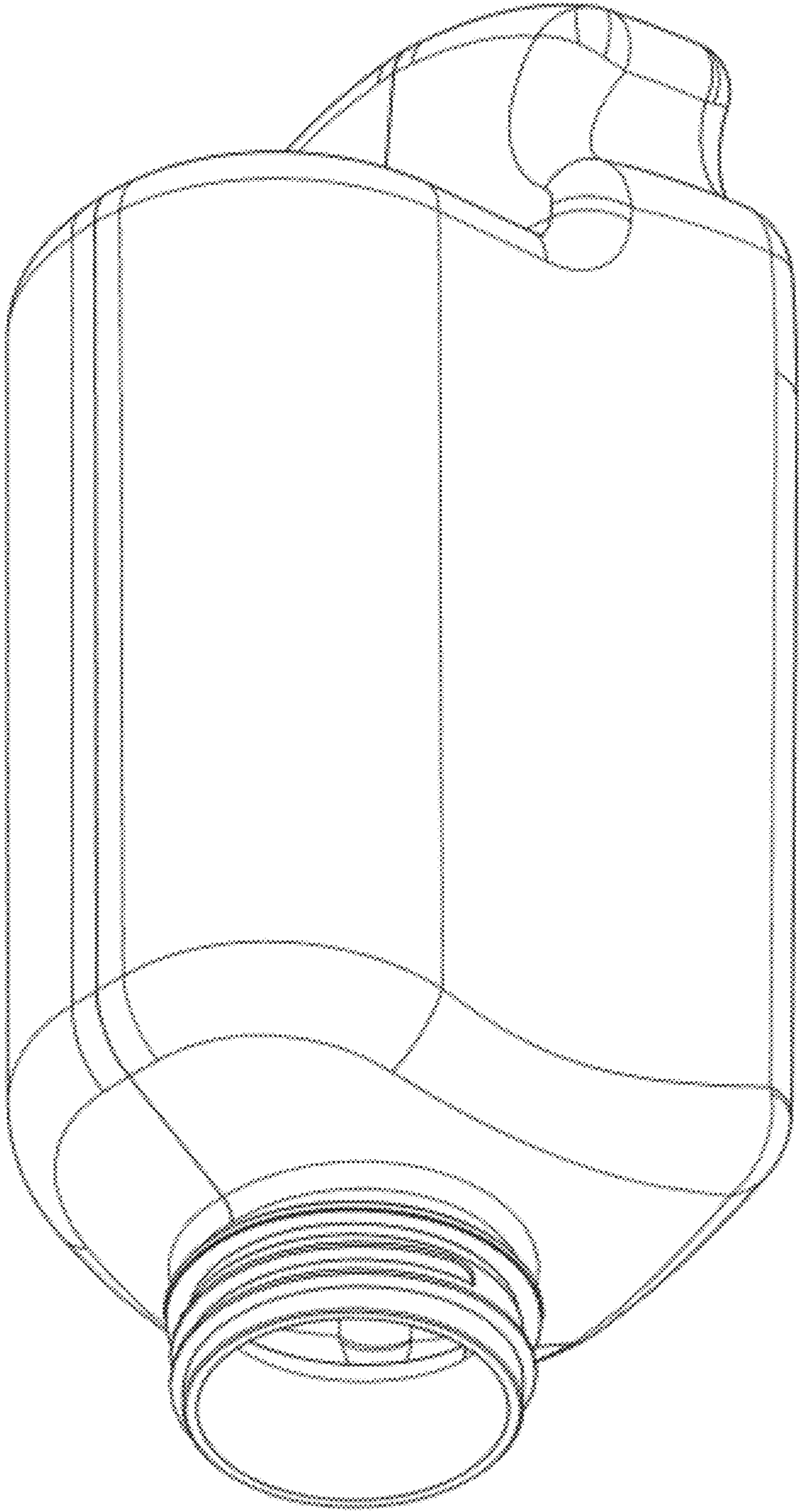

Figure 4

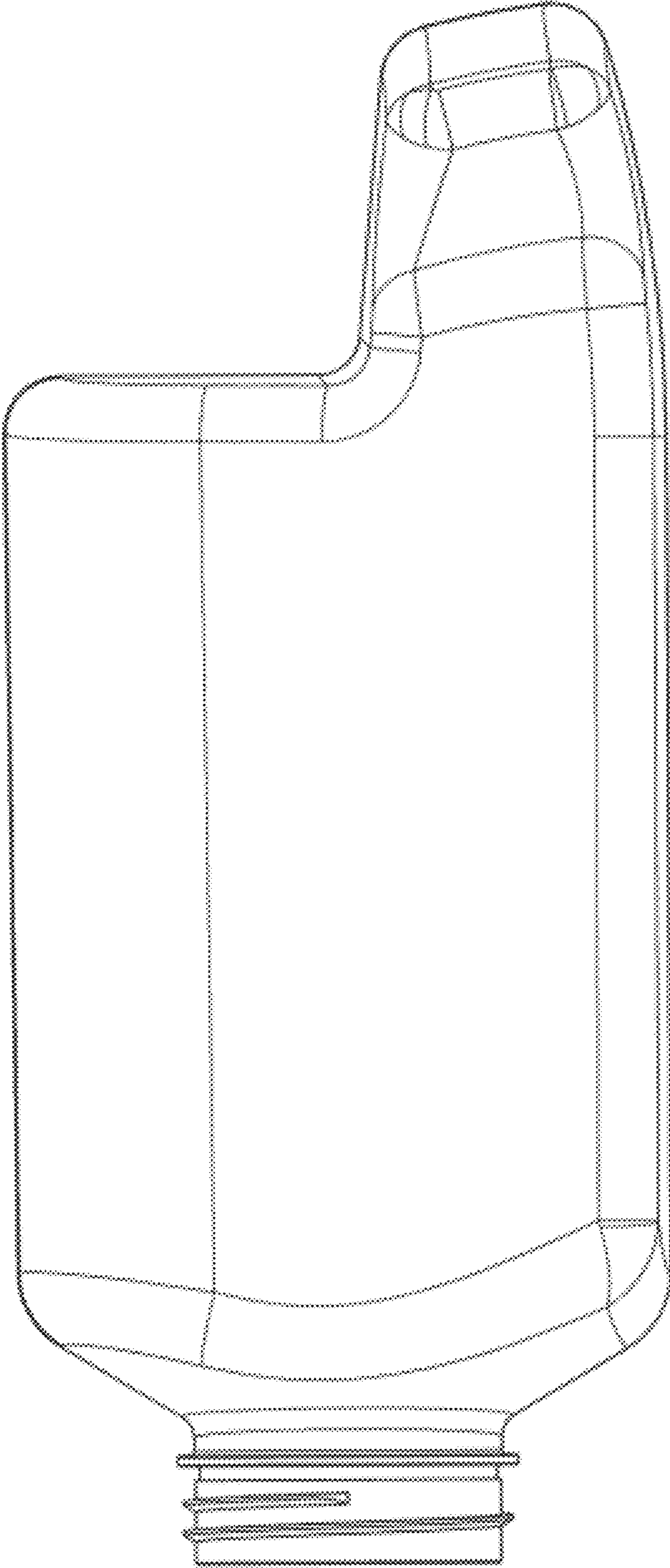

Figure 5

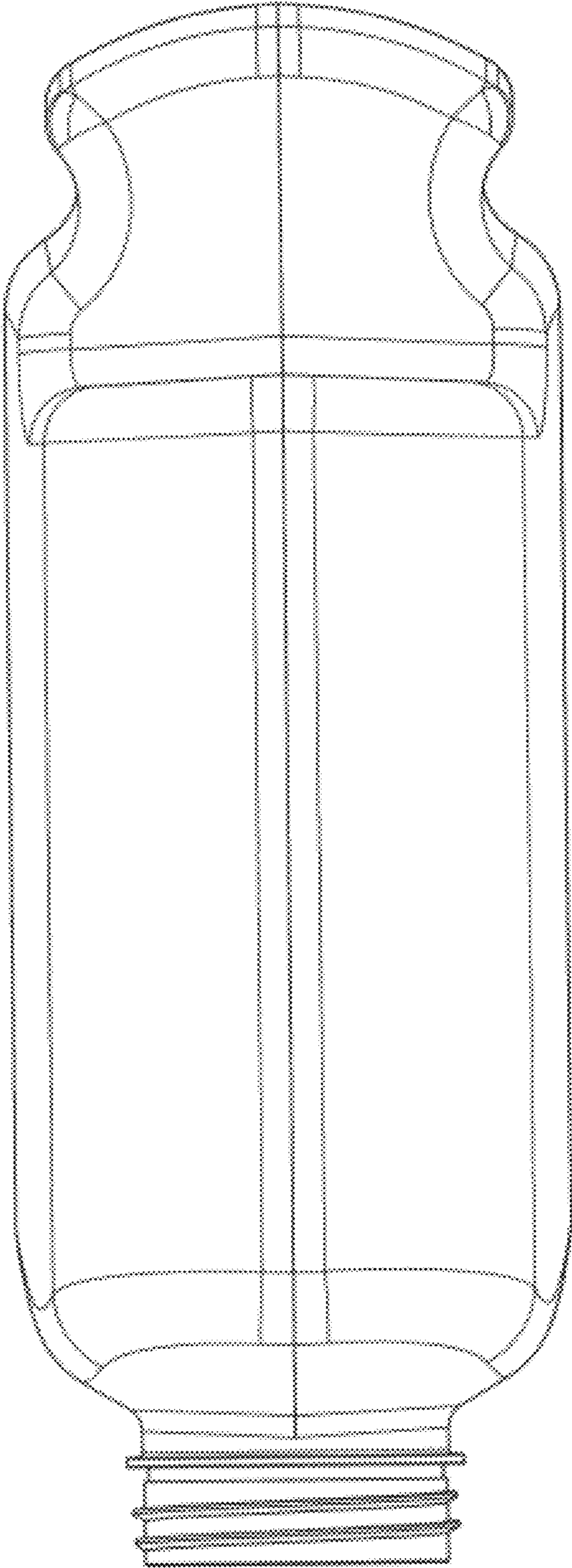

Figure 6

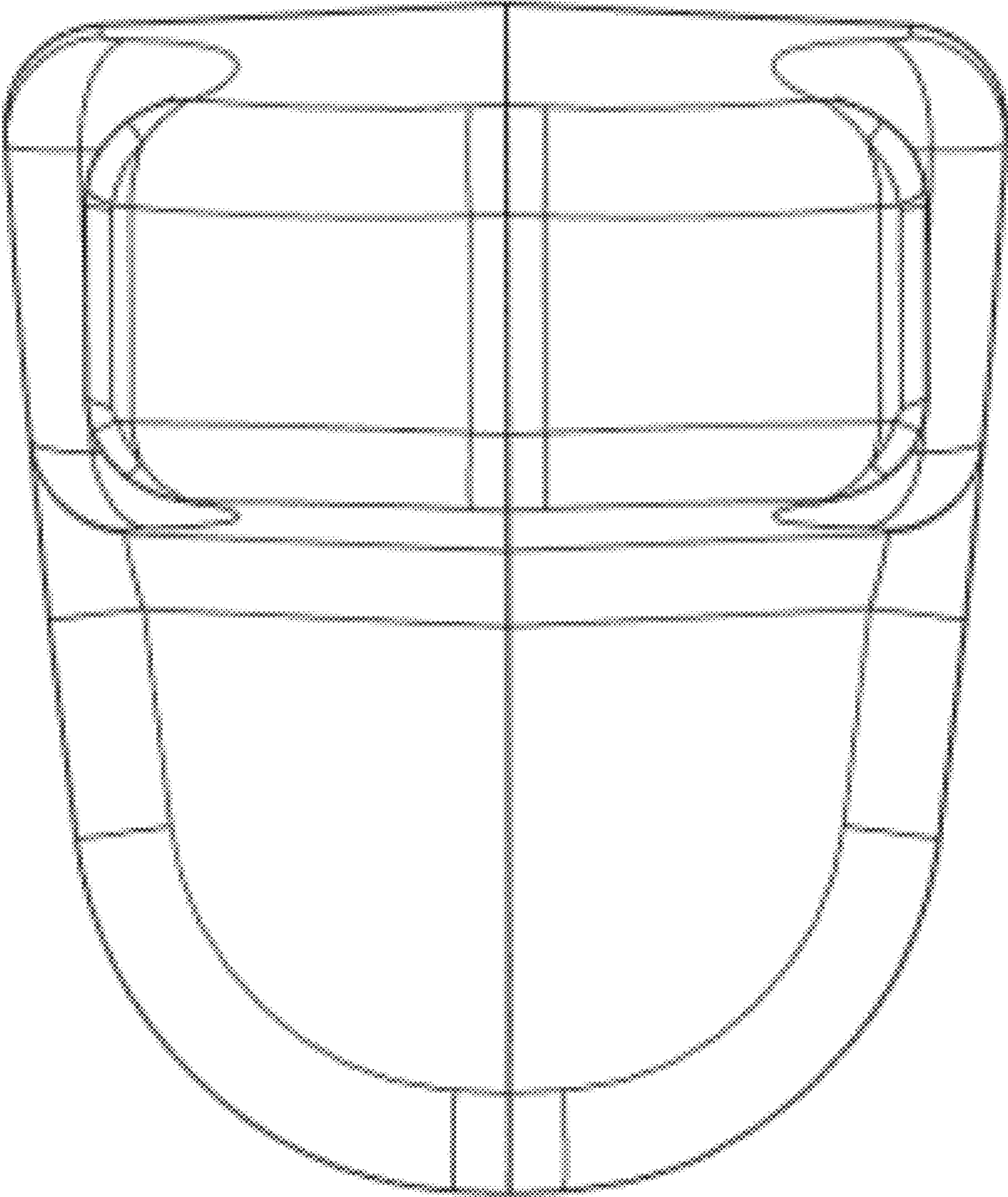

Figure 7