



US00D678042S

(12) **United States Design Patent**
Jacobson

(10) **Patent No.:** **US D678,042 S**
(45) **Date of Patent:** **** Mar. 19, 2013**

(54) **DRAPERY PIN INSTALLER**

(76) Inventor: **Jeff A. Jacobson**, Corona del Mar, CA
(US)

(**) Term: **14 Years**

(21) Appl. No.: **29/368,882**

(22) Filed: **Aug. 31, 2010**

(51) **LOC (9) Cl.** **08-05**

(52) **U.S. Cl.** **D8/369; D8/349**

(58) **Field of Classification Search** D8/369,
D8/367, 354, 349; 221/232

See application file for complete search history.

(56) **References Cited**

U.S. PATENT DOCUMENTS

4,183,447	A	1/1980	Jacobson	
6,595,478	B2 *	7/2003	Lee	248/262
7,100,661	B1 *	9/2006	Pittman	160/38
D534,415	S *	1/2007	Salice	D8/349
7,370,839	B2 *	5/2008	Putman	248/262
D633,373	S *	3/2011	Grenade	D8/381
D654,347	S *	2/2012	Chen	D8/349
D654,349	S *	2/2012	Schopf	D8/354

* cited by examiner

Primary Examiner — Cynthia Underwood

(74) *Attorney, Agent, or Firm* — Greenberg Traurig, LLP

(57) **CLAIM**

I claim the ornamental design for a drapery pin installer, as shown and described.

DESCRIPTION

FIG. 1 is a perspective view of the drapery pin installer showing my new design;
FIG. 2 is a front elevational view of the drapery pin installer showing my new design;
FIG. 3 is a rear elevational view of the drapery pin installer showing my new design;
FIG. 4 is an elevational view of one side of the drapery pin installer showing my new design;
FIG. 5 is an elevational view of the other side of the drapery pin installer showing my new design;
FIG. 6 is an end view of the drapery pin installer showing my new design; and,
FIG. 7 is a rear view of the drapery pin installer showing my new design.

1 Claim, 5 Drawing Sheets

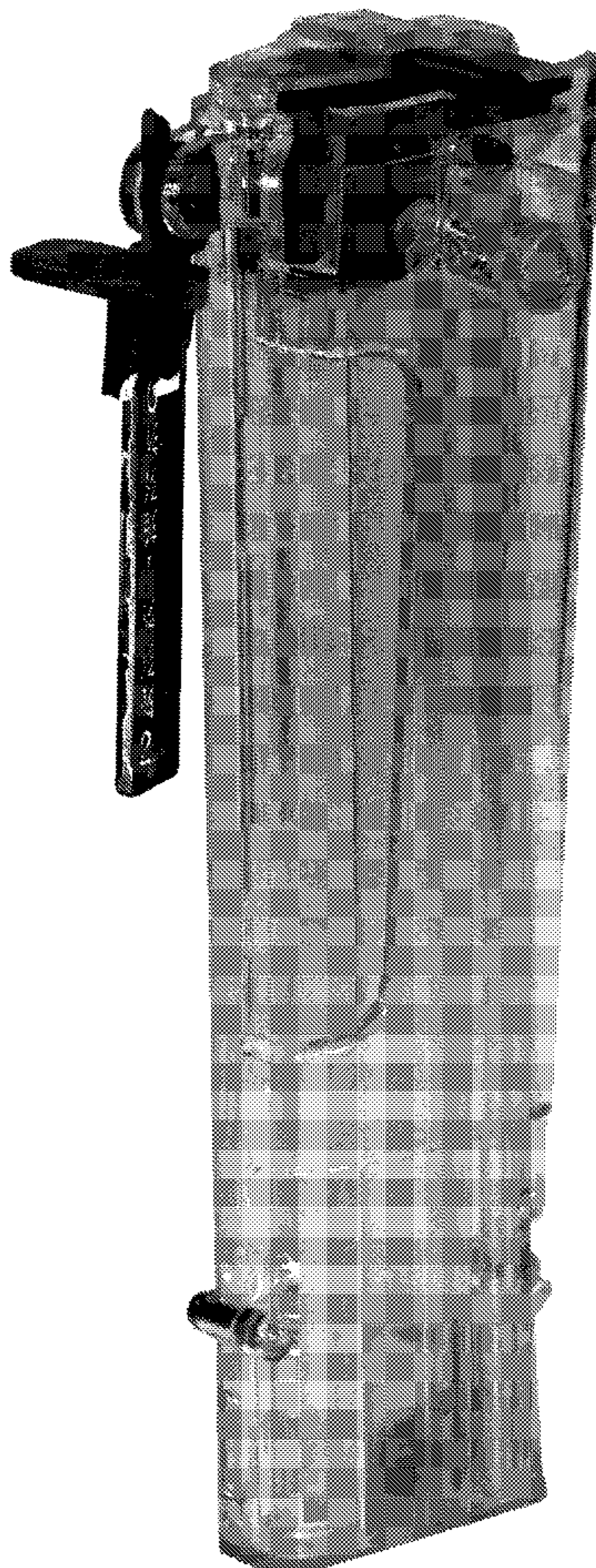

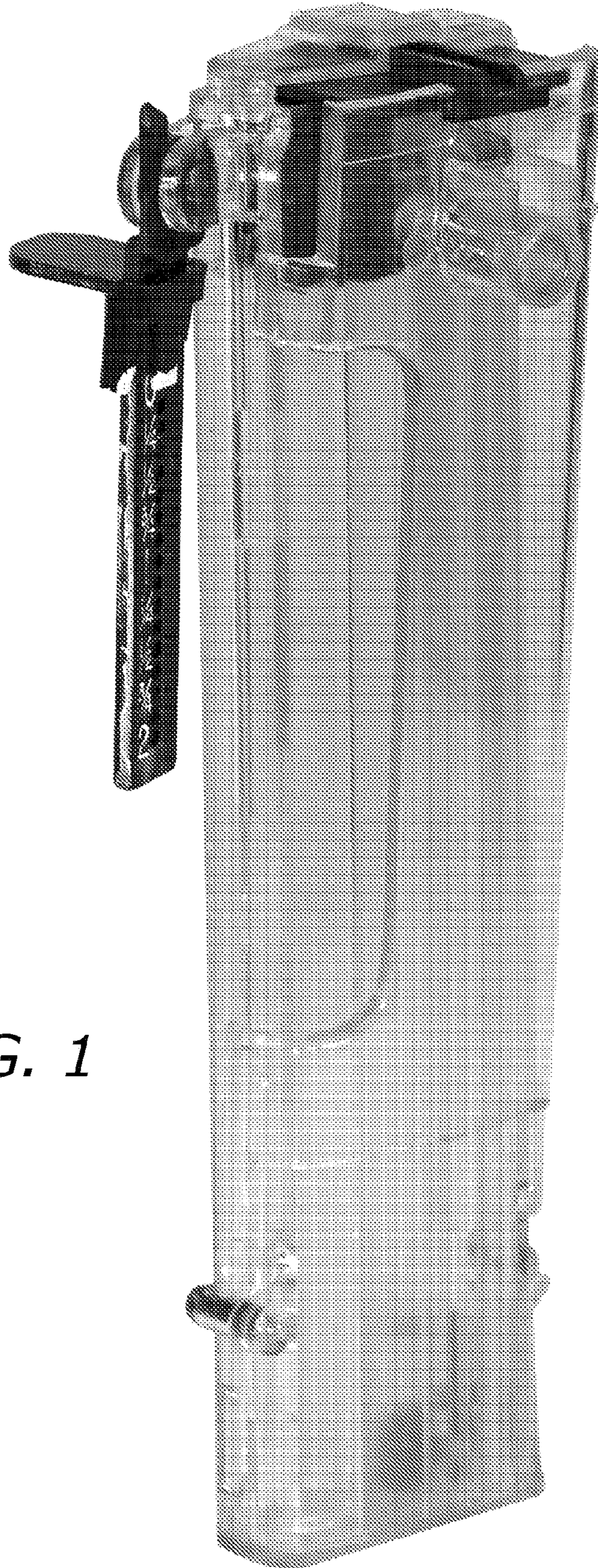

FIG. 1

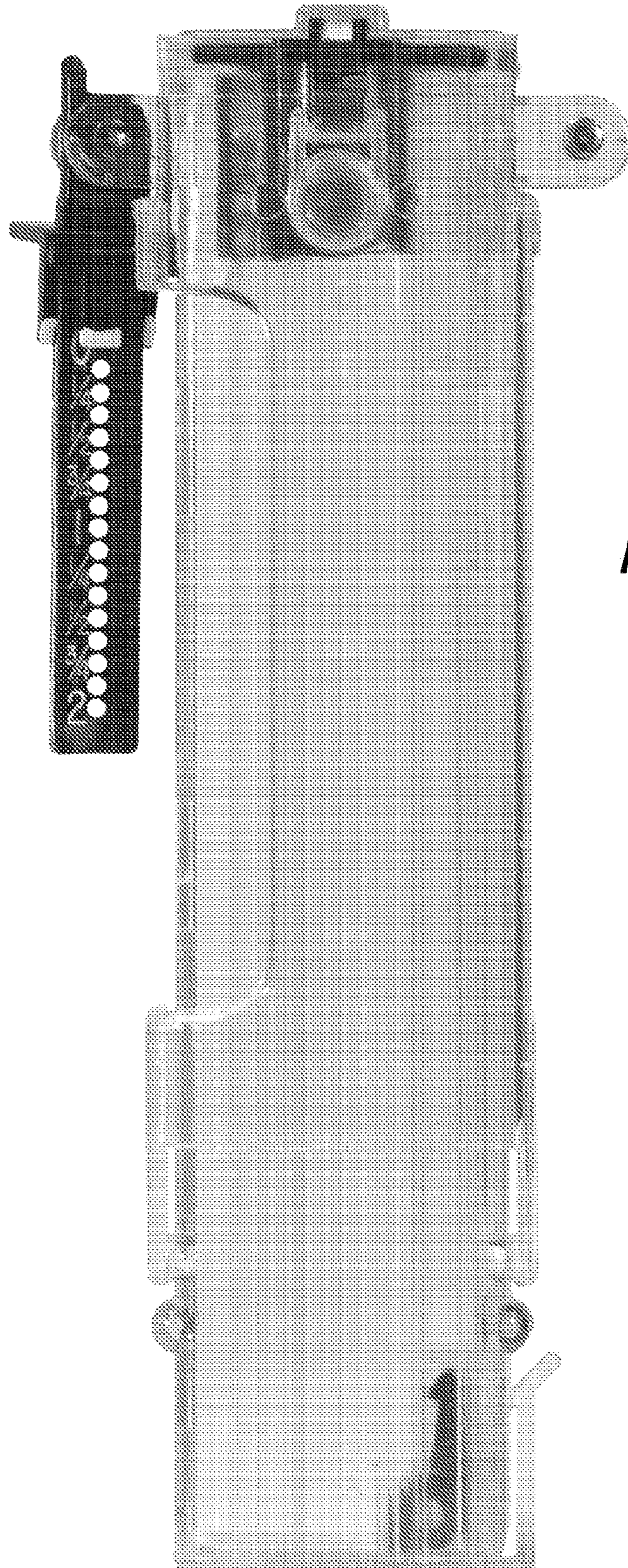
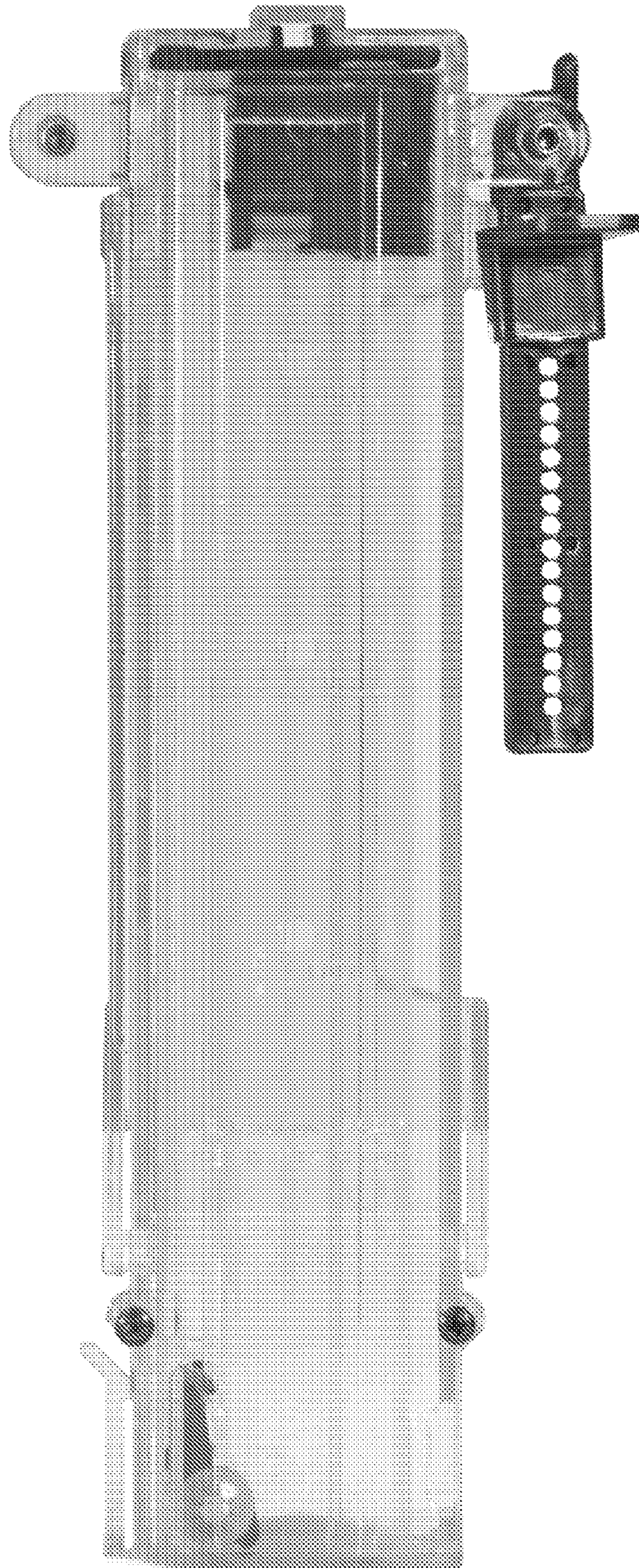

FIG. 2

FIG. 3



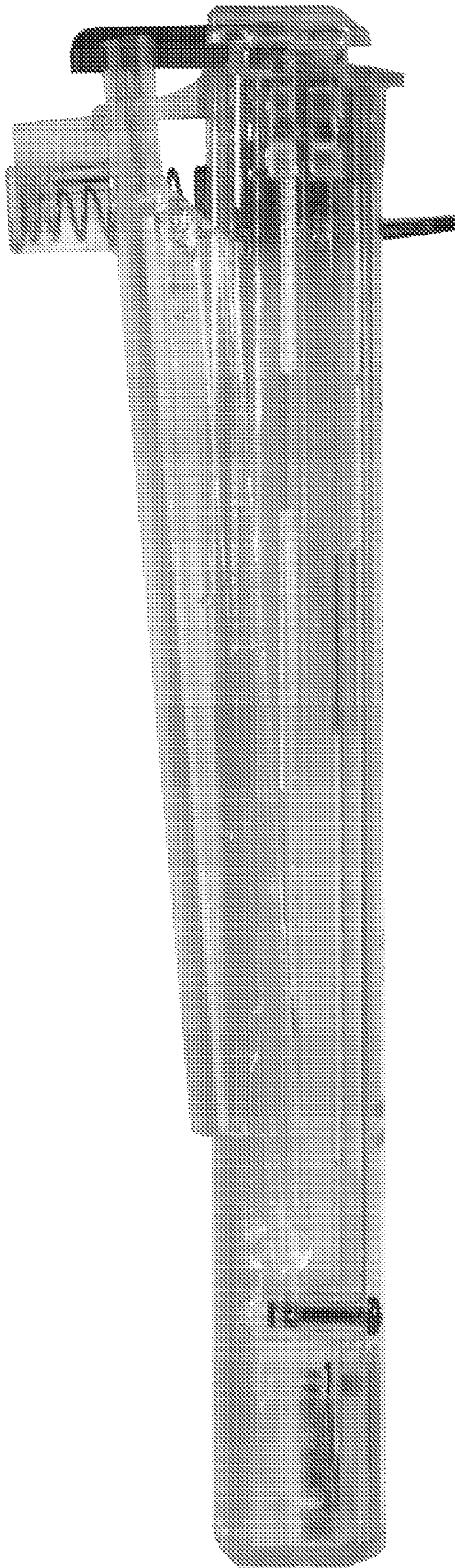

FIG. 4

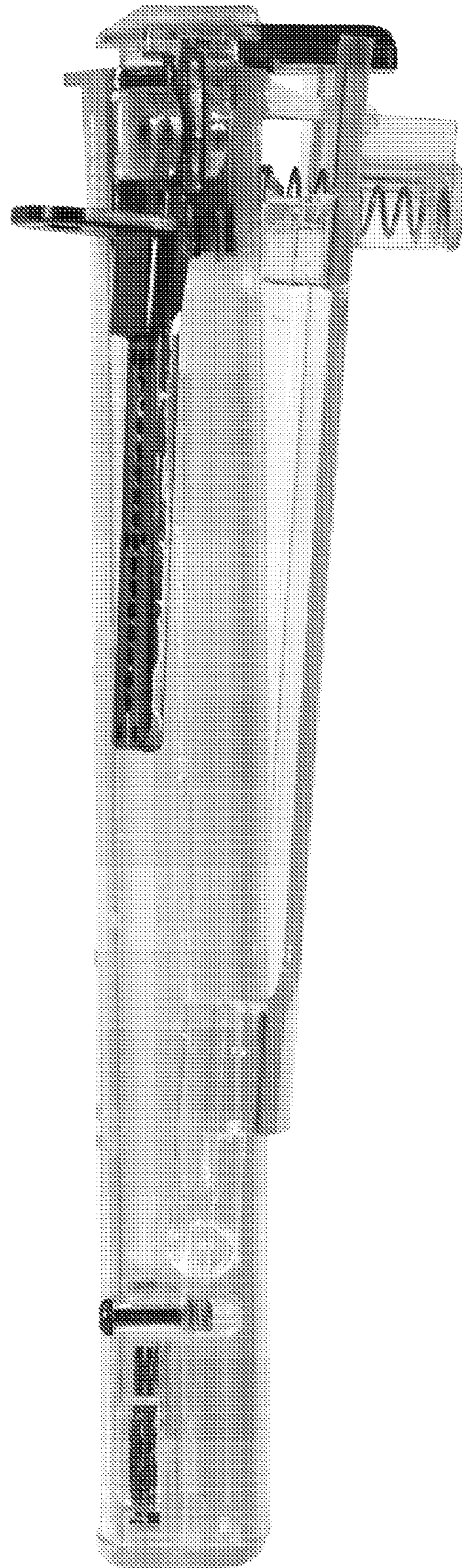

FIG. 5

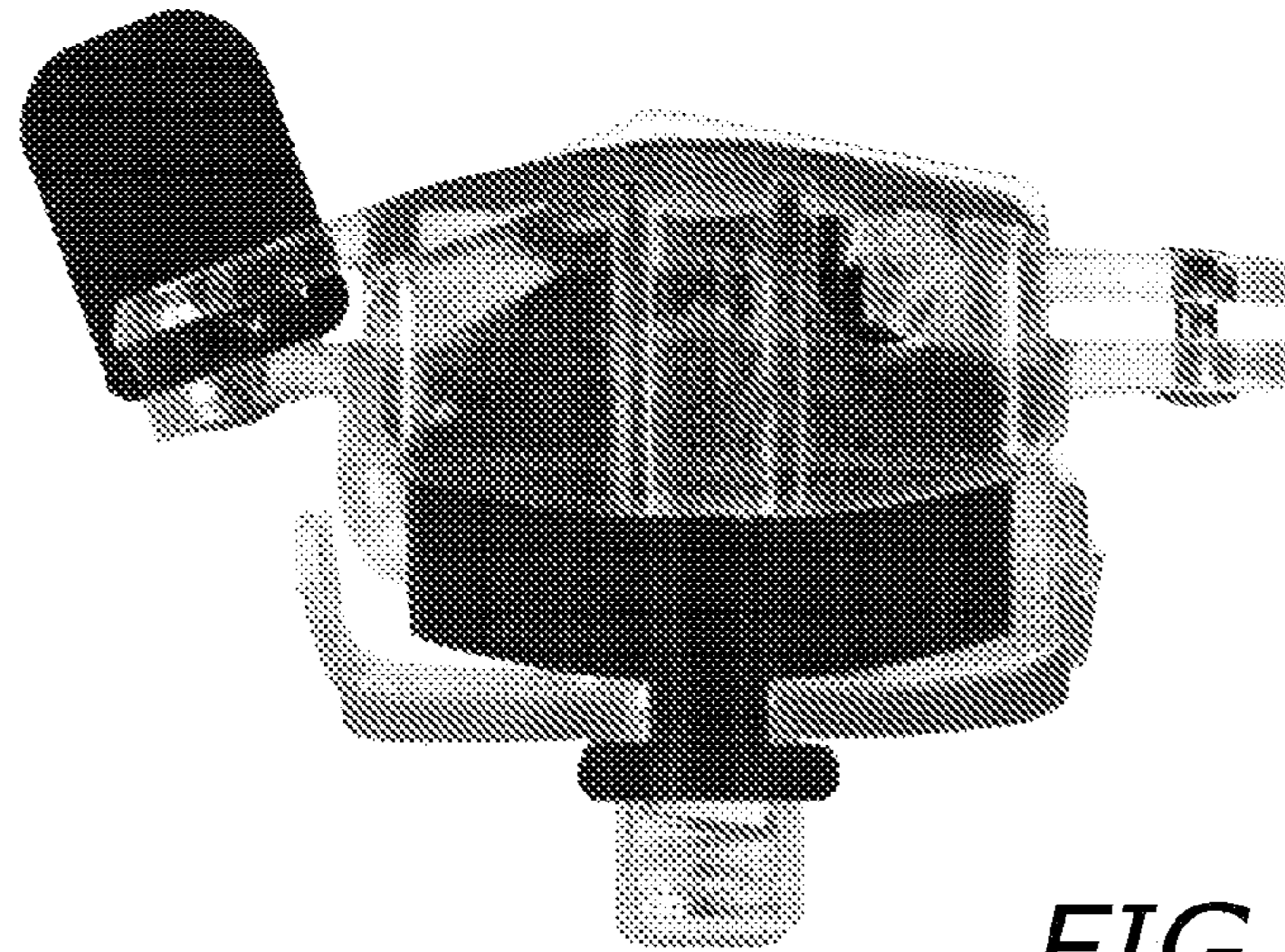

FIG. 6

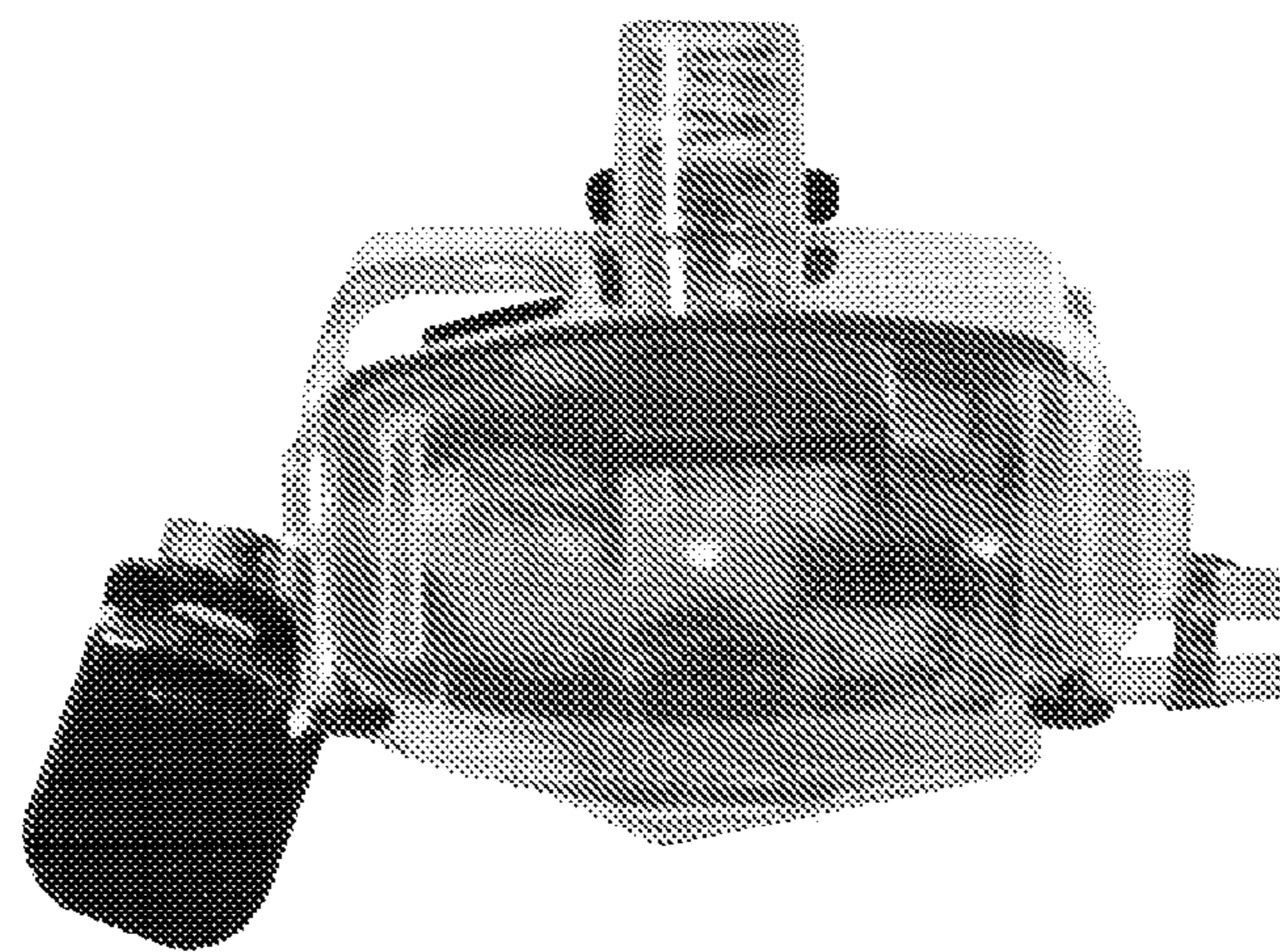

FIG. 7