



US00D678034S

(12) **United States Design Patent**
Stover, Jr.

(10) **Patent No.:** **US D678,034 S**

(45) **Date of Patent:** **** Mar. 19, 2013**

(54) **PLOW LOCK**

(76) **Inventor:** **Devere W. Stover, Jr.,** Marilla, NY (US)

(**) **Term:** **14 Years**

(21) **Appl. No.:** **29/401,718**

(22) **Filed:** **Sep. 14, 2011**

(51) **LOC (9) Cl.** **08-07**

(52) **U.S. Cl.** **D8/330**

(58) **Field of Classification Search** D8/1, 330,
D8/331, 336, 339, 343, 341, 349; 70/1, 14,
70/19, 51, 57, 57.1, 141, 266, 416, 431, 466,
70/DIG. 9; 292/289, 290, 292, 298
See application file for complete search history.

(56) **References Cited**

U.S. PATENT DOCUMENTS

D176,932	S	*	2/1956	Schloage	D8/354
3,570,283	A	*	3/1971	Males	70/14
3,604,517	A	*	9/1971	Clifford	172/225
4,415,040	A	*	11/1983	Salva	172/225
D272,041	S	*	1/1984	Harris et al.	D8/330
4,646,849	A	*	3/1987	Watvedt	172/225
5,000,267	A	*	3/1991	Harrell	172/219
5,076,368	A	*	12/1991	Harrell	172/219
6,327,878	B1	*	12/2001	Levenson	70/14

D479,792	S	*	9/2003	Winocoor	D8/331
D479,975	S	*	9/2003	Winocoor	D8/331
D544,337	S	*	6/2007	Pepper et al.	D8/331
D564,859	S	*	3/2008	Brojanac et al.	D8/330

* cited by examiner

Primary Examiner — Prabhakar Deshmukh

(74) *Attorney, Agent, or Firm* — Phillips Lytle LLP

(57) **CLAIM**

The ornamental design for a plow lock, as shown and described.

DESCRIPTION

FIG. 1 is a perspective view of a plow lock showing my new design, shown in its environmental use;
FIG. 2 is a perspective view thereof;
FIG. 3 is a front elevational view thereof;
FIG. 4 is a rear elevational view thereof;
FIG. 5 is a bottom plan view thereof;
FIG. 6 is a top plan view thereof;
FIG. 7 is a right side elevational view thereof; and,
FIG. 8 is a left side elevational view thereof.
The broken lines environment is for illustrative purpose only and forms no part of the claimed design.

1 Claim, 3 Drawing Sheets

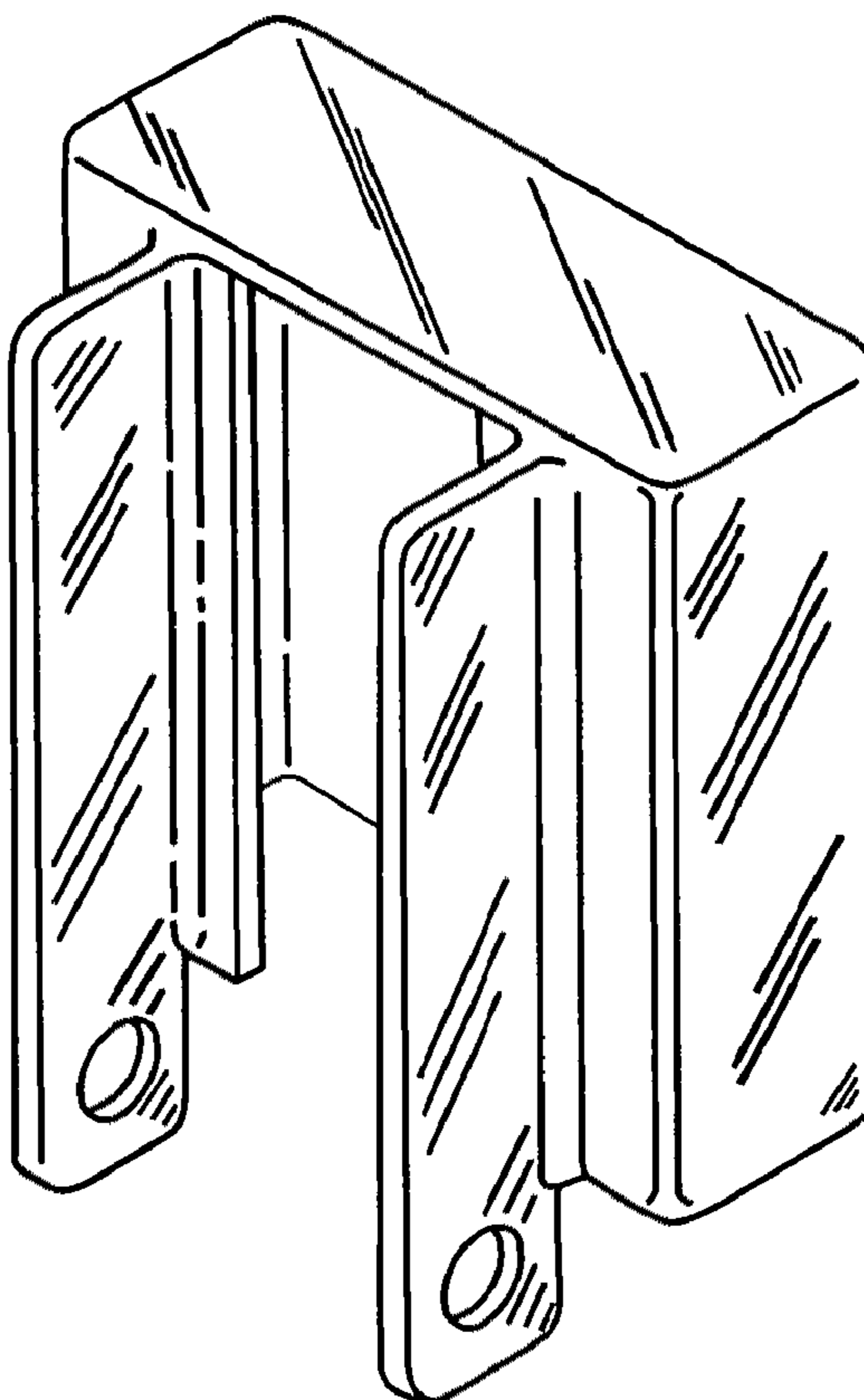

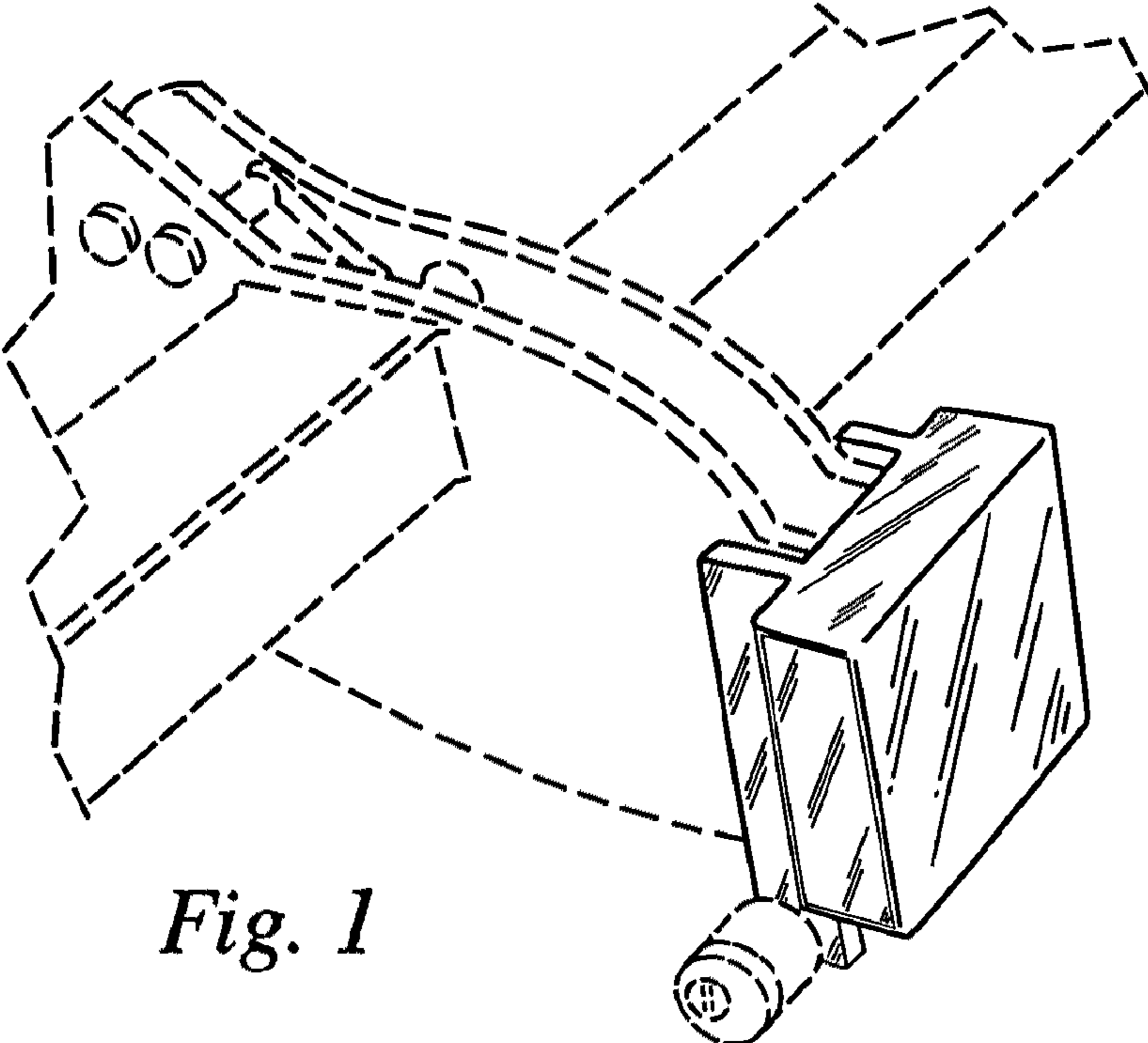

Fig. 1

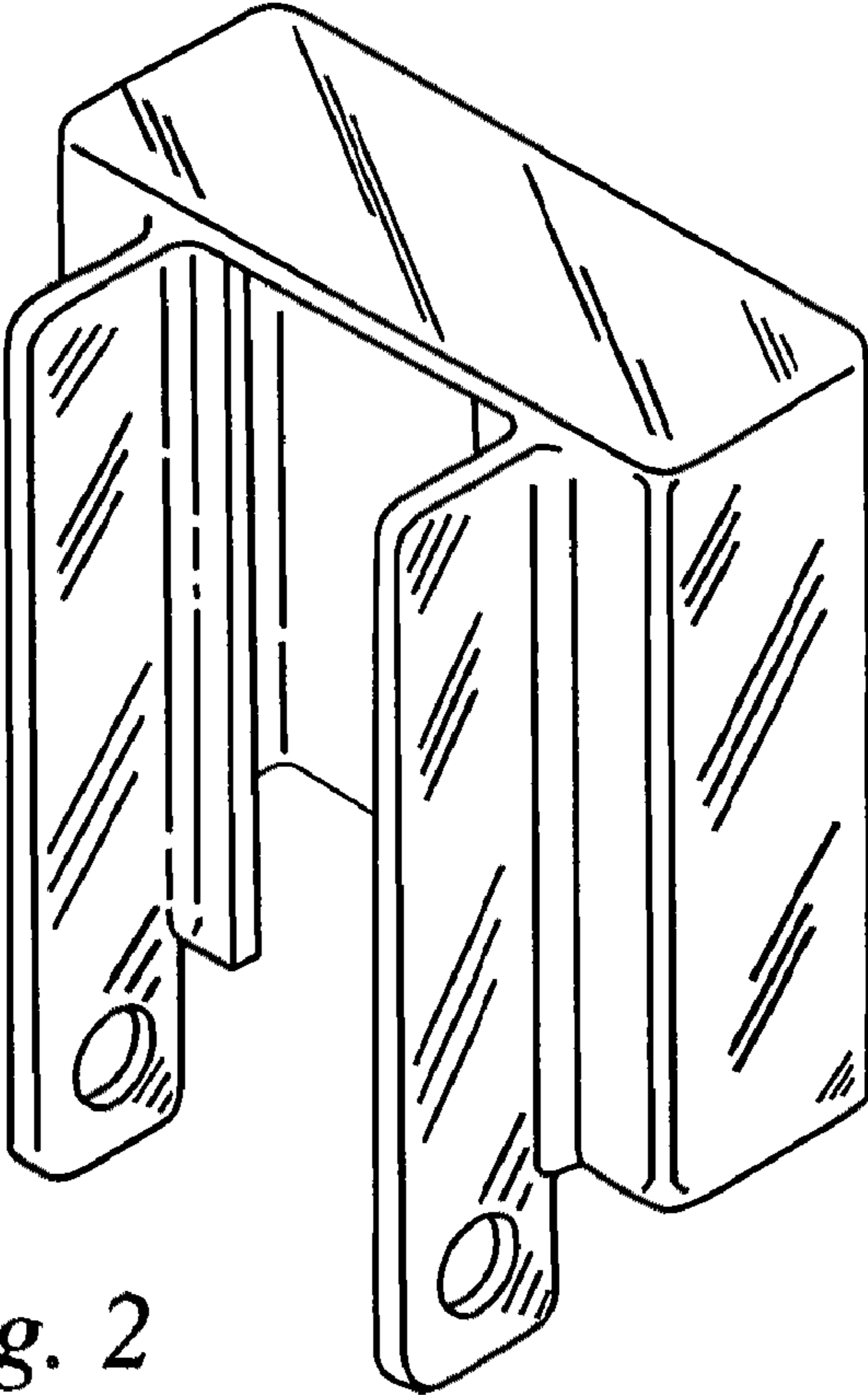

Fig. 2

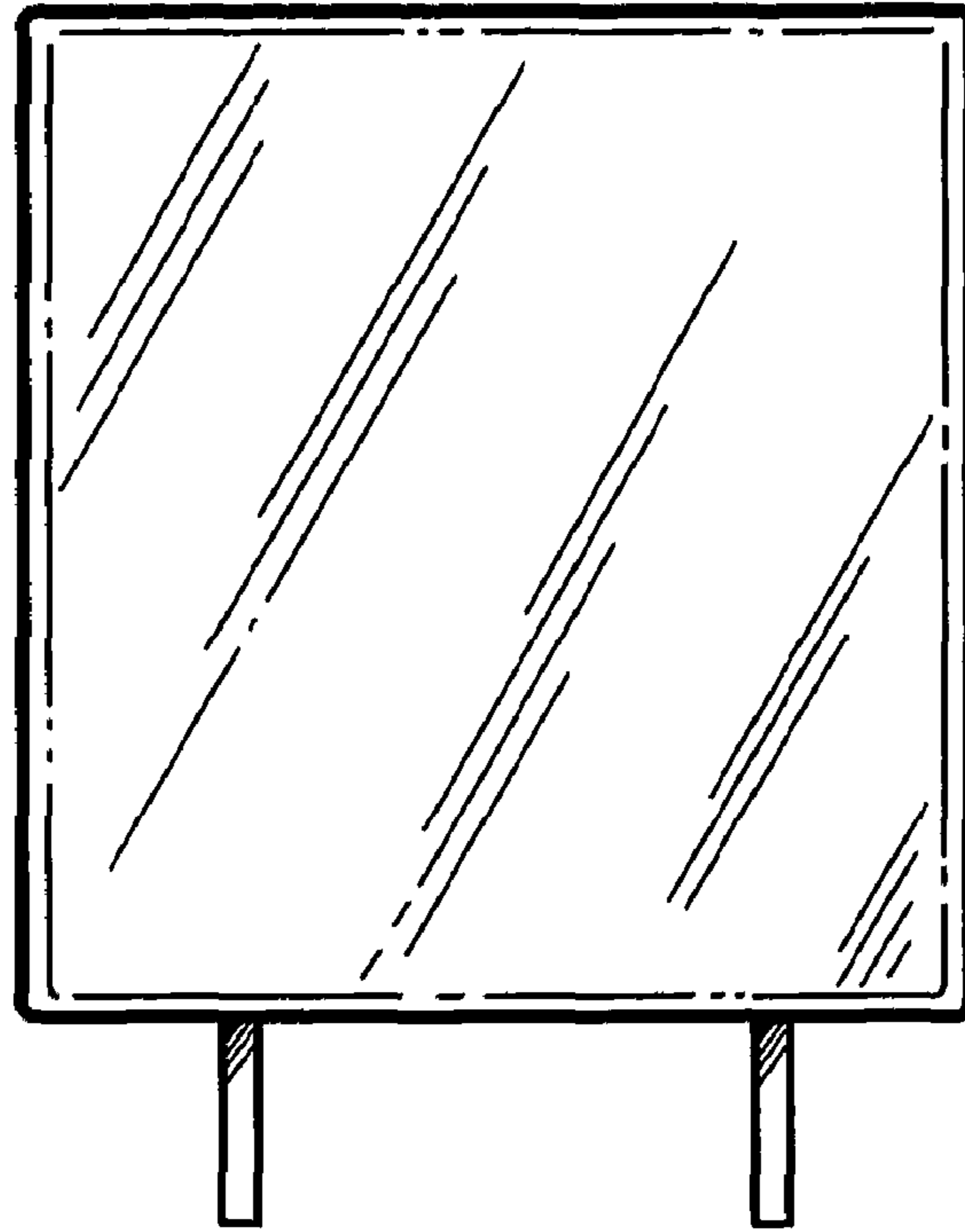

Fig. 3

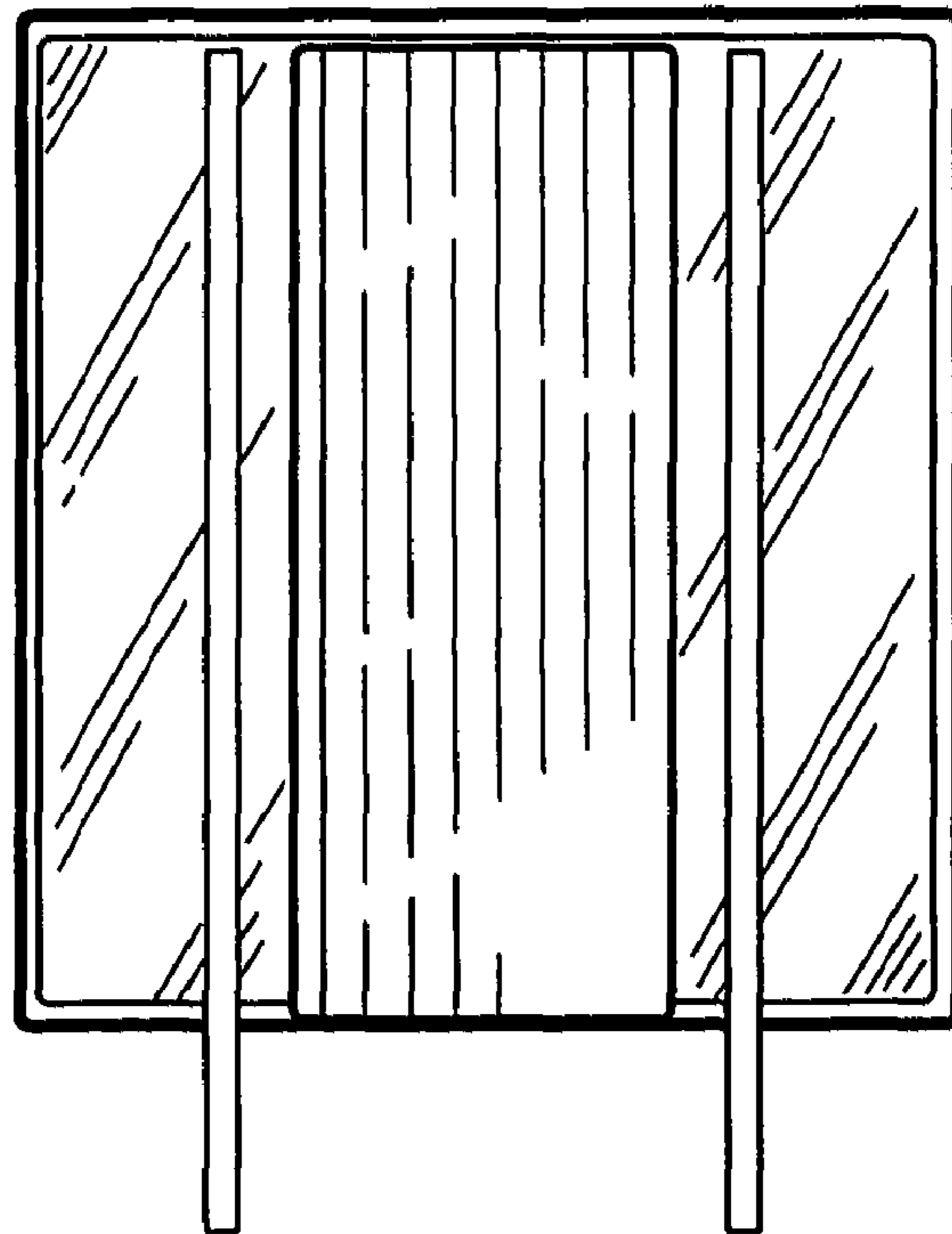

Fig. 4

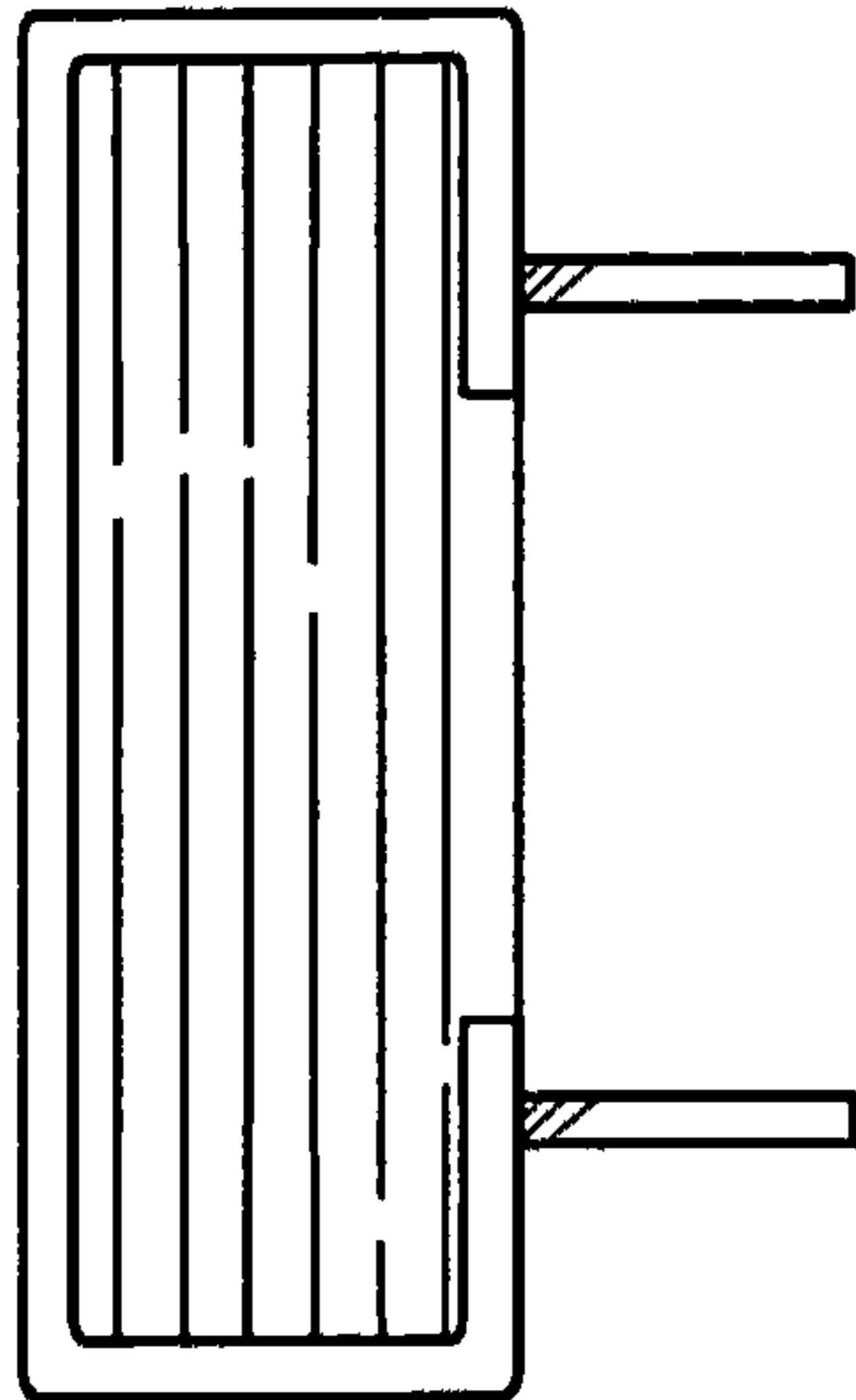

Fig. 5

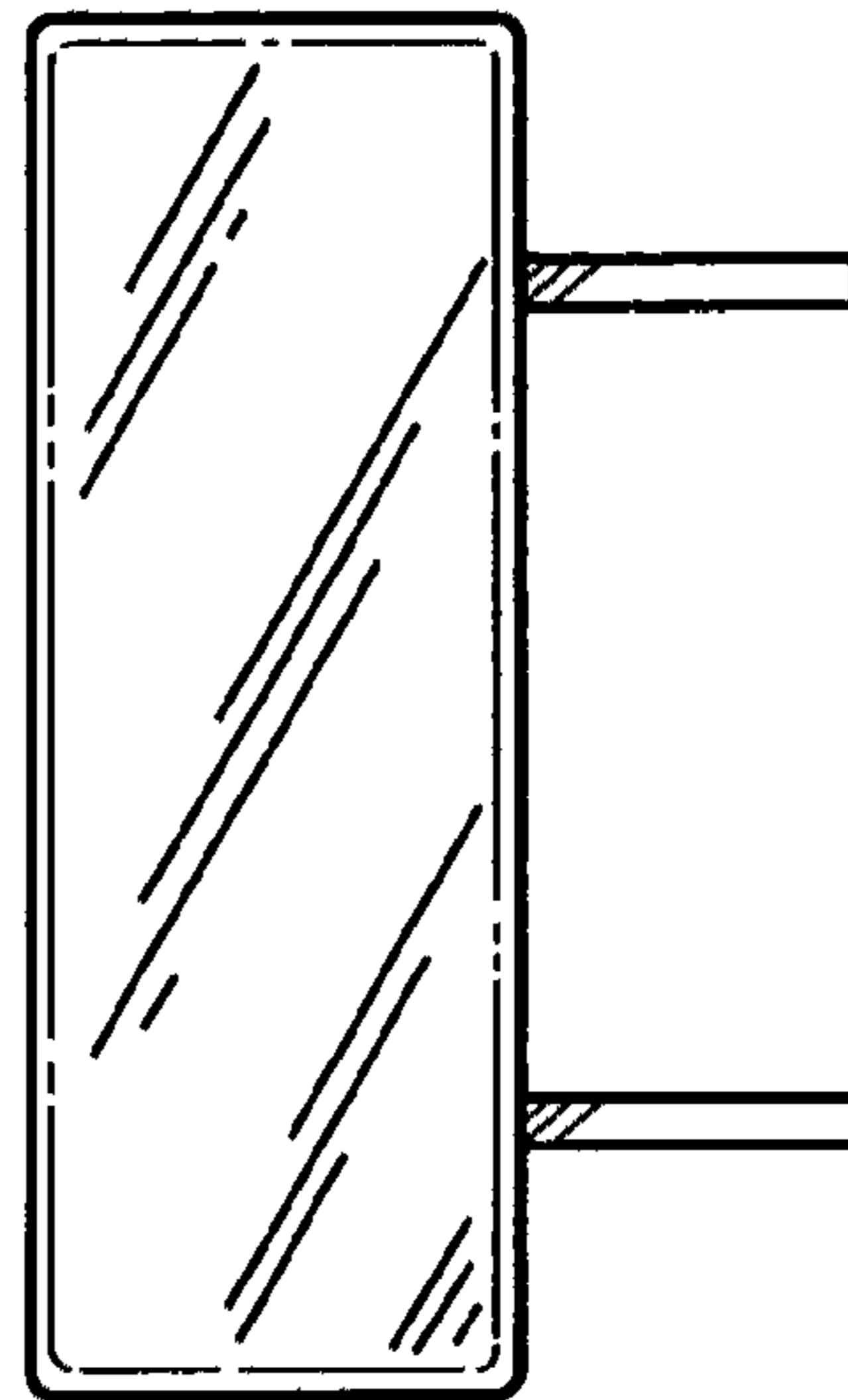

Fig. 6

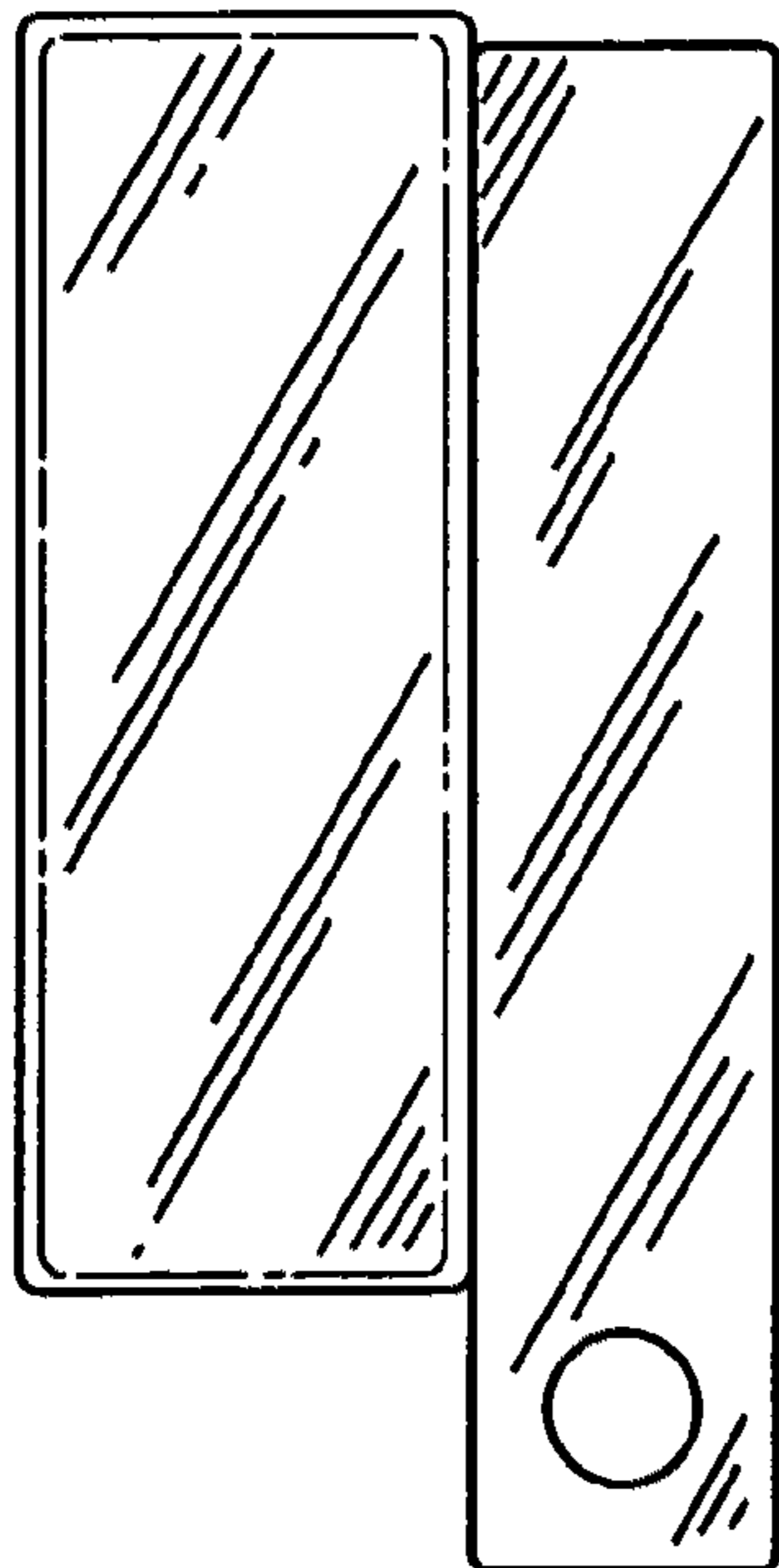

Fig. 7

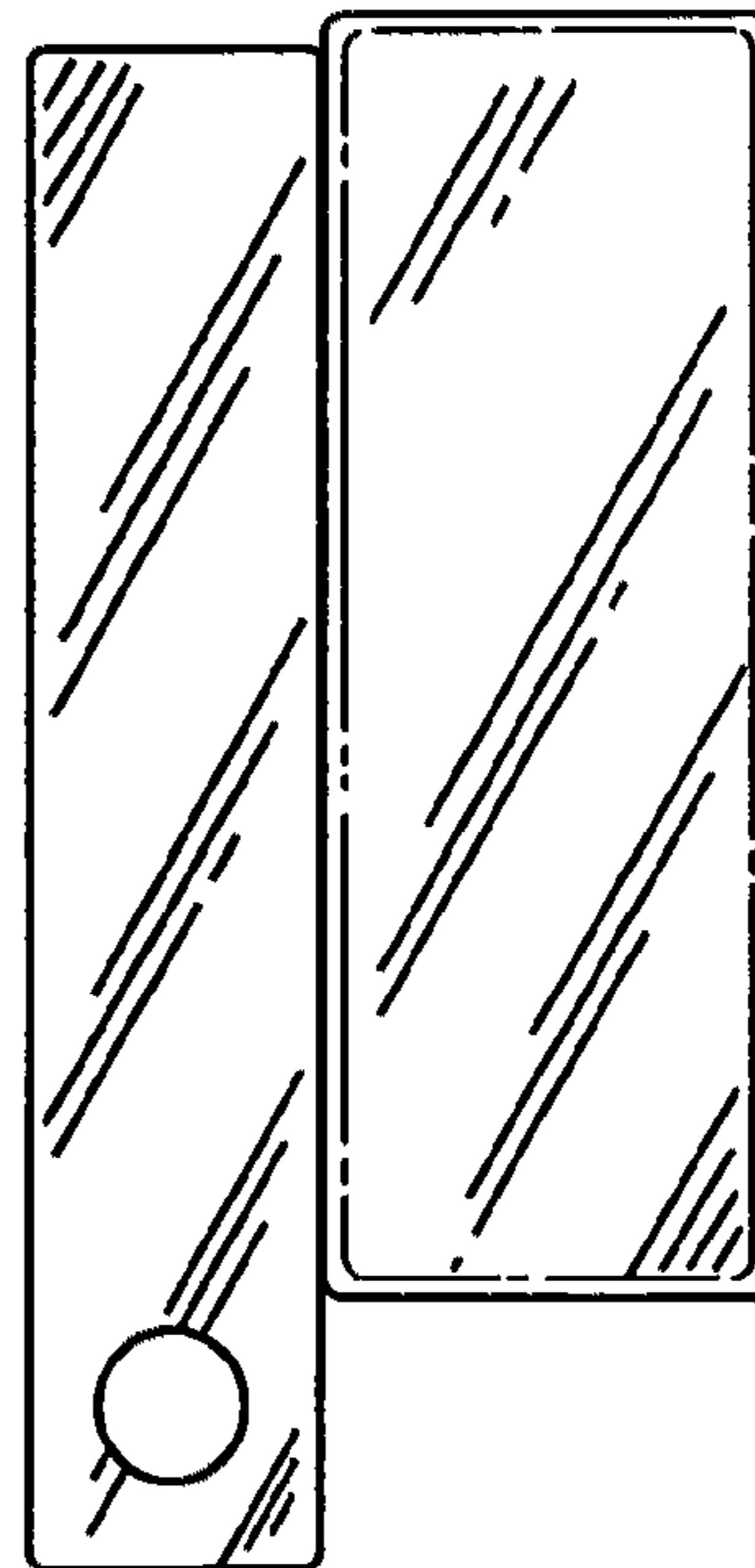

Fig. 8