



US00D677926S

(12) **United States Design Patent**
Costano Fernandez

(10) **Patent No.:** **US D677,926 S**
(45) **Date of Patent:** **** Mar. 19, 2013**

(54) **PORTABLE BABY BED**

(76) Inventor: **Ana Lourdes Costano Fernandez,**
Arlington, TX (US)

(**) Term: **14 Years**

(21) Appl. No.: **29/416,738**

(22) Filed: **Mar. 26, 2012**

(51) **LOC (9) Cl.** **06-02**

(52) **U.S. Cl.** **D6/390; D6/382**

(58) **Field of Classification Search** D6/382-384,
D6/390-395, 505-508, 397, 331; 5/53.1,
5/279.1, 280, 281, 907, 2.1, 8, 9.1, 93.1,
5/98.1, 101

See application file for complete search history.

(56) **References Cited**

U.S. PATENT DOCUMENTS

D113,147 S * 1/1939 Root D6/377
D181,771 S * 12/1957 Wilson D6/335
D209,897 S * 1/1968 Ikeda D6/393

D295,904 S * 5/1988 McMahon D30/118
D553,805 S * 10/2007 Martin et al. D30/118
D598,211 S * 8/2009 Mourgue D6/393

* cited by examiner

Primary Examiner — Janice Seeger

(74) *Attorney, Agent, or Firm* — QuickPatents; Kevin Prince

(57) **CLAIM**

I claim the ornamental design for a portable baby bed, as shown and described.

DESCRIPTION

FIG. 1 is a perspective view of a portable baby bed, showing my new design;

FIG. 2 is a front elevational view;

FIG. 3 is a rear elevational view;

FIG. 4 is a left side elevational view;

FIG. 5 is a right side elevational view;

FIG. 6 is a top plan view; and,

FIG. 7 is a bottom plan view thereof.

1 Claim, 3 Drawing Sheets

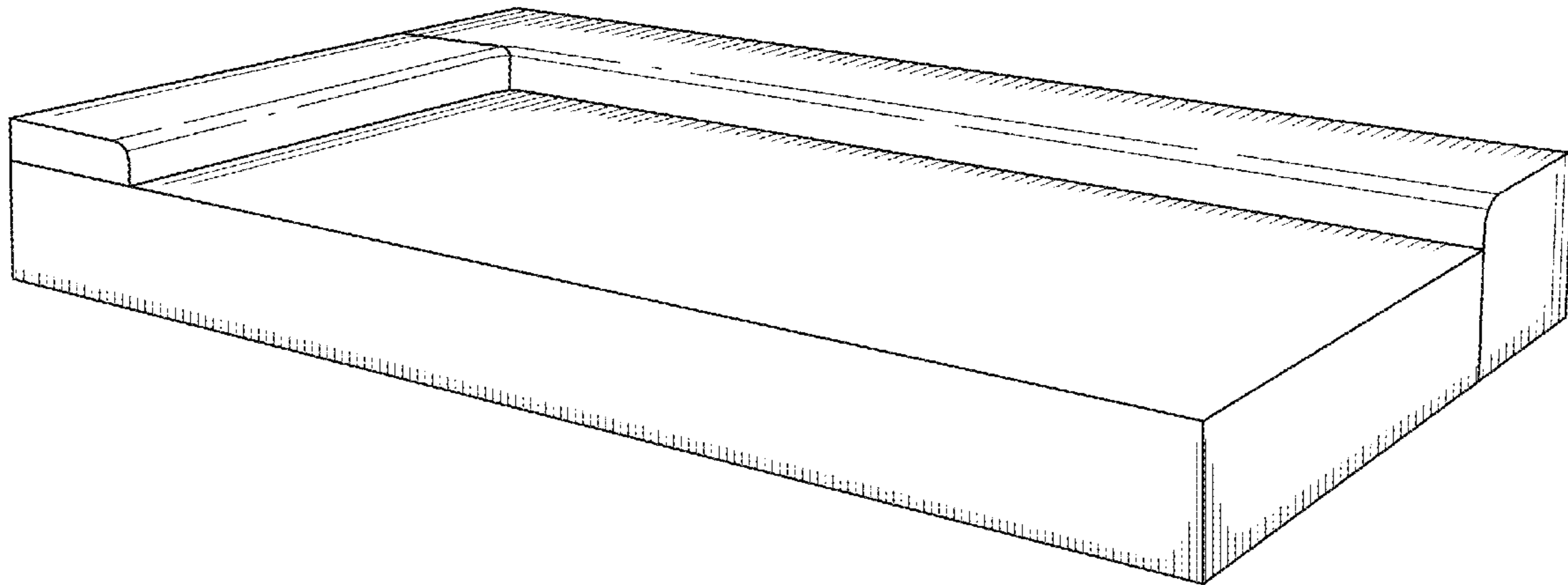

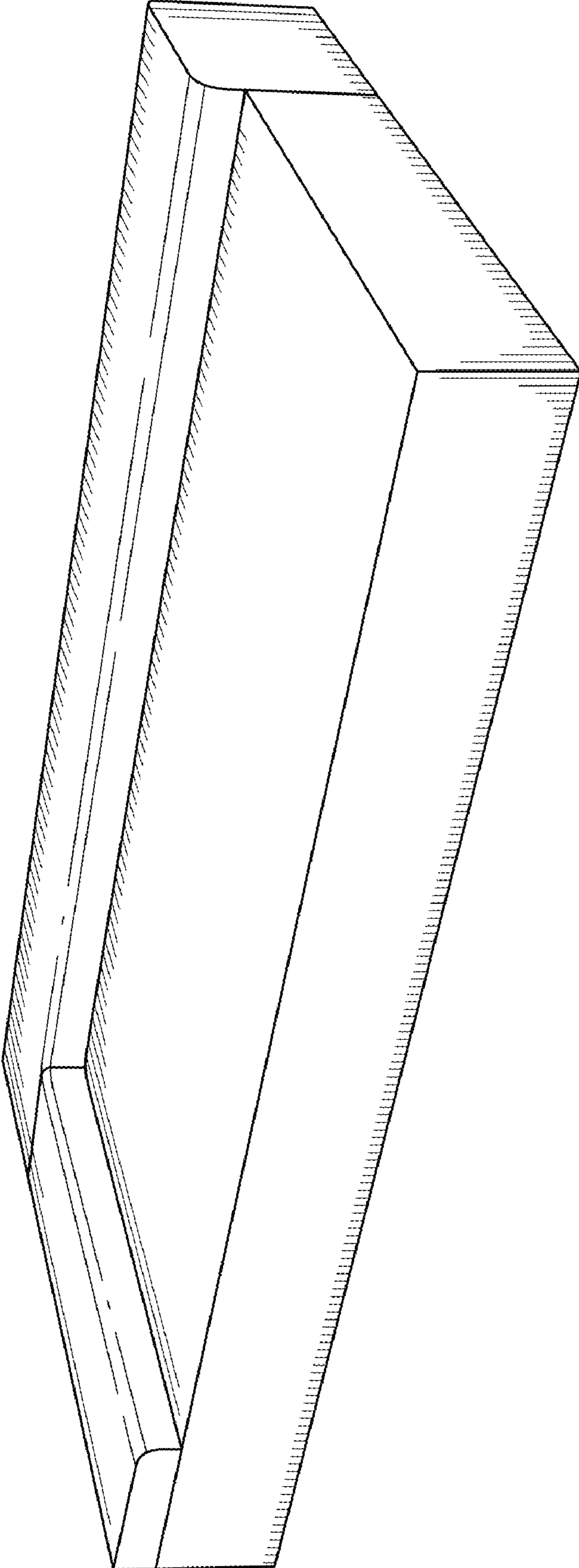

FIG. 1

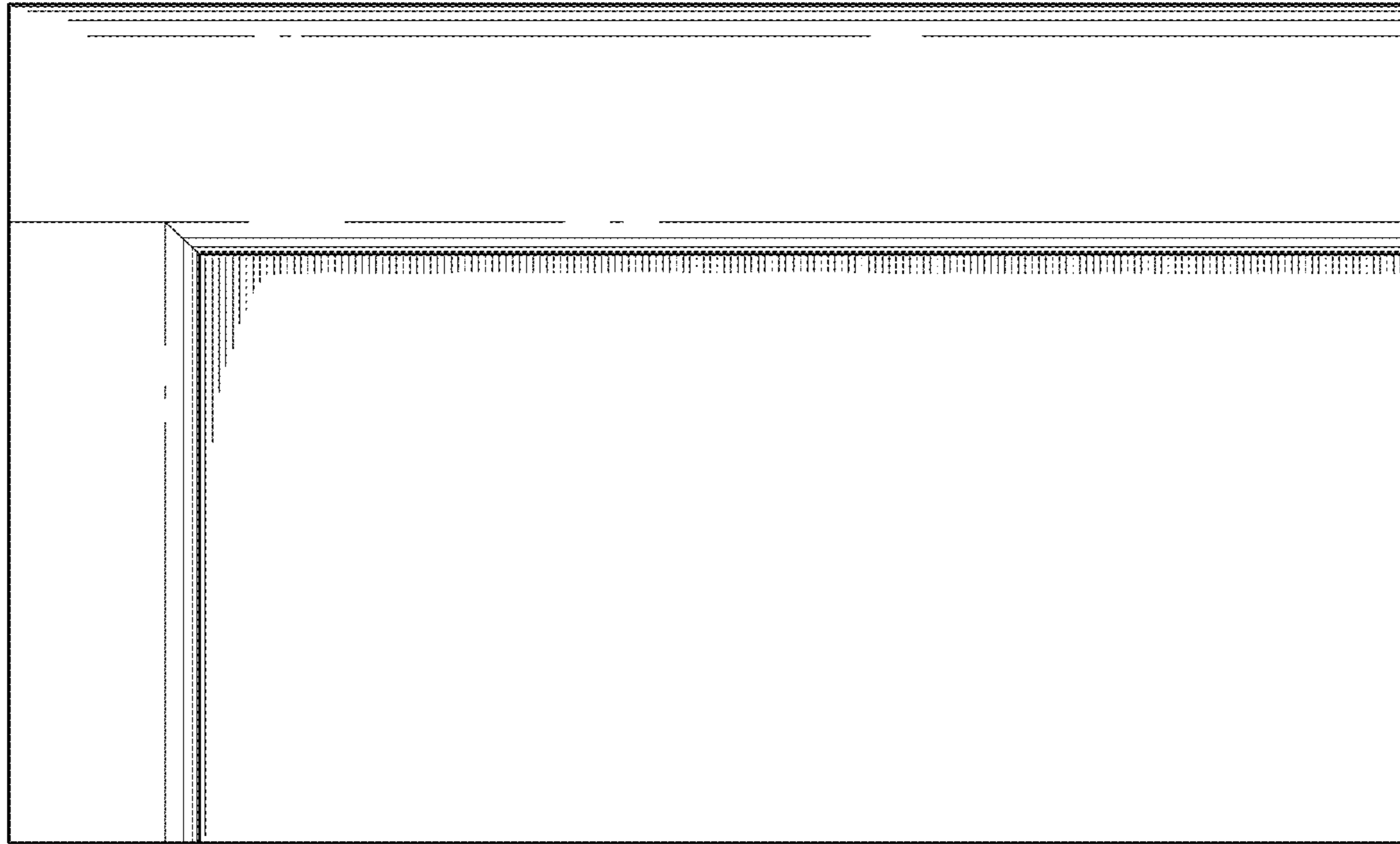

FIG. 6

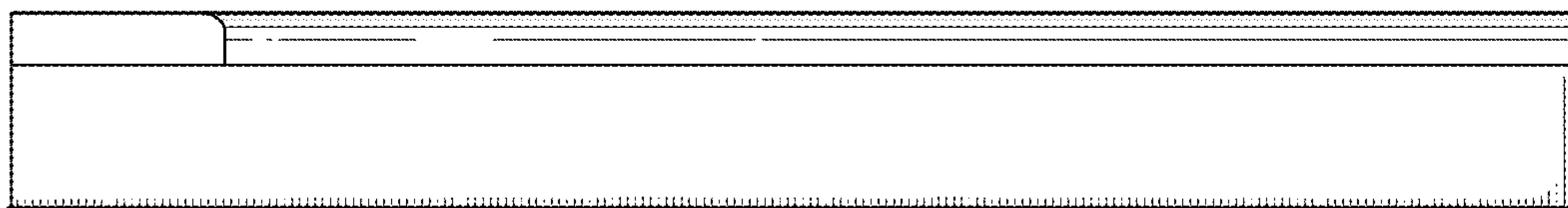

FIG. 2

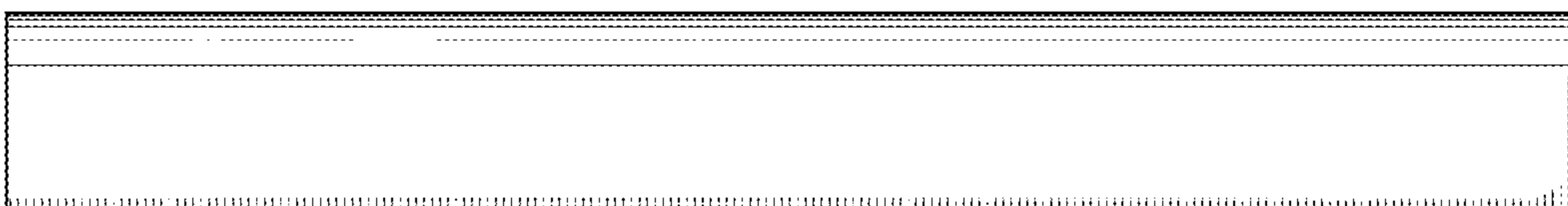

FIG. 3

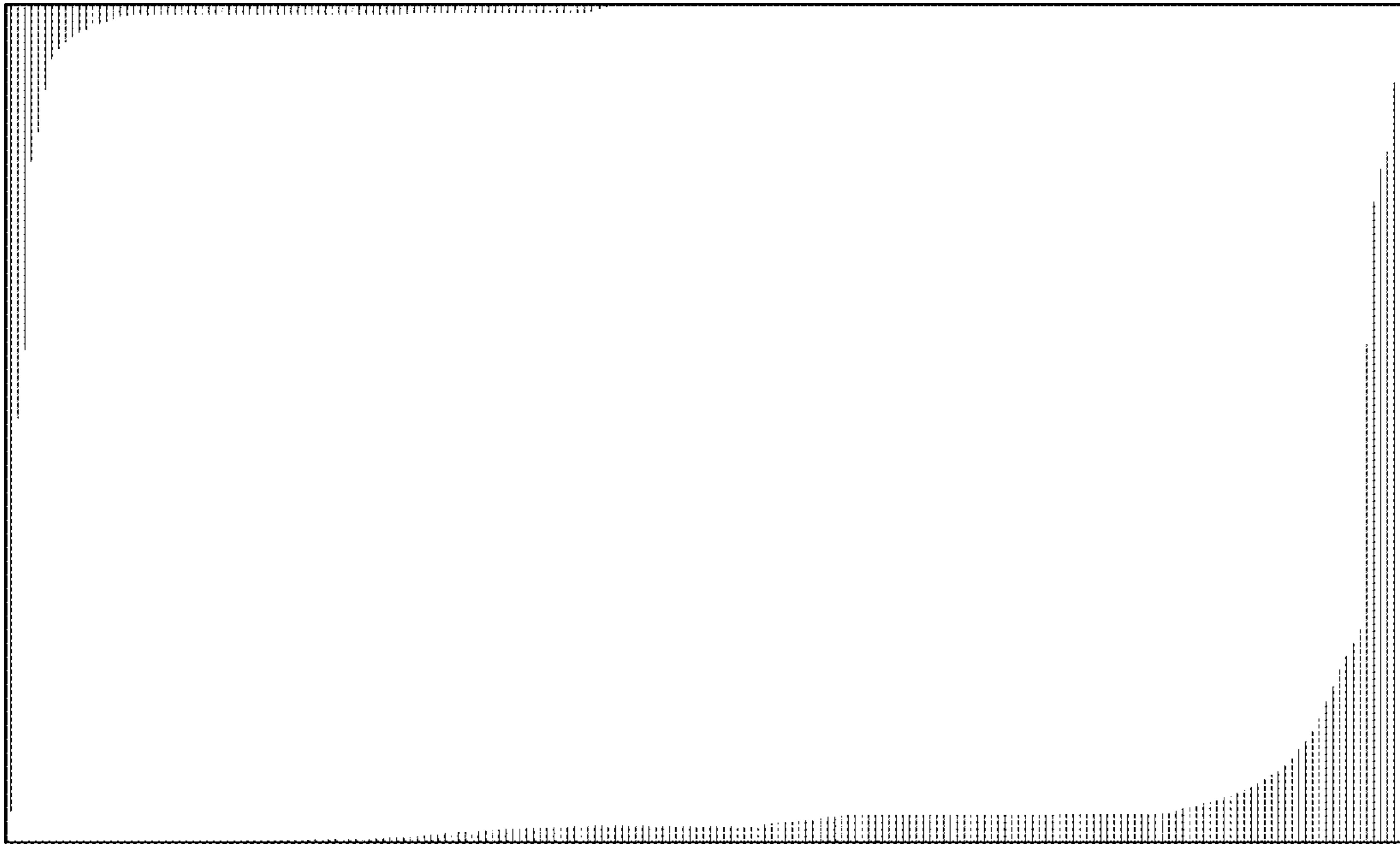

FIG. 7

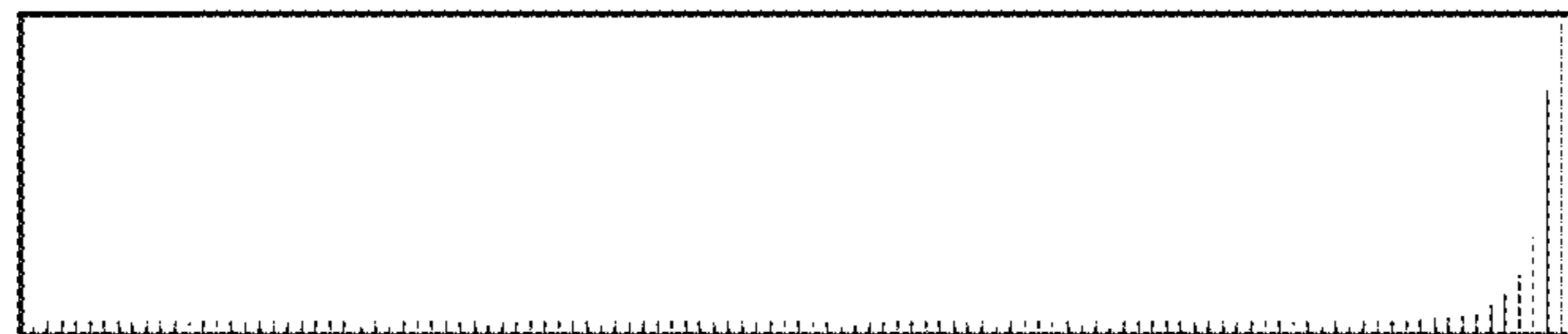

FIG. 4

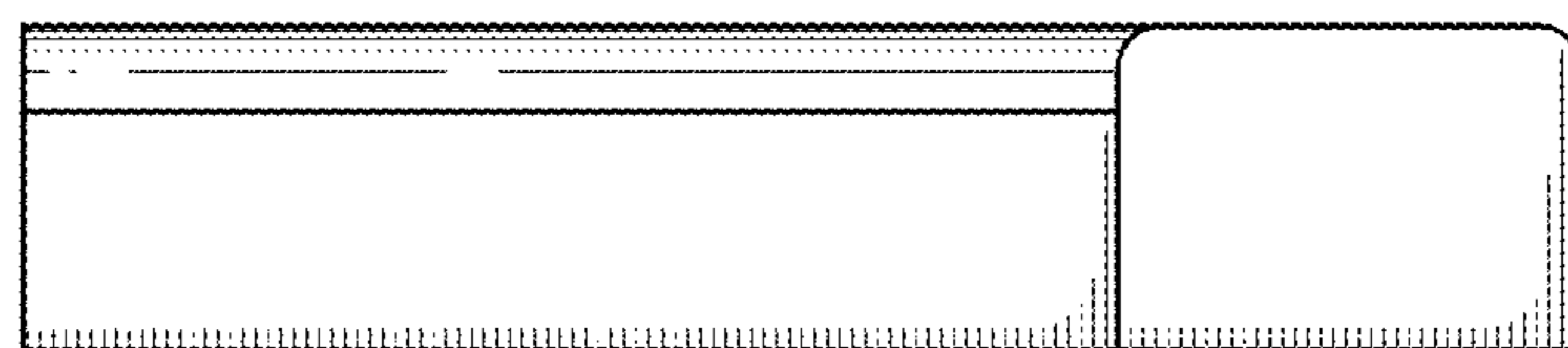

FIG. 5