



US00D677894S

(12) **United States Design Patent**  
**Santivasci**

(10) **Patent No.:** **US D677,894 S**  
(45) **Date of Patent:** **\*\* Mar. 19, 2013**

(54) **CHILD BACKPACK STRAP DECORATIVE COVERS**

(76) Inventor: **Patrick V. Santivasci**, North Massapequa, NY (US)

(\*\*) Term: **14 Years**

(21) Appl. No.: **29/393,323**

(22) Filed: **Jun. 2, 2011**

(51) **LOC (9) Cl.** ..... **03-01**

(52) **U.S. Cl.** ..... **D3/318**

(58) **Field of Classification Search** ..... D3/300, D3/302, 282, 201, 203.2, 203.5, 206, 269, D3/273, 293, 905, 247-250, 261, 231, 327, D3/318, 214, 216, 304; D7/612; D9/418, D9/707, 709; 206/216, 223, 372, 379, 549, 206/473, 39, 39.5, 776, 530-534, 540; 190/108-111; 224/264, 600; D2/639, 218  
See application file for complete search history.

(56) **References Cited**

**U.S. PATENT DOCUMENTS**

D275,153	S *	8/1984	Weinreb	.....	D3/327
4,575,874	A	3/1986	Johnson		
4,945,576	A	8/1990	Melton		
D320,110	S *	9/1991	Hawkins	.....	D2/639
D325,470	S	4/1992	Harms		
D351,279	S *	10/1994	Montgomery	.....	D3/215
5,388,743	A	2/1995	Silagy		
5,441,188	A *	8/1995	Rosenstein	.....	224/264
D363,154	S *	10/1995	Petty	.....	D2/639
D369,671	S *	5/1996	Gordon	.....	D2/639
5,551,614	A *	9/1996	Ham	.....	224/264
5,566,871	A	10/1996	Weintraub		
5,595,332	A *	1/1997	Freedman	.....	224/264

D423,782	S	5/2000	Ammerman et al.		
6,282,725	B1 *	9/2001	Vanidestine, Jr.	.....	2/421
6,592,003	B2 *	7/2003	Silverthorne	.....	221/60
D488,929	S	4/2004	Nordstrom et al.		
D489,890	S *	5/2004	Gorham, Jr.	.....	D3/218
D570,603	S	6/2008	Wu et al.		
D572,901	S *	7/2008	St. George	.....	D3/218
D583,154	S *	12/2008	Gonzalez	.....	D3/318
D648,920	S *	11/2011	Dorsey	.....	D2/639
D653,017	S *	1/2012	Hamlin	.....	D2/639
D662,277	S *	6/2012	Dorsey	.....	D2/639
2001/0054630	A1	12/2001	Crabill		
2007/0245526	A1	10/2007	Fidrych et al.		

\* cited by examiner

*Primary Examiner* — Sheryl Lane

(57) **CLAIM**

The ornamental design for a child backpack strap decorative covers, as shown and described.

**DESCRIPTION**

FIG. 1 is a perspective view of a child backpack strap decorative covers showing my new design; FIG. 2 is a front view thereof; FIG. 3 is a back view thereof; FIG. 4 is a top view thereof; FIG. 5 is a bottom view thereof; FIG. 6 is a side view (opposite side view is mirror image) thereof; and, FIG. 7 is another front view thereof. In FIGS. 1, 2, and 7, the broken lines showing of environmental structure for purposes of illustrating the child backpack strap decorative covers in a condition of use. The broken lines and the structure they depict form no part of the claimed design.

**1 Claim, 4 Drawing Sheets**

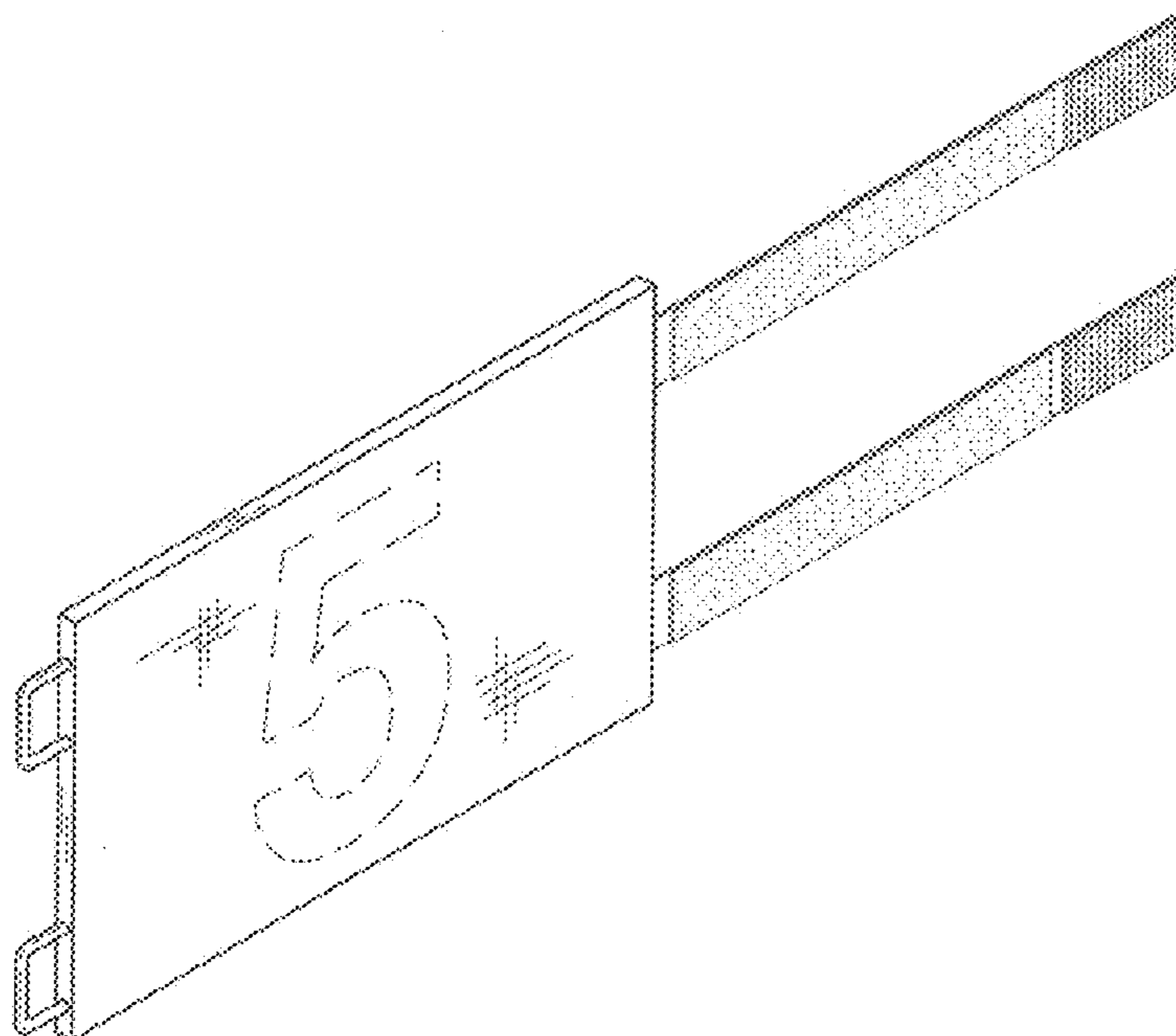

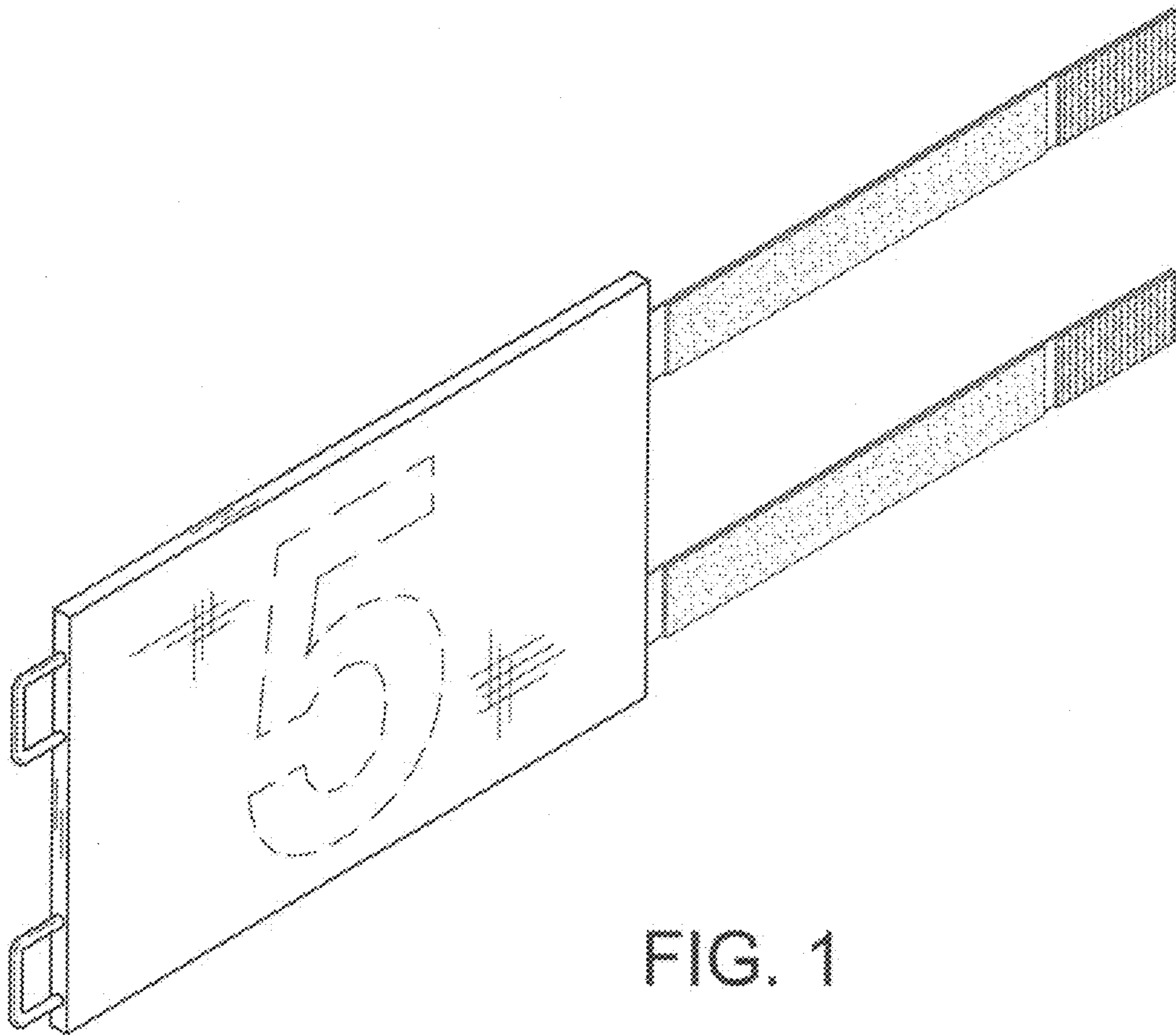

FIG. 1

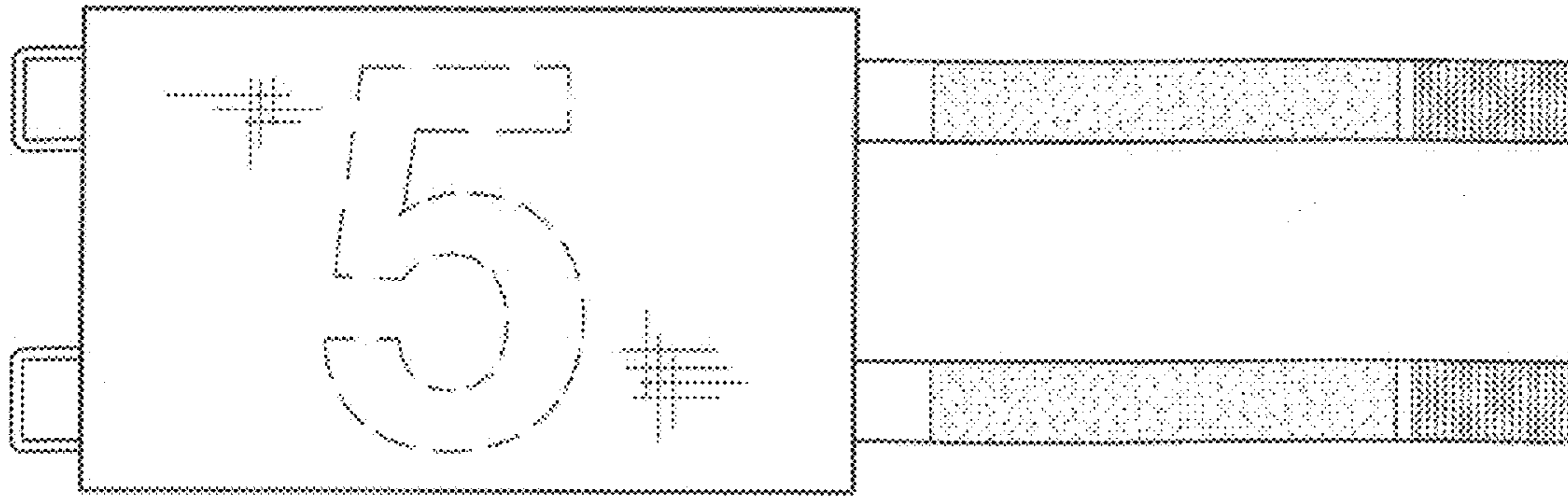

FIG. 2

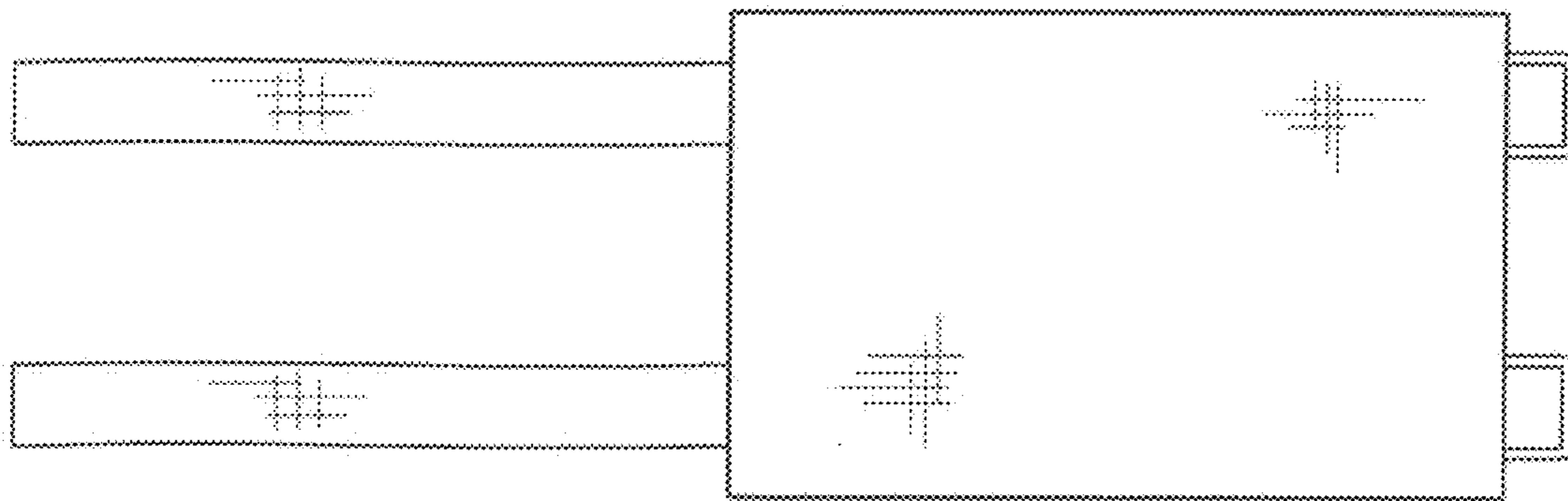

FIG. 3

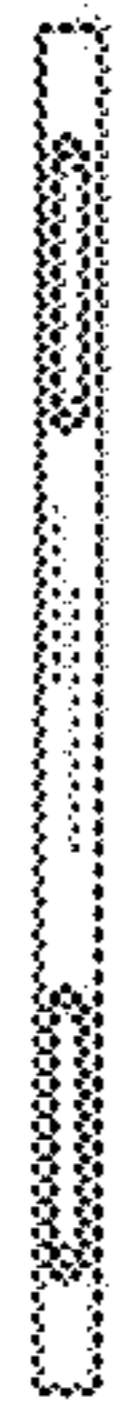

FIG. 4



FIG. 5

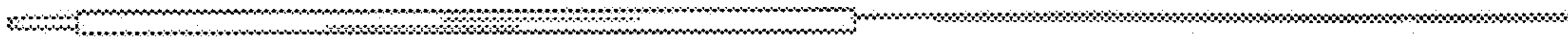

FIG. 6

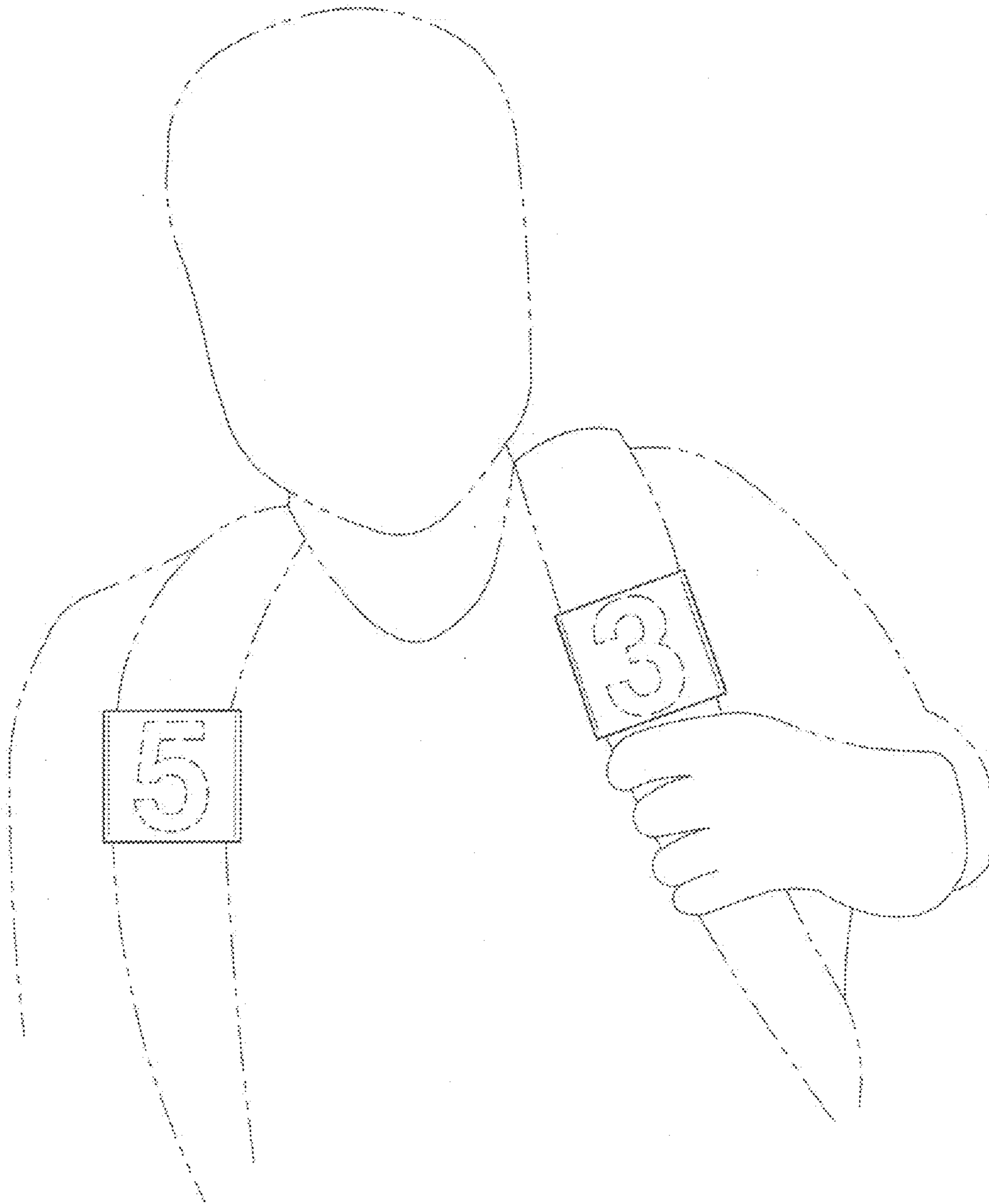

FIG. 7