



US00D677884S

(12) **United States Design Patent**  
**Shyr**

(10) **Patent No.:** **US D677,884 S**  
(45) **Date of Patent:** **\*\* Mar. 19, 2013**

(54) **BASKETBALL BAG**

*Primary Examiner* — Holly Baynham

(76) Inventor: **Michael Shyr**, Hacienda Heights, CA  
(US)

(74) *Attorney, Agent, or Firm* — Clement Cheng

(\*\*) Term: **14 Years**

(57) **CLAIM**

(21) Appl. No.: **29/411,086**

The ornamental design for a basketball bag thereof, as shown and described.

(22) Filed: **Jan. 17, 2012**

(51) **LOC (9) Cl.** ..... **03-01**

**DESCRIPTION**

(52) **U.S. Cl.** ..... **D3/238; D3/234**

(58) **Field of Classification Search** ..... D3/232–234,  
D3/238; 150/100, 103–110, 113–114, 117–119  
See application file for complete search history.

FIG. 1 is a perspective view.

FIG. 2 is a front view.

FIG. 3 is a rear view.

FIG. 4 is a left side view.

FIG. 5 is a right side view.

FIG. 6 is a top view; and,

FIG. 7 is a bottom view.

(56) **References Cited**

**U.S. PATENT DOCUMENTS**

|              |         |        |       |          |
|--------------|---------|--------|-------|----------|
| D318,567 S * | 7/1991  | Smith  | ..... | D3/238   |
| D346,273 S * | 4/1994  | Lucas  | ..... | D3/271.9 |
| D362,960 S * | 10/1995 | Stein  | ..... | D3/226   |
| D469,608 S * | 2/2003  | Nevins | ..... | D3/300   |

The broken lines showing a bag strap and portions of the bag are for the purposes of illustrating environment and forms no part of the claimed design.

\* cited by examiner

**1 Claim, 4 Drawing Sheets**

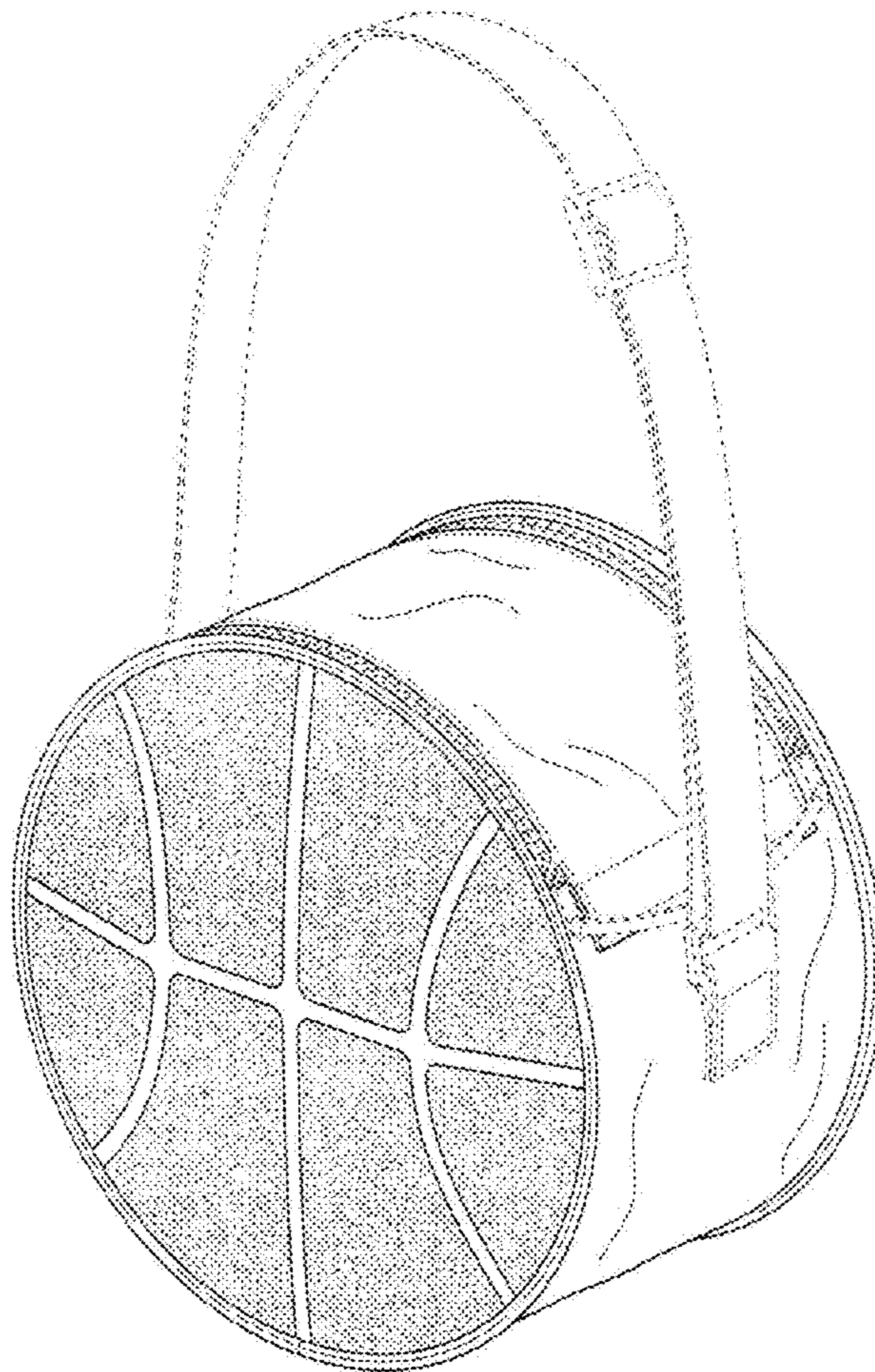

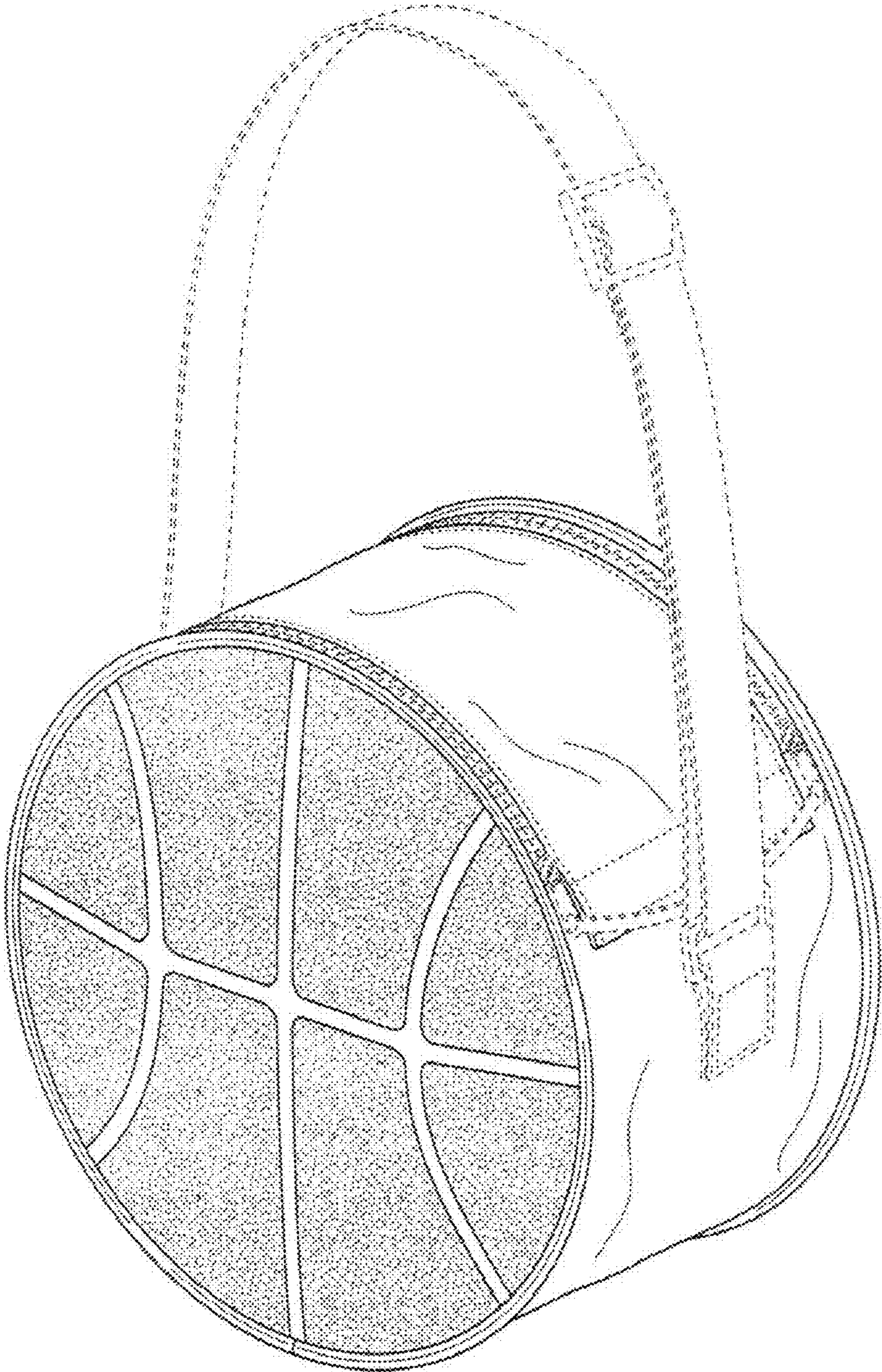

FIG. 1



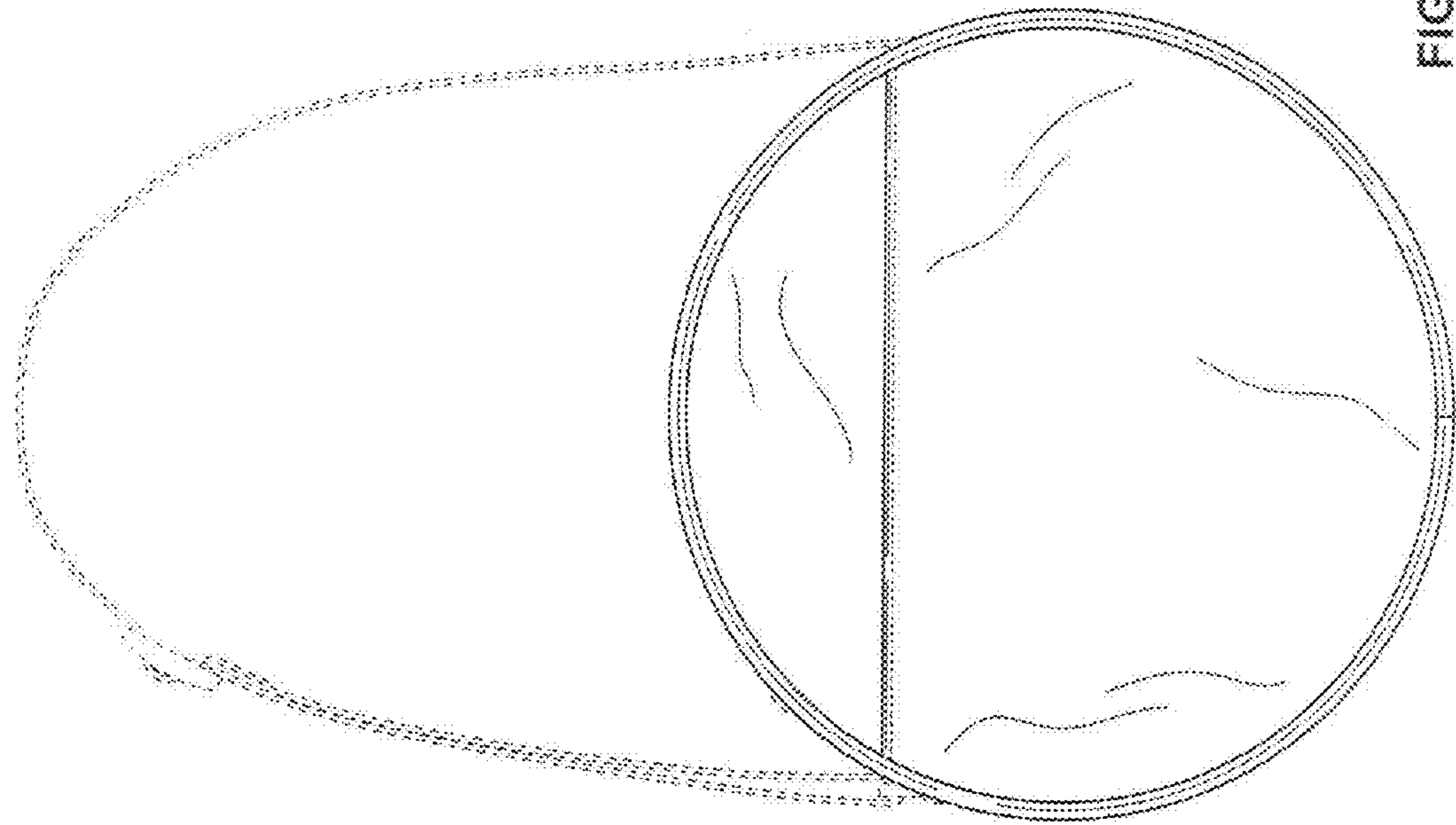

FIG. 3

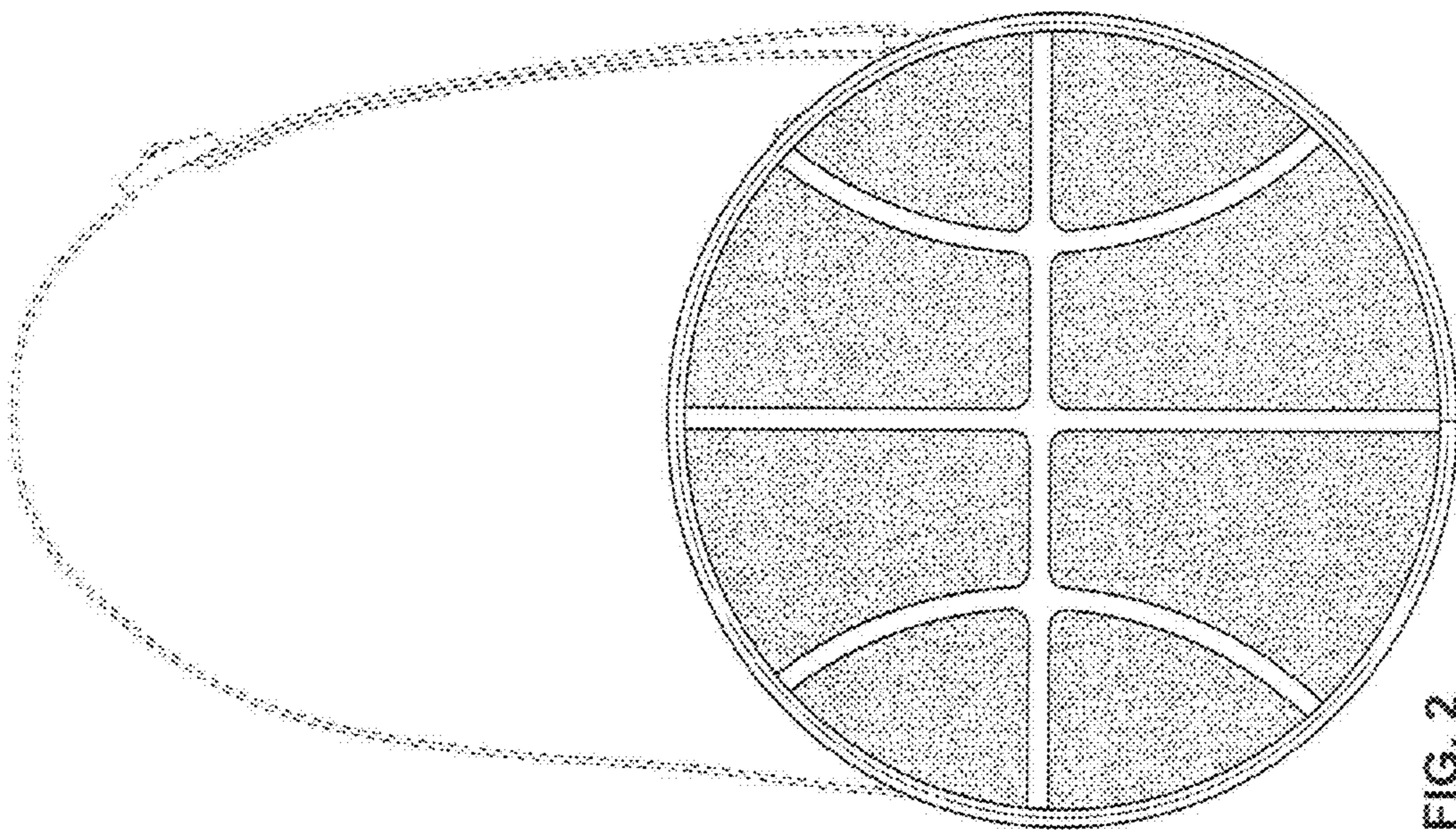

FIG. 2

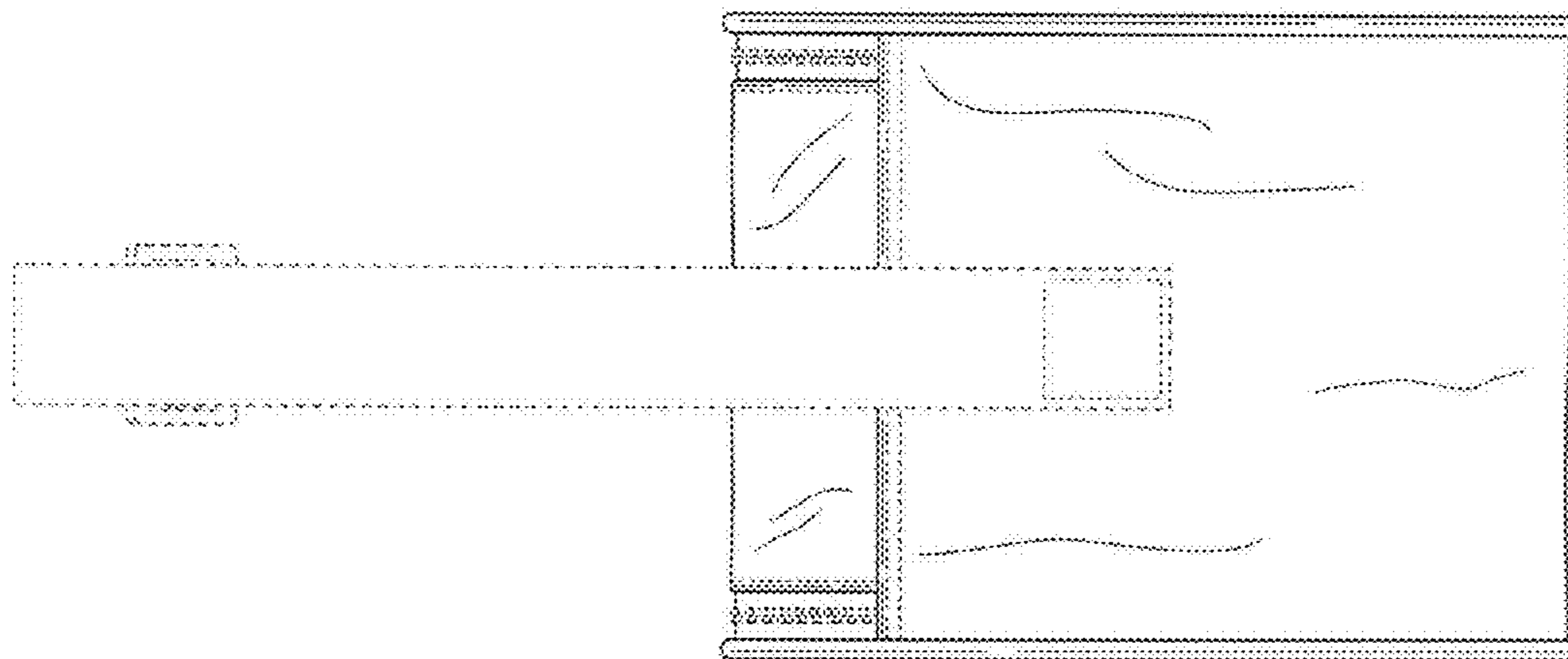

FIG. 5

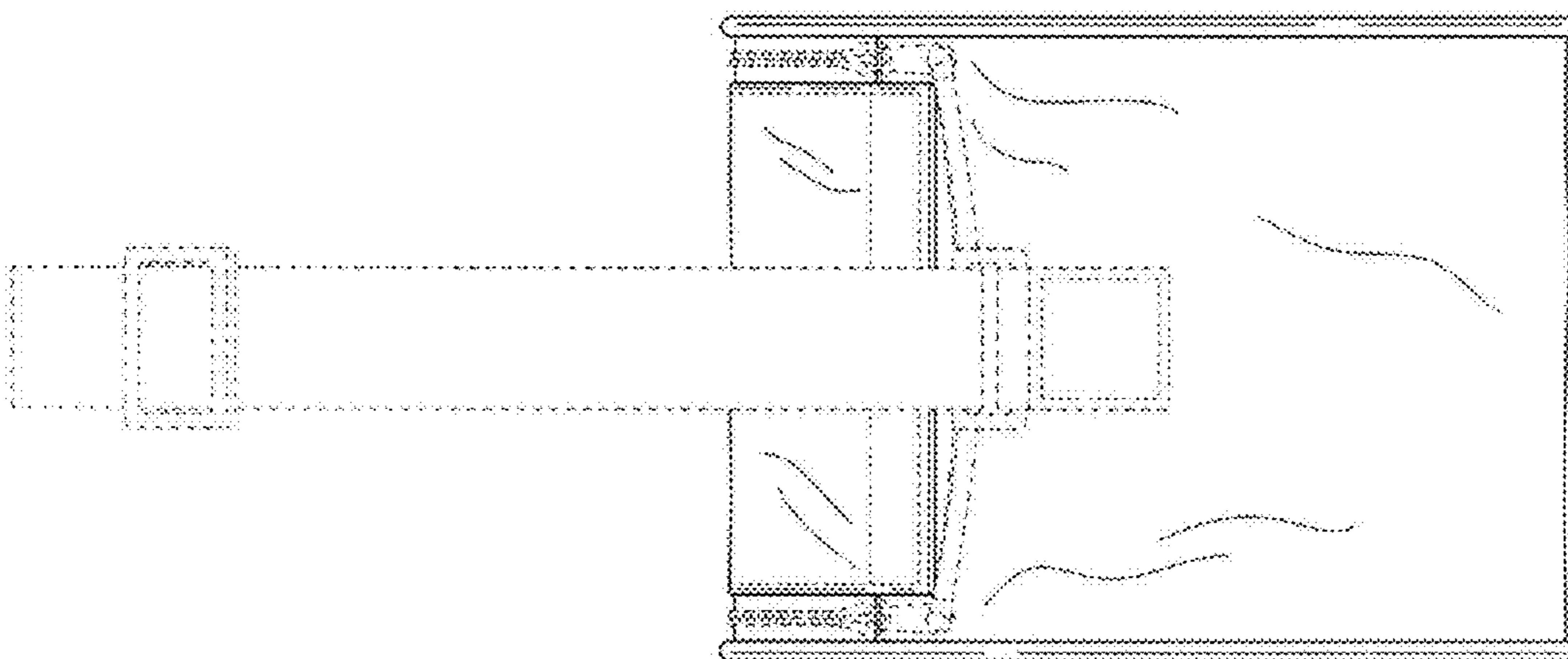

FIG. 4

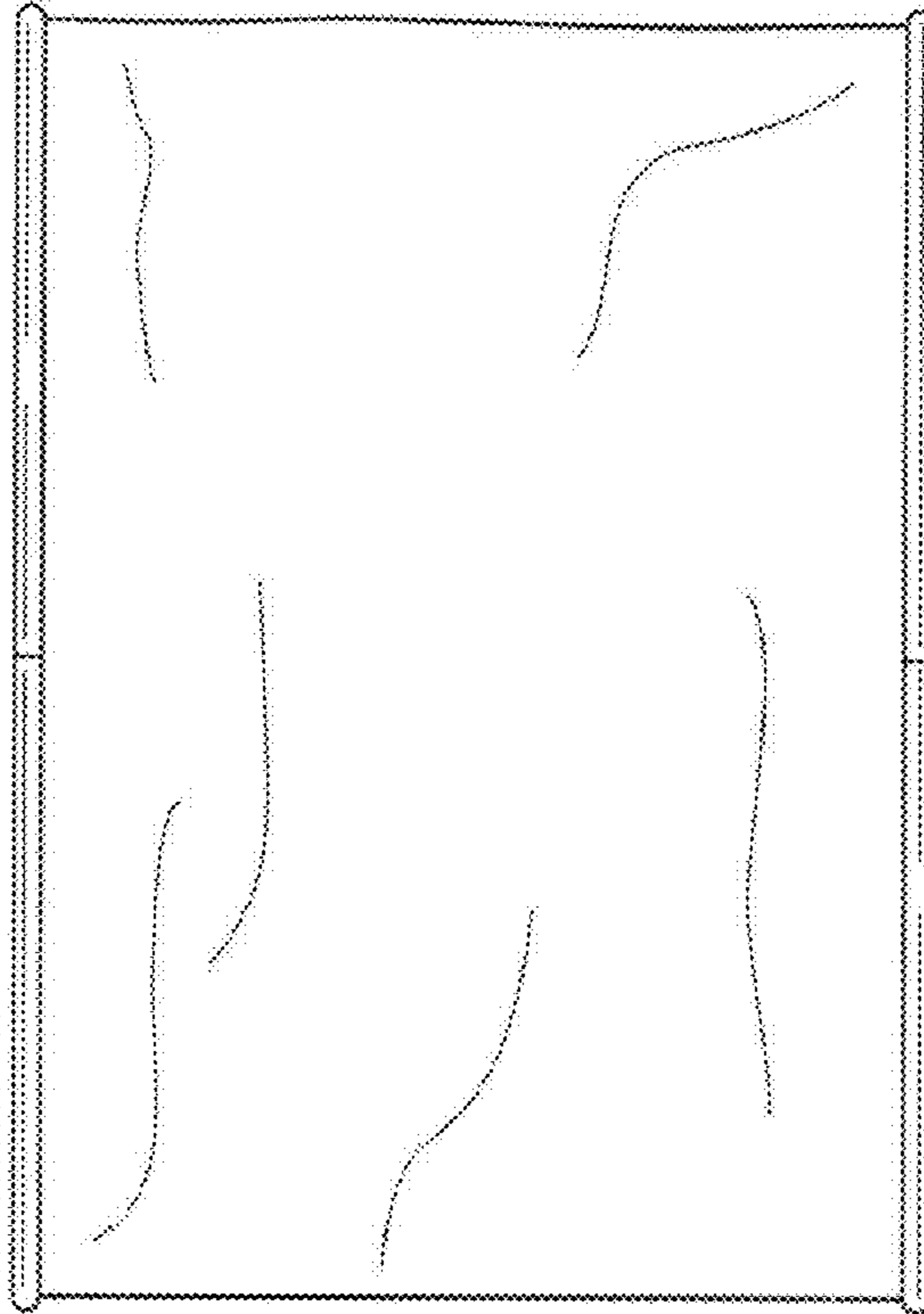

FIG. 7

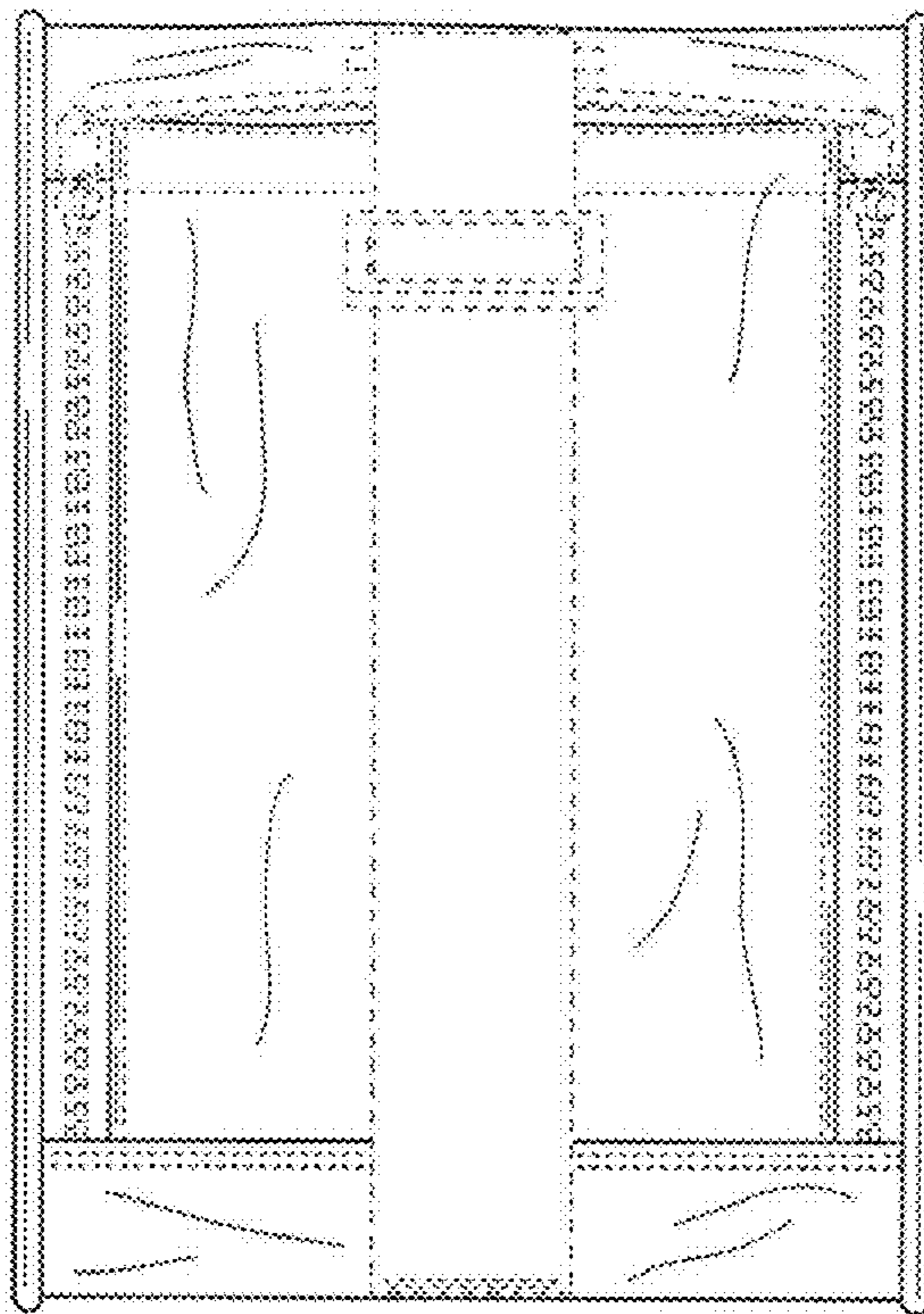

FIG. 6