



US00D677871S

(12) **United States Design Patent**  
**Portzline**

(10) **Patent No.:** **US D677,871 S**  
(45) **Date of Patent:** **\*\* Mar. 19, 2013**

(54) **FOOTWEAR**

D593,743 S \* 6/2009 Belley et al. .... D2/970  
D613,932 S \* 4/2010 Portzline .... D2/970  
D637,385 S \* 5/2011 Spring .... D2/970

(71) Applicant: **Sorel Corporation**, Portland, OR (US)

\* cited by examiner

(72) Inventor: **William Scott Portzline**, Portland, OR (US)

*Primary Examiner* — Robert M Spear

*Assistant Examiner* — Rashida C McCoy

(73) Assignee: **Sorel Corporation**, Portland, OR (US)

(74) *Attorney, Agent, or Firm* — Schwabe, Williamson & Wyatt P.C.

(\*\*) Term: **14 Years**

(21) Appl. No.: **29/435,167**

(57) **CLAIM**

I claim the ornamental design for footwear, as shown and described.

(22) Filed: **Oct. 19, 2012**

(51) **LOC (9) Cl.** ..... **02-04**

(52) **U.S. Cl.** ..... **D2/970; D2/911**

(58) **Field of Classification Search** ..... D2/896,  
D2/900, 902, 909–913, 946, 969, 970, 972–974;  
36/45, 50.1, 77 M, 77 R, 83, 88, 113, 114,  
36/126–181

See application file for complete search history.

**DESCRIPTION**

FIG. 1 is a perspective view of footwear, showing my new design;

FIG. 2 is a left side view thereof;

FIG. 3 is a right side view thereof;

FIG. 4 is a top view thereof;

FIG. 5 is a bottom view thereof;

FIG. 6 is a front view thereof; and,

FIG. 7 is a back view thereof.

The unevenly spaced dashed lines are included for illustrating environmental structure and form no part of the claimed design. The evenly spaced dashed lines represent stitching which also forms no part of the claimed design.

(56) **References Cited**

U.S. PATENT DOCUMENTS

D164,155 S \* 8/1951 Bingham, Jr. .... D2/912  
D199,558 S \* 11/1964 Cohn .... D2/912  
D241,283 S \* 9/1976 Summa .... D2/912  
D269,731 S \* 7/1983 Mattiuzzo .... D2/912  
D481,863 S \* 11/2003 Belley et al. .... D2/970  
D585,636 S \* 2/2009 Earle .... D2/970

**1 Claim, 7 Drawing Sheets**

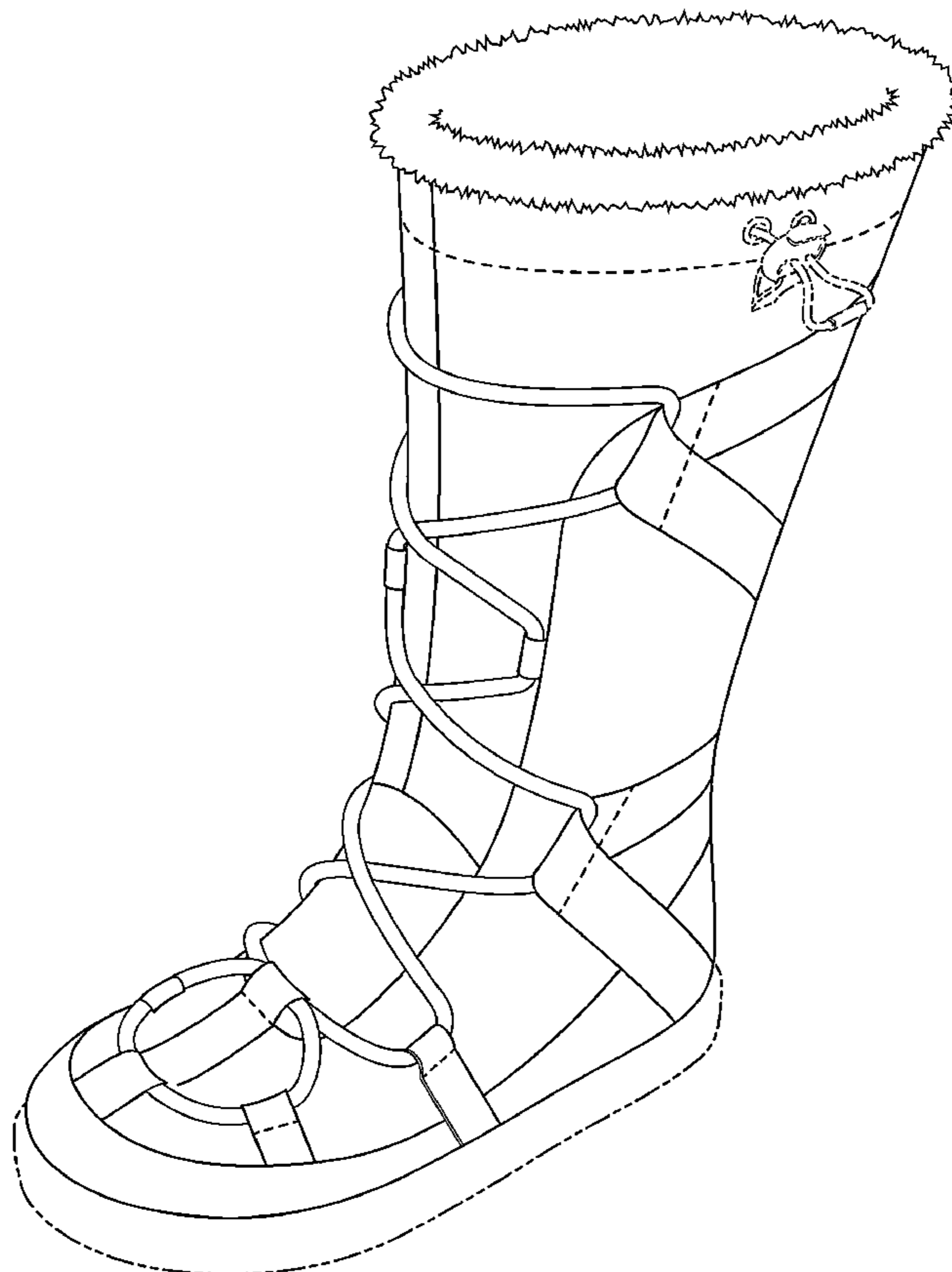
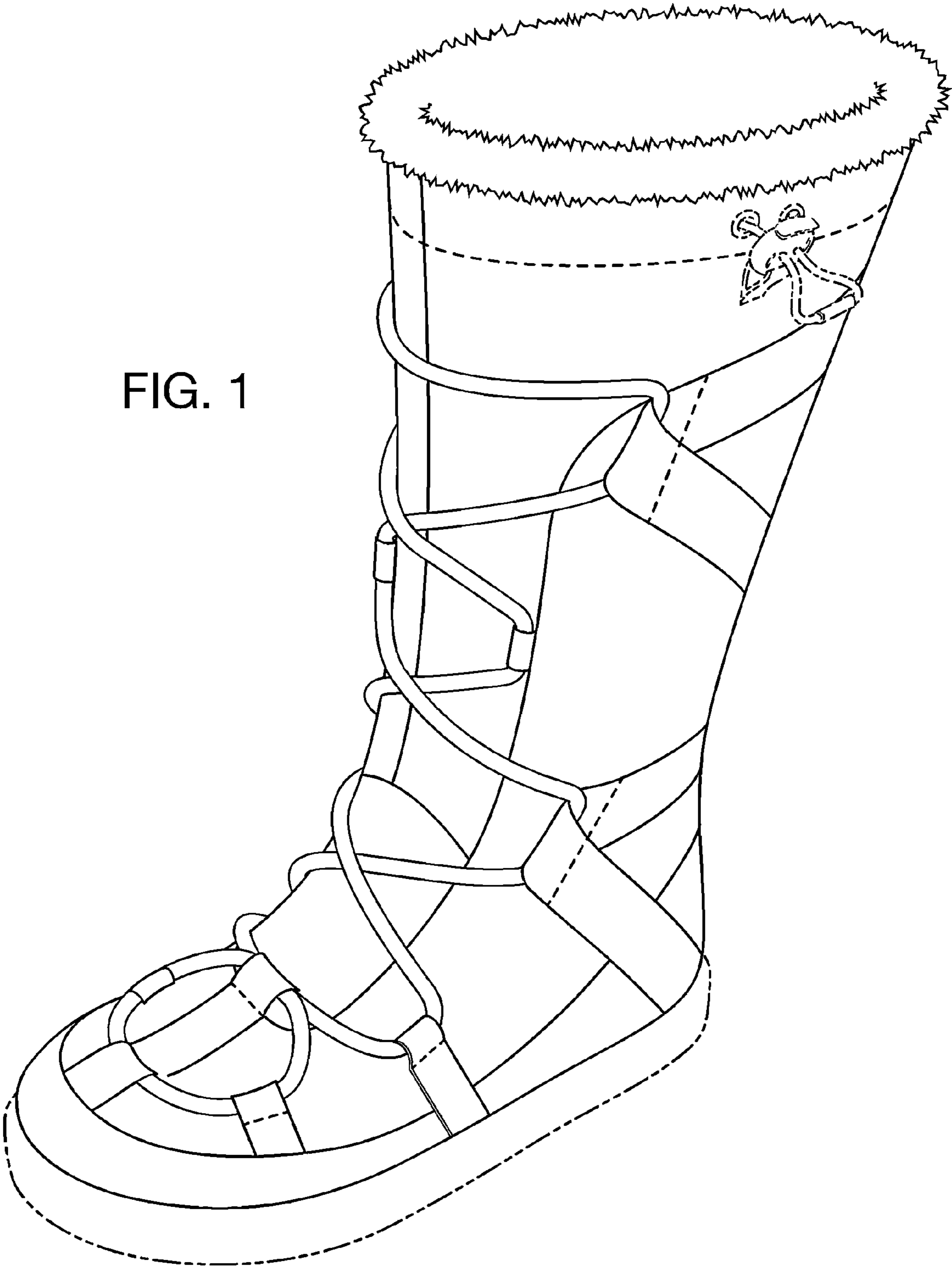

FIG. 1



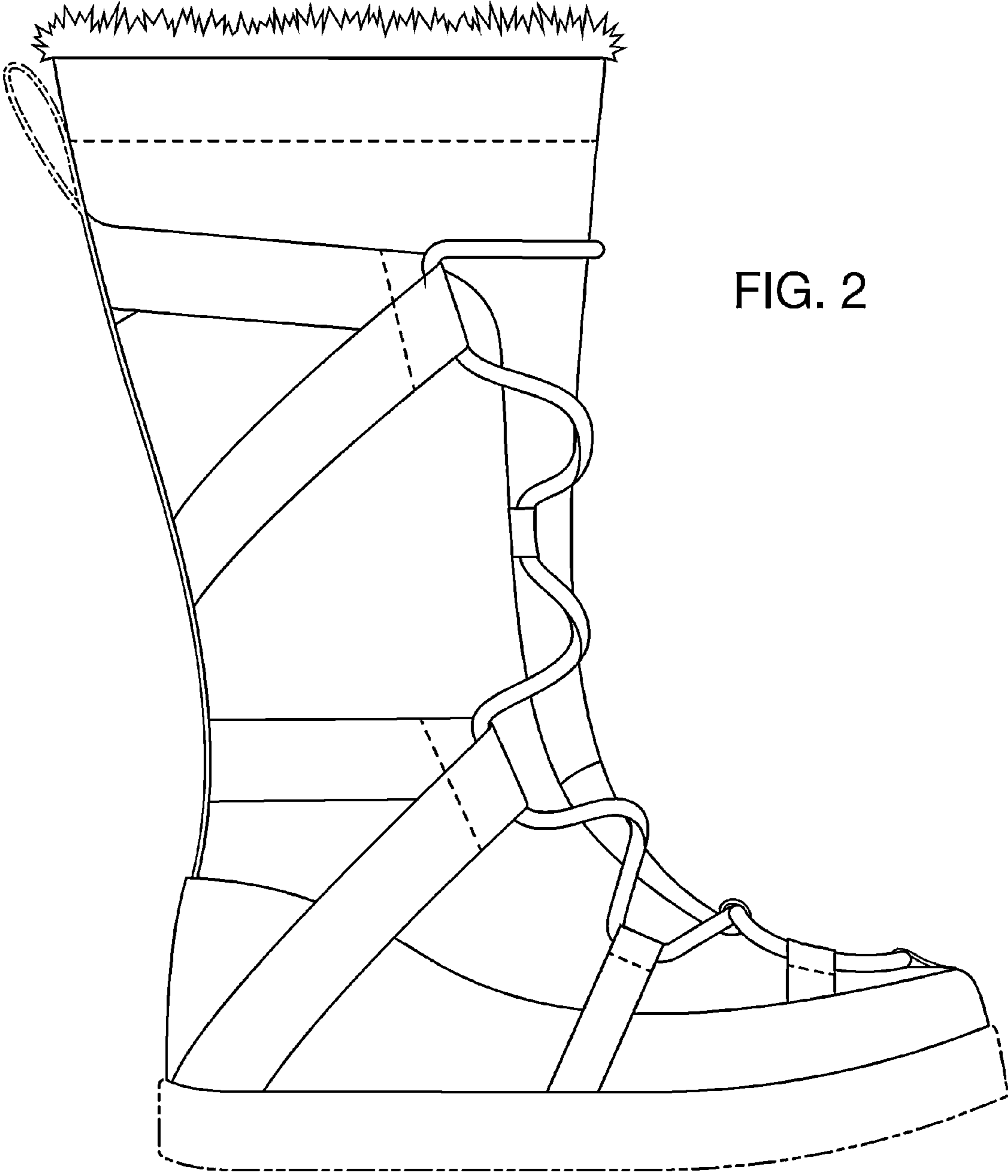

FIG. 2

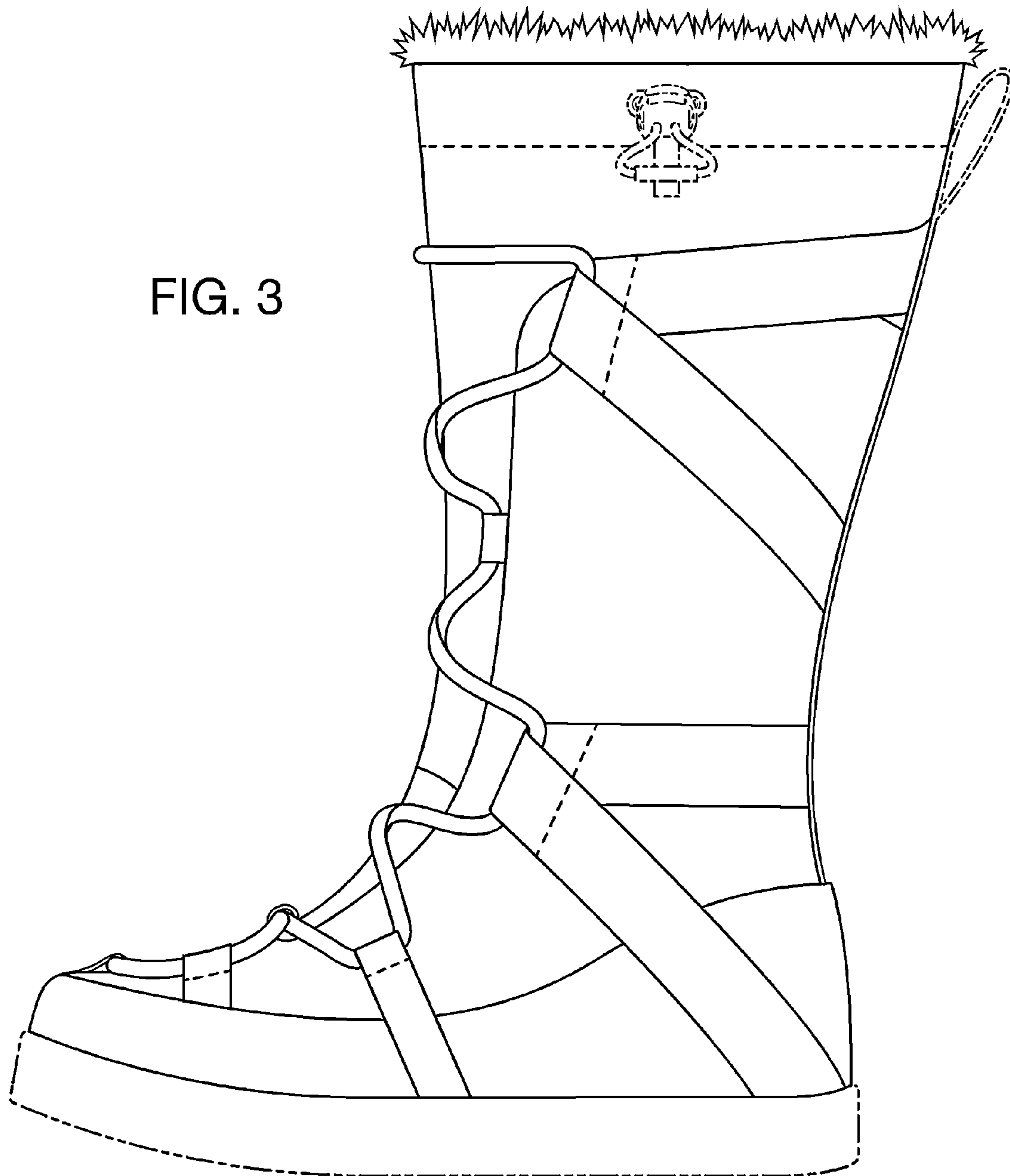

FIG. 3

FIG. 4

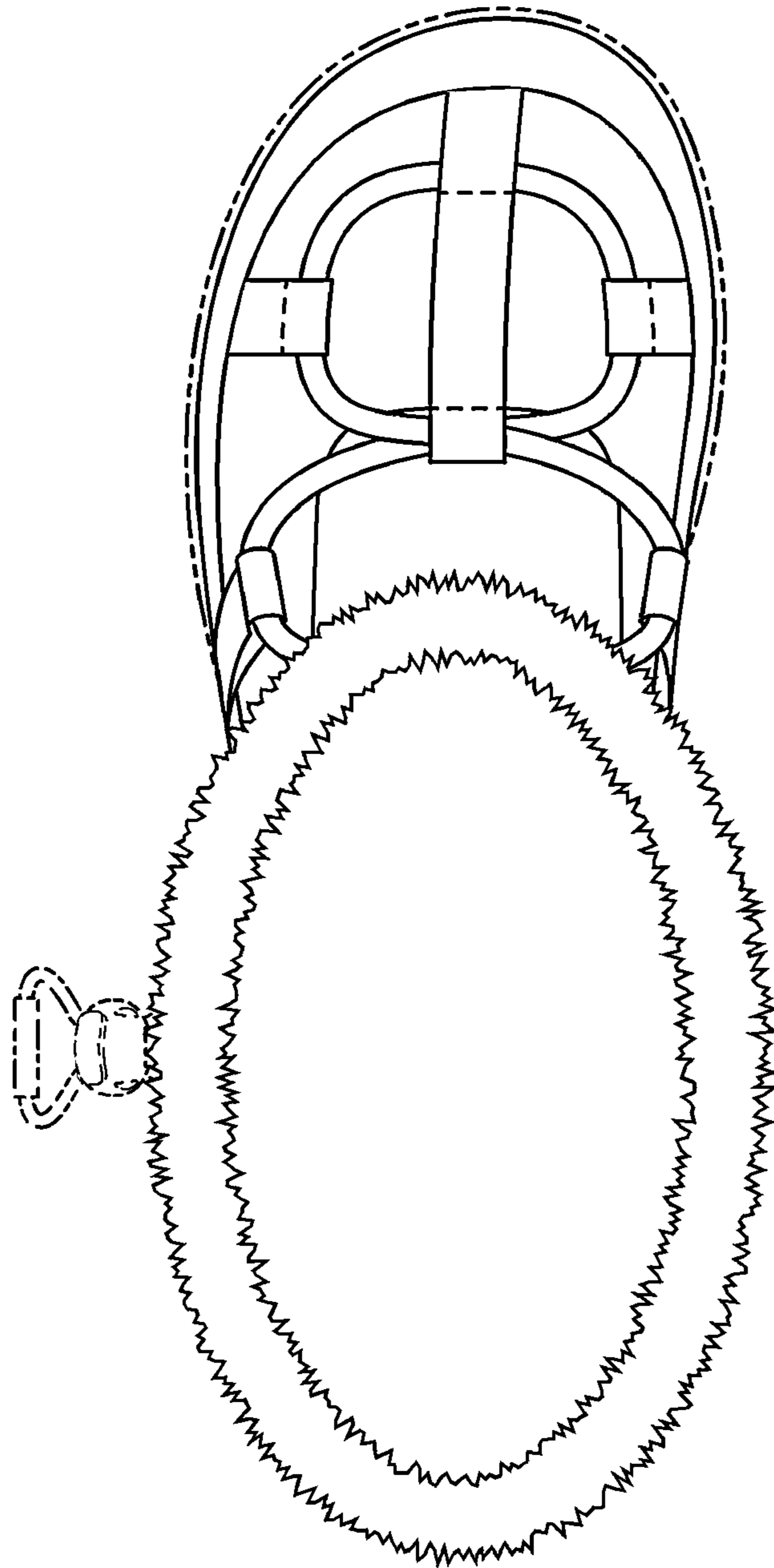
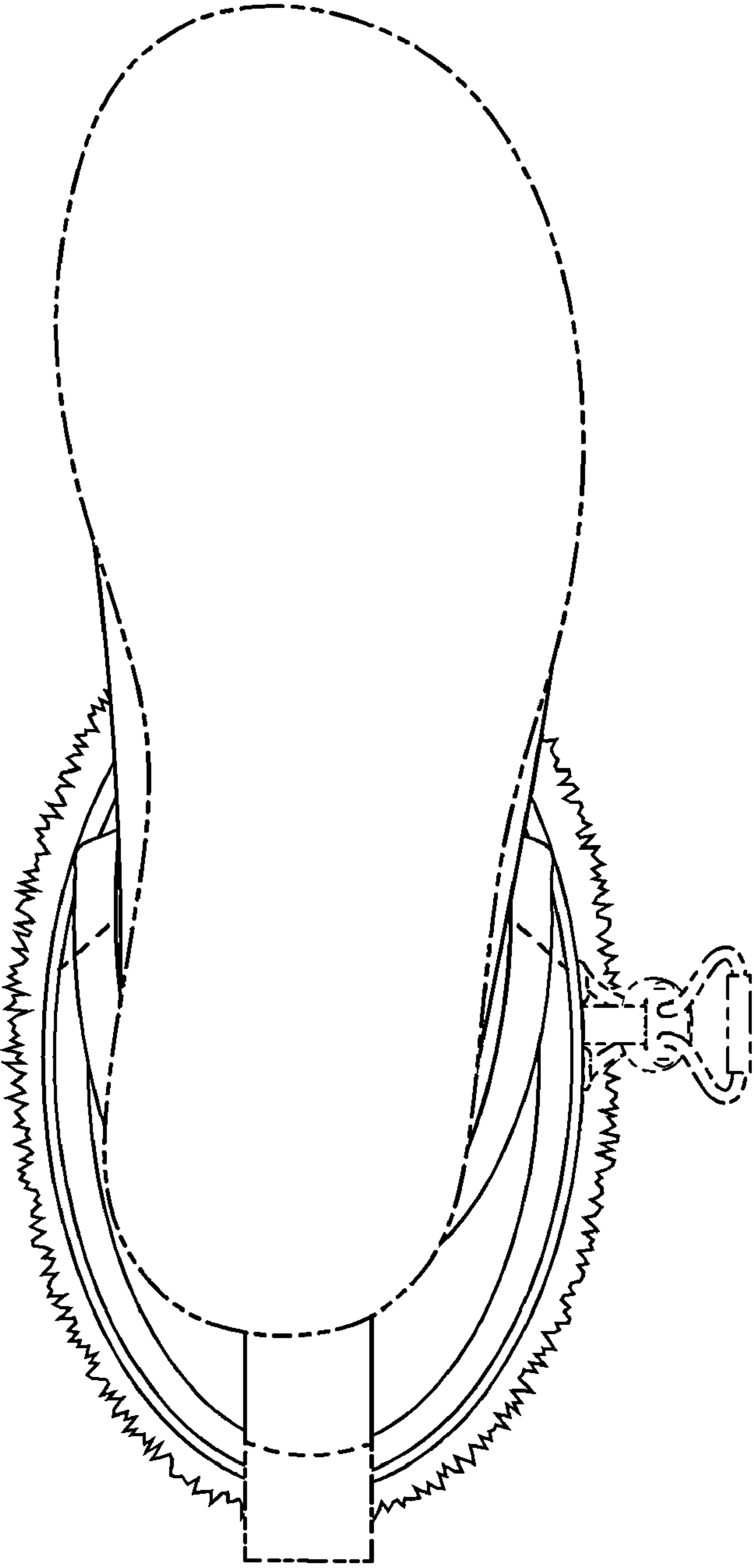

FIG. 5





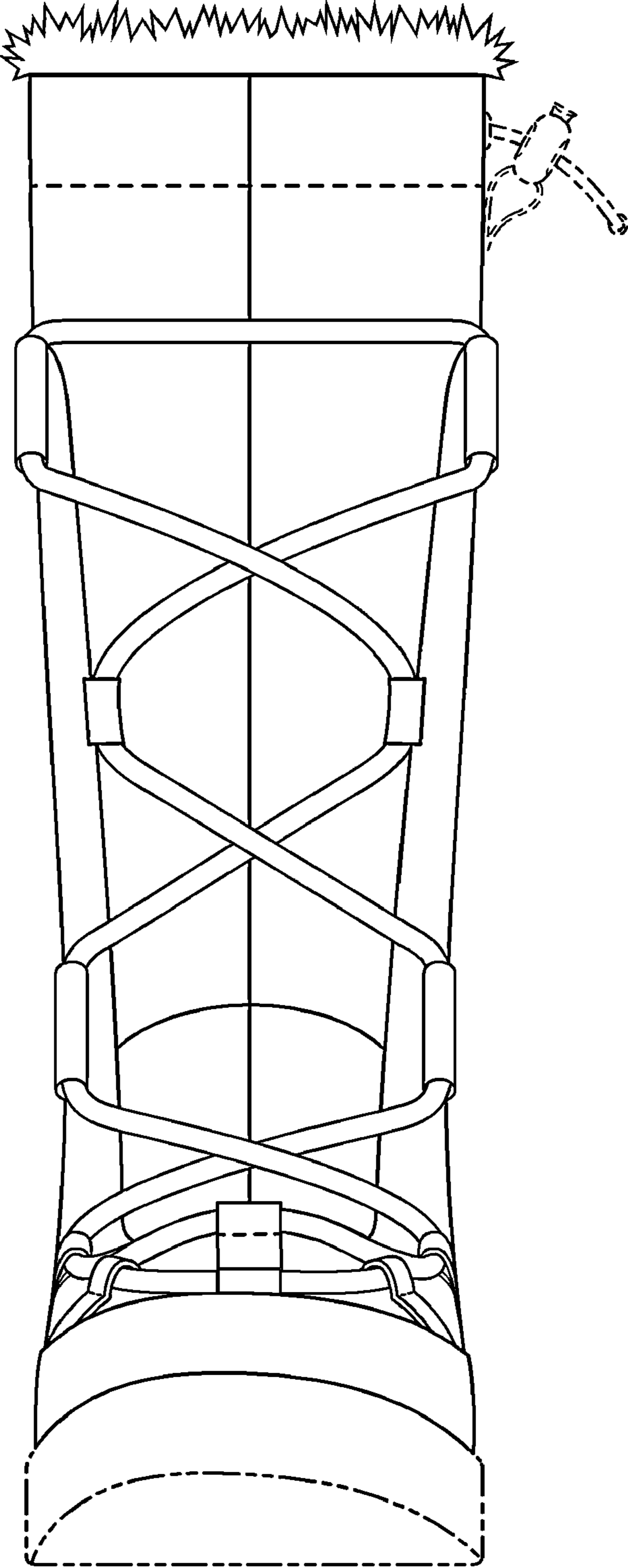

FIG. 6

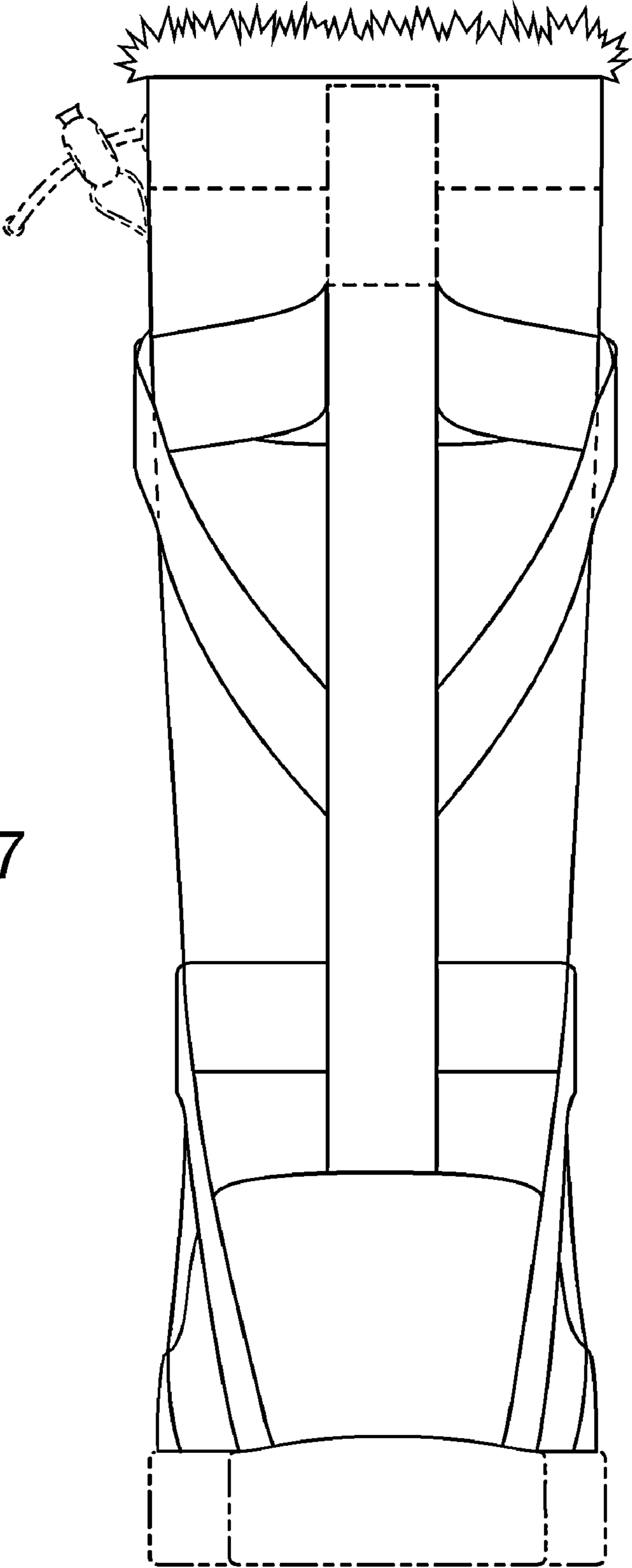

FIG. 7