



US00D677862S

(12) **United States Design Patent**
Van Zyll De Jong et al.

(10) **Patent No.:** **US D677,862 S**
(45) **Date of Patent:** **** Mar. 19, 2013**

(54) **ARTICLE OF FOOTWEAR**

(75) Inventors: **Damian Van Zyll De Jong**, Vancouver (CA); **Matthew Philip Dorrington Penner**, Vancouver (CA)

(73) Assignee: **Native Shoes, Ltd.**, Central, Hong Kong (CN)

(**) Term: **14 Years**

(21) Appl. No.: **29/430,765**

(22) Filed: **Aug. 29, 2012**

(51) **LOC (9) Cl.** **02-04**

(52) **U.S. Cl.** **D2/896; D2/942**

(58) **Field of Classification Search** D2/896,
D2/898, 900, 903, 919-923, 942, 952, 969;
36/45, 11.5, 8.1, 77 M, 77 R, 83, 7
See application file for complete search history.

(56) **References Cited**

U.S. PATENT DOCUMENTS

D112,344 S *	11/1938	Lutz	D2/945
D140,573 S *	3/1945	Sandler	D2/943
D412,776 S *	8/1999	Biedermann	D2/919
D437,474 S *	2/2001	Agnew et al.	D2/908
D548,940 S *	8/2007	Hulbert	D2/969
D574,587 S *	8/2008	McDowell	D2/969
D581,644 S *	12/2008	Roy	D2/969
D602,243 S *	10/2009	Bradford	D2/971
D650,975 S *	12/2011	Menghi	D2/939

* cited by examiner

Primary Examiner — Robert M Spear

Assistant Examiner — Rashida C McCoy

(74) *Attorney, Agent, or Firm* — Ingrassia Fisher & Lorenz, P.C.

(57) **CLAIM**

The ornamental design for an article of footwear, as shown and described.

DESCRIPTION

FIG. 1 is a top perspective view of an article of footwear, showing the claimed design;

FIG. 2 is an outer side view of the article of footwear shown in FIG. 1;

FIG. 3 is an inner side view of the article of footwear shown in FIG. 1;

FIG. 4 is a top view of the article of footwear shown in FIG. 1;

FIG. 5 is a rear view of the article of footwear shown in FIG. 1;

FIG. 6 is a front view of the article of footwear shown in FIG. 1; and,

FIG. 7 is a bottom view of the article of footwear shown in FIG. 1.

The broken lines shown in the figures represent portions of the article of footwear that form no part of the claimed design.

1 Claim, 4 Drawing Sheets

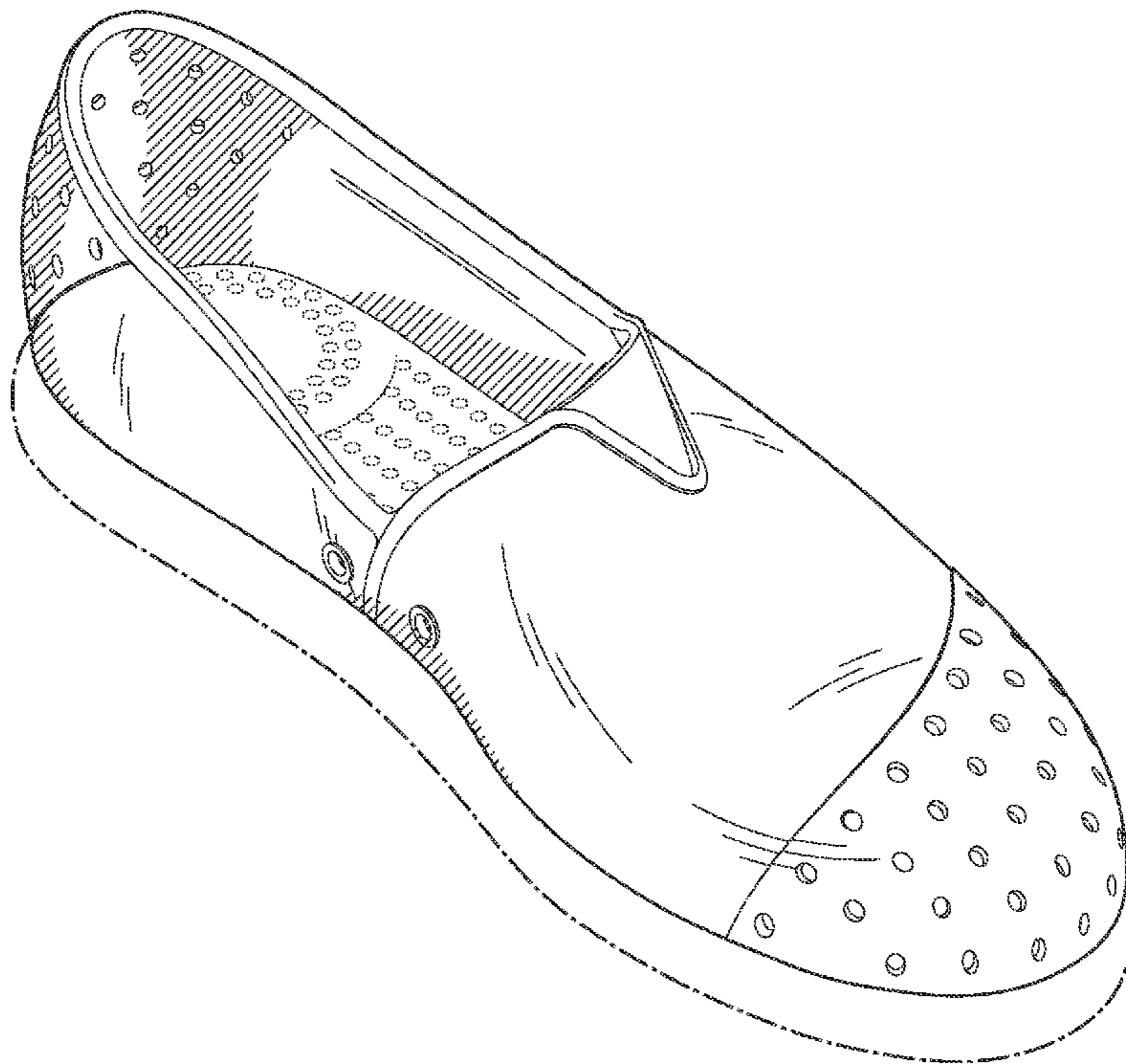

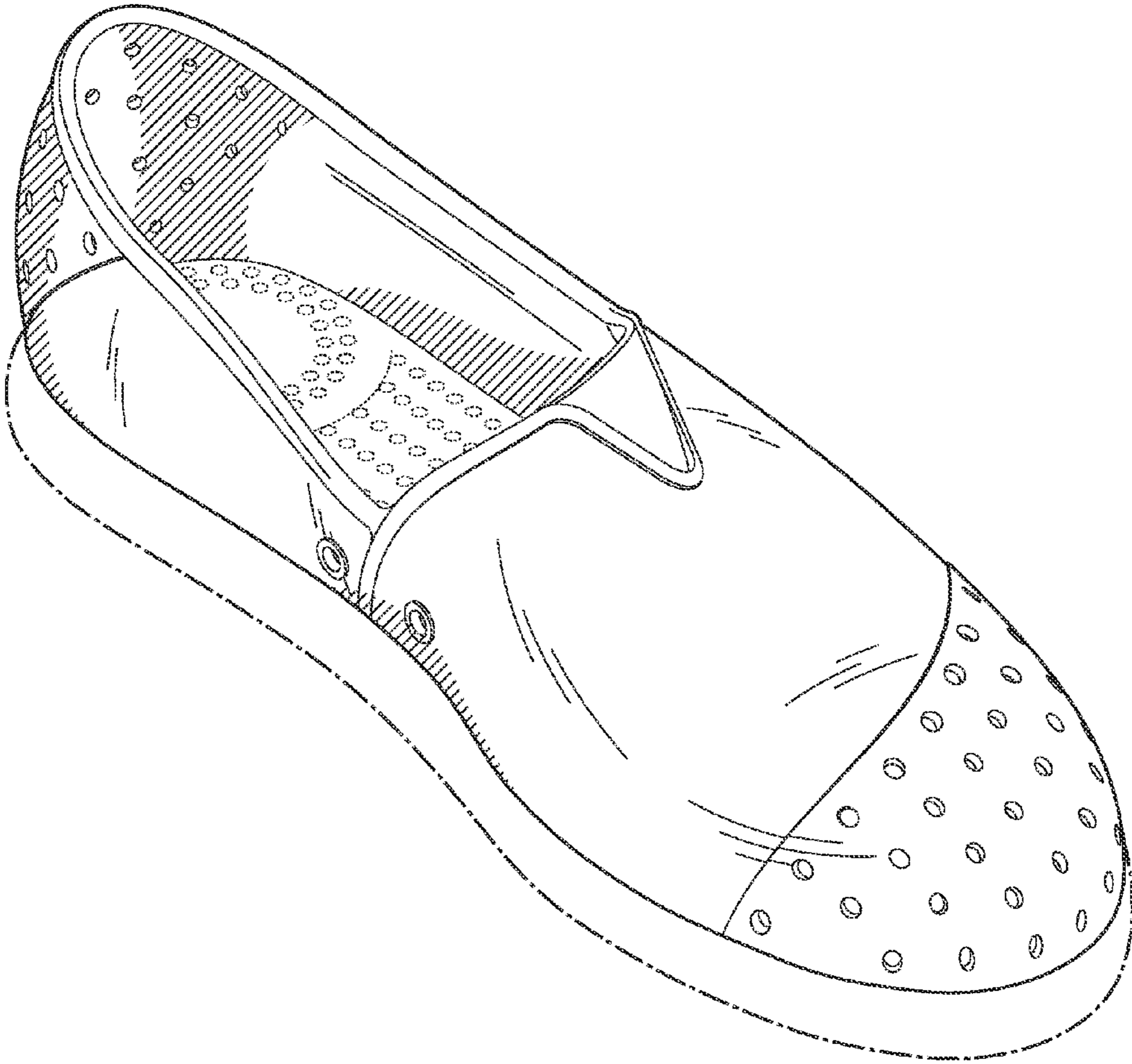

FIG. 1

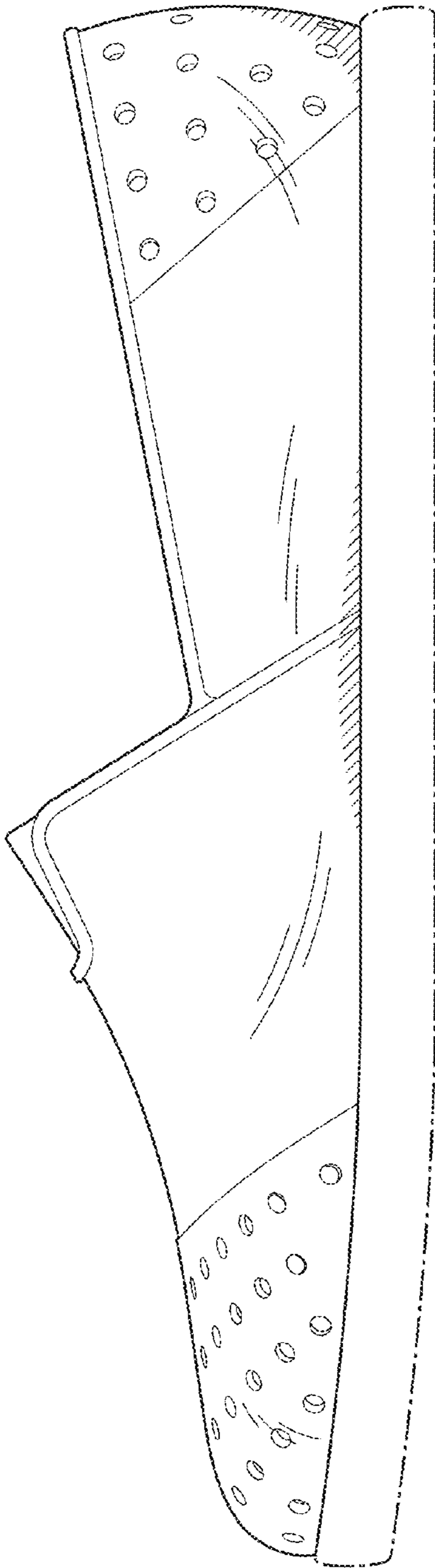

FIG. 2

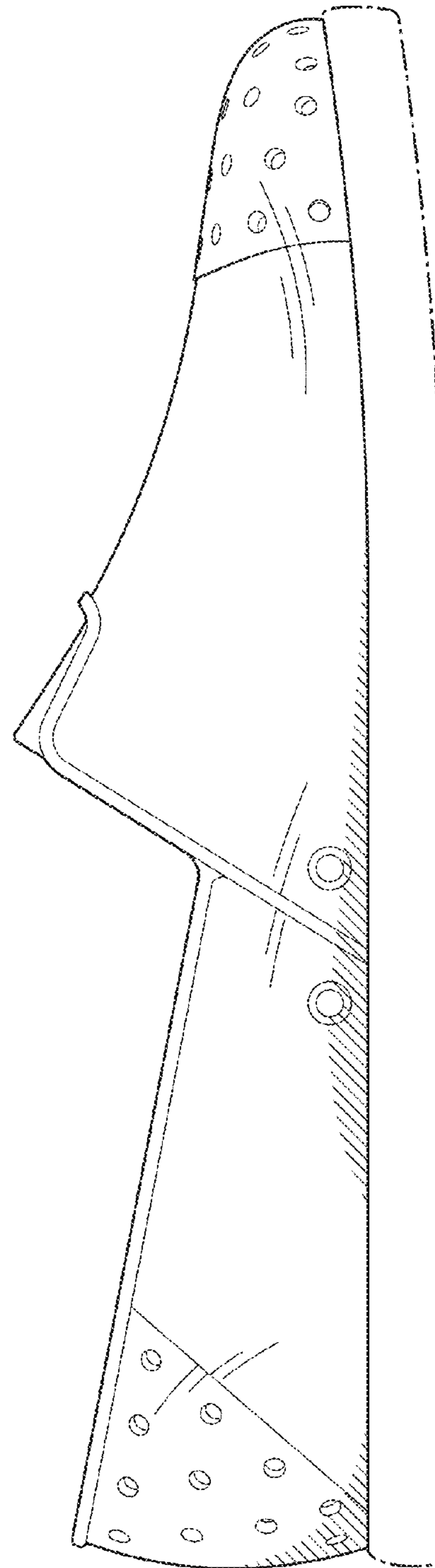

FIG. 3

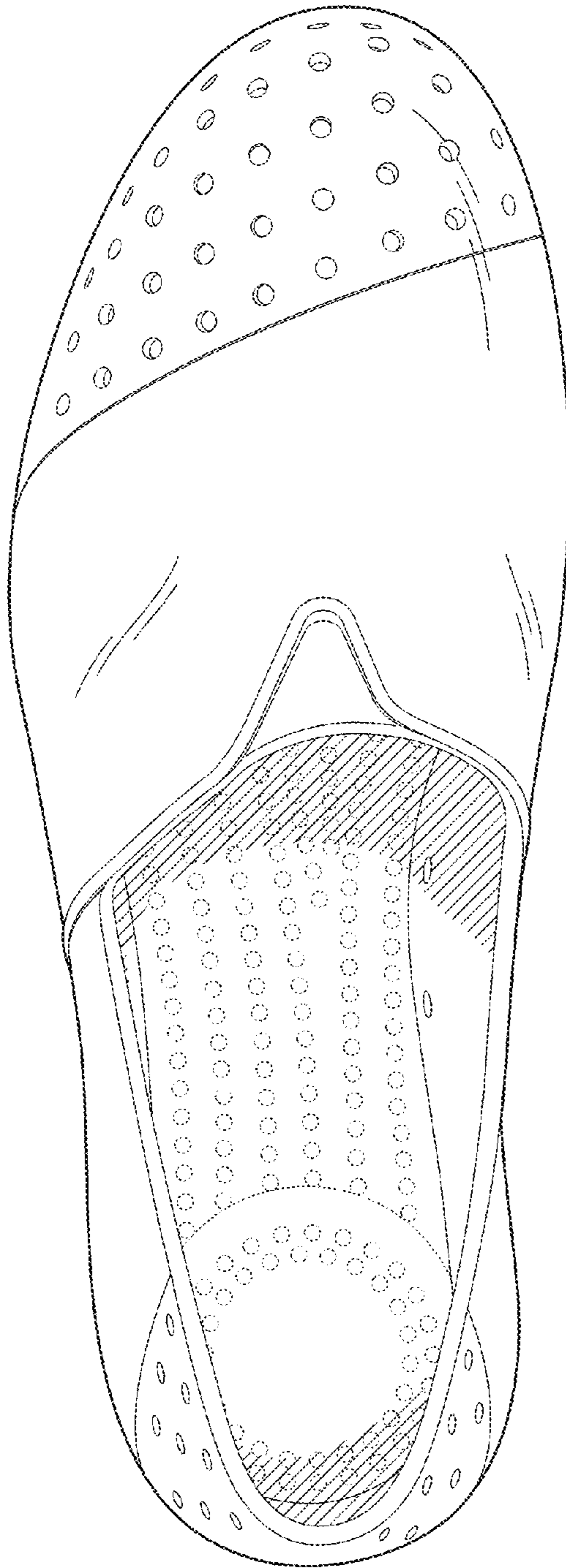

FIG. 4

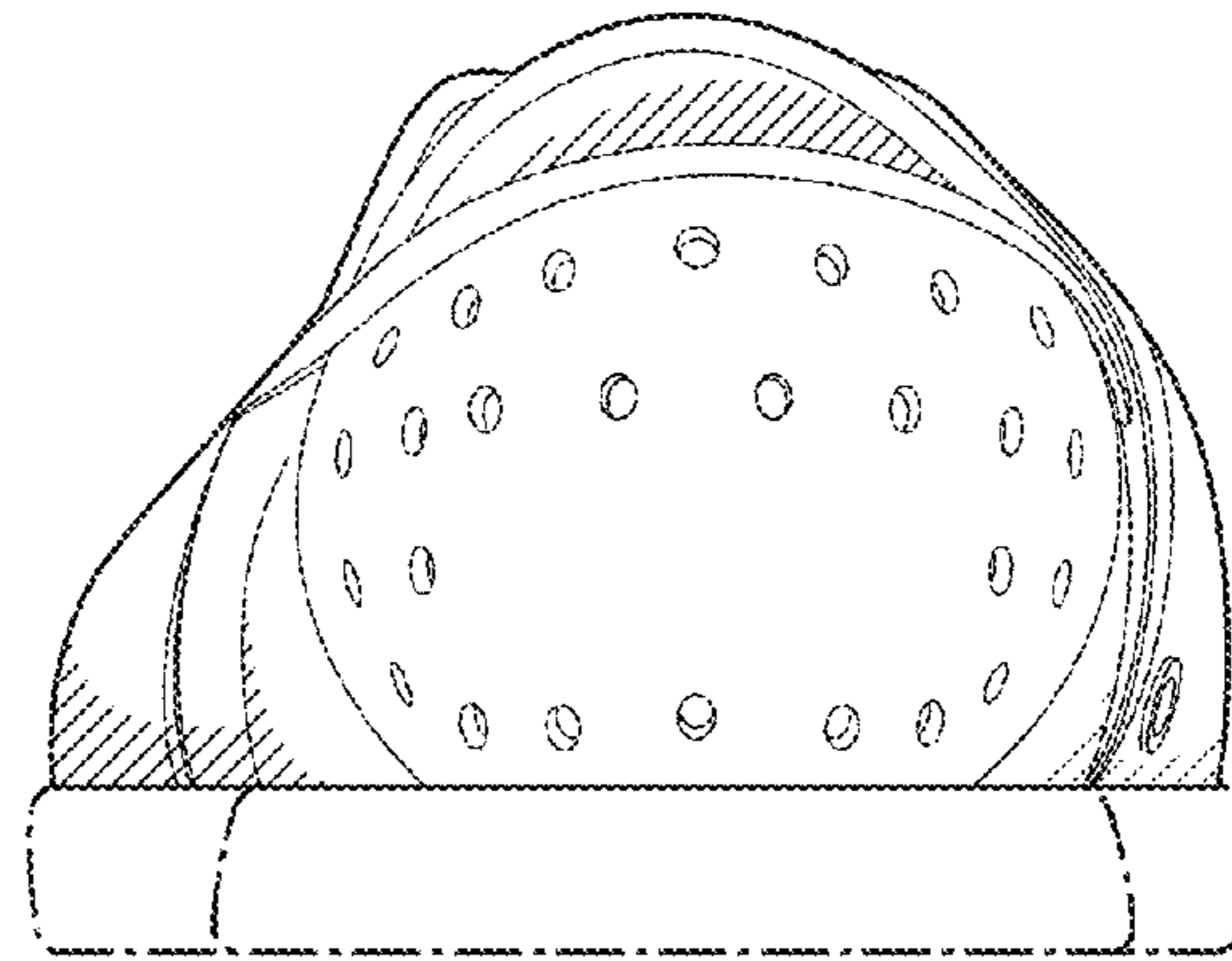

FIG. 5

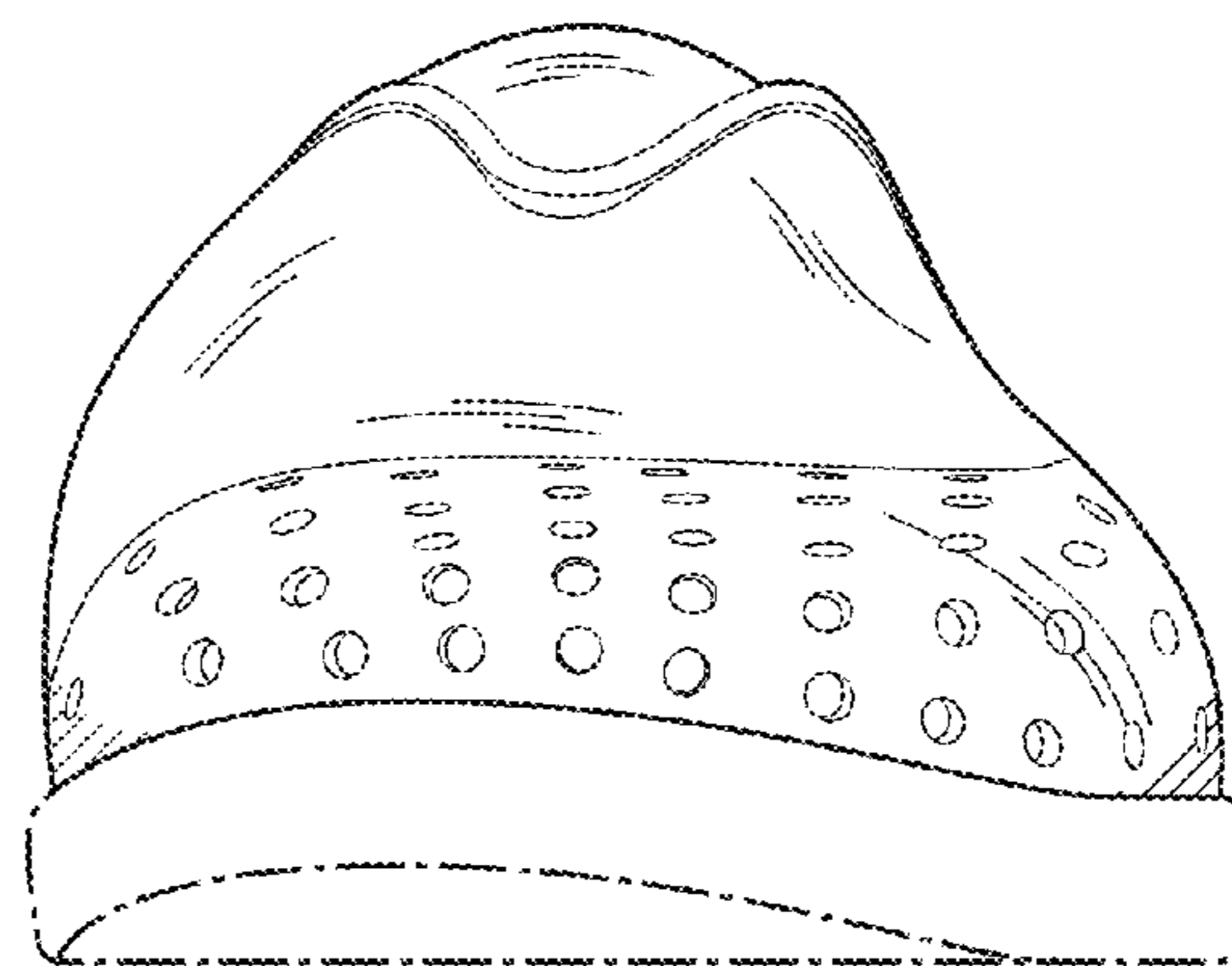

FIG. 6

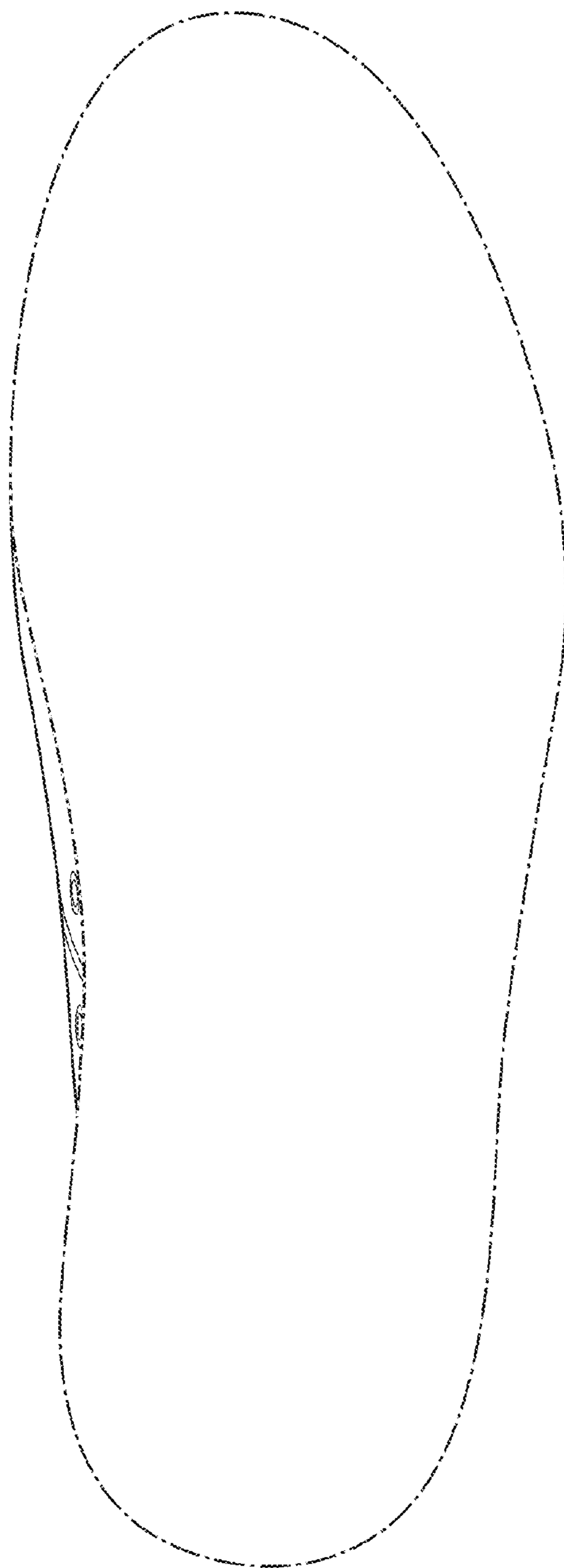

FIG. 7