



US00D677782S

(12) **United States Design Patent**
D'Souza et al.

(10) **Patent No.:** **US D677,782 S**
(45) **Date of Patent:** **** Mar. 12, 2013**

(54) **FRAME FOR RESPIRATORY MASK**

(75) Inventors: **Errol Savio Alex D'Souza**, Hornsby Heights (AU); **David James Lockwood**, Seaford (AU); **Stuart Norris Plascott**, Macquarie Park (AU); **Jamie Graeme Wehbeh**, Mosman (AU)

(73) Assignee: **ResMed Limited**, Bella Vista (AU)

(**) Term: **14 Years**

(21) Appl. No.: **29/371,611**

(22) Filed: **May 19, 2011**

Related U.S. Application Data

(63) Continuation of application No. 29/347,441, filed on Jan. 8, 2010, now Pat. No. Des. 639,932.

(51) **LOC (9) Cl.** **29-02**

(52) **U.S. Cl.** **D24/110.4; D24/110.1**

(58) **Field of Classification Search** D24/110.1, D24/110.2, 110.3, 110.4; 128/206.21–206.29, 128/207.11–207.18

See application file for complete search history.

(56) **References Cited**

U.S. PATENT DOCUMENTS

D430,663	S	*	9/2000	Smart	D24/110.4
D493,885	S		8/2004	Raje et al.		
D519,206	S	*	4/2006	Jones et al.	D24/110.1
D519,207	S		4/2006	Raje et al.		
D533,269	S	*	12/2006	McAuley et al.	D24/110.6
D542,407	S	*	5/2007	Stallard et al.	D24/110.1
D558,334	S		12/2007	Stallard et al.		

D569,502	S	*	5/2008	Abel et al.	D24/110.6
D586,458	S		2/2009	Kooij et al.		
D635,661	S	*	4/2011	Stallard et al.	D24/110.1
D637,711	S	*	5/2011	Facer et al.	D24/110
D639,932	S	*	6/2011	D'Souza et al.	D24/110.1
D652,909	S	*	1/2012	Smart et al.	D24/110.1

OTHER PUBLICATIONS

D'Souza et al., Parent U.S. Appl. No. 29/347,441, filed Jan. 8, 2010.

* cited by examiner

Primary Examiner — Richard E Chilcot

(74) *Attorney, Agent, or Firm* — Nixon & Vanderhye P.C.

(57) **CLAIM**

The ornamental design for a frame for respiratory mask, as shown and described.

DESCRIPTION

FIG. 1 is a front perspective view of a frame for a respiratory mask according to our new ornamental design; FIG. 2 is a front view thereof; FIG. 3 is a rear view thereof; FIG. 4 is a top view thereof; FIG. 5 is a bottom side view thereof; FIG. 6 is a left side view thereof; FIG. 7 is a right side view thereof; and, FIG. 8 is a rear perspective view thereof. Where included, broken lines showing environment or structure are for illustrative purposes only and form no part of the claimed design.

1 Claim, 7 Drawing Sheets

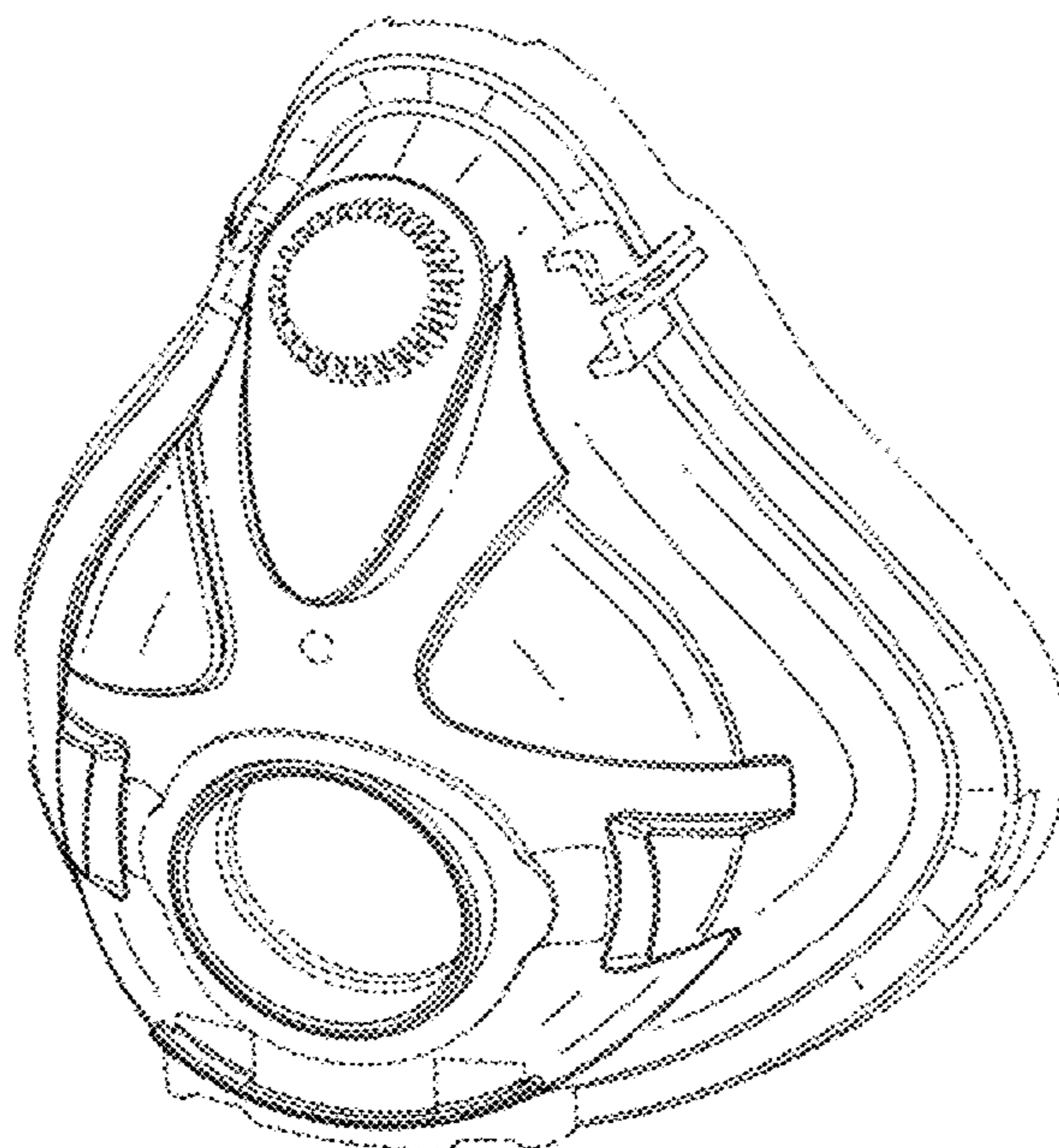

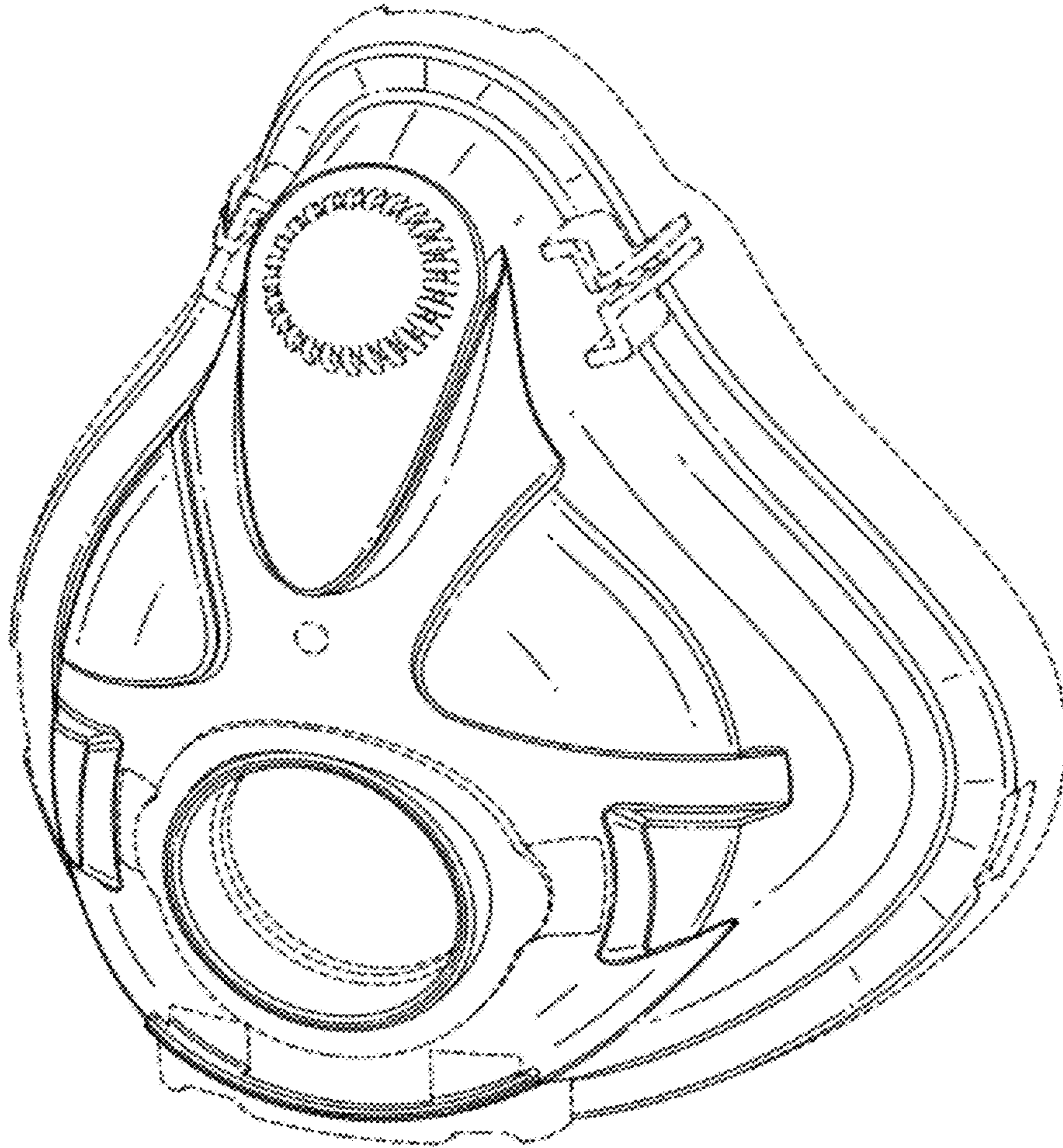

Fig. 1

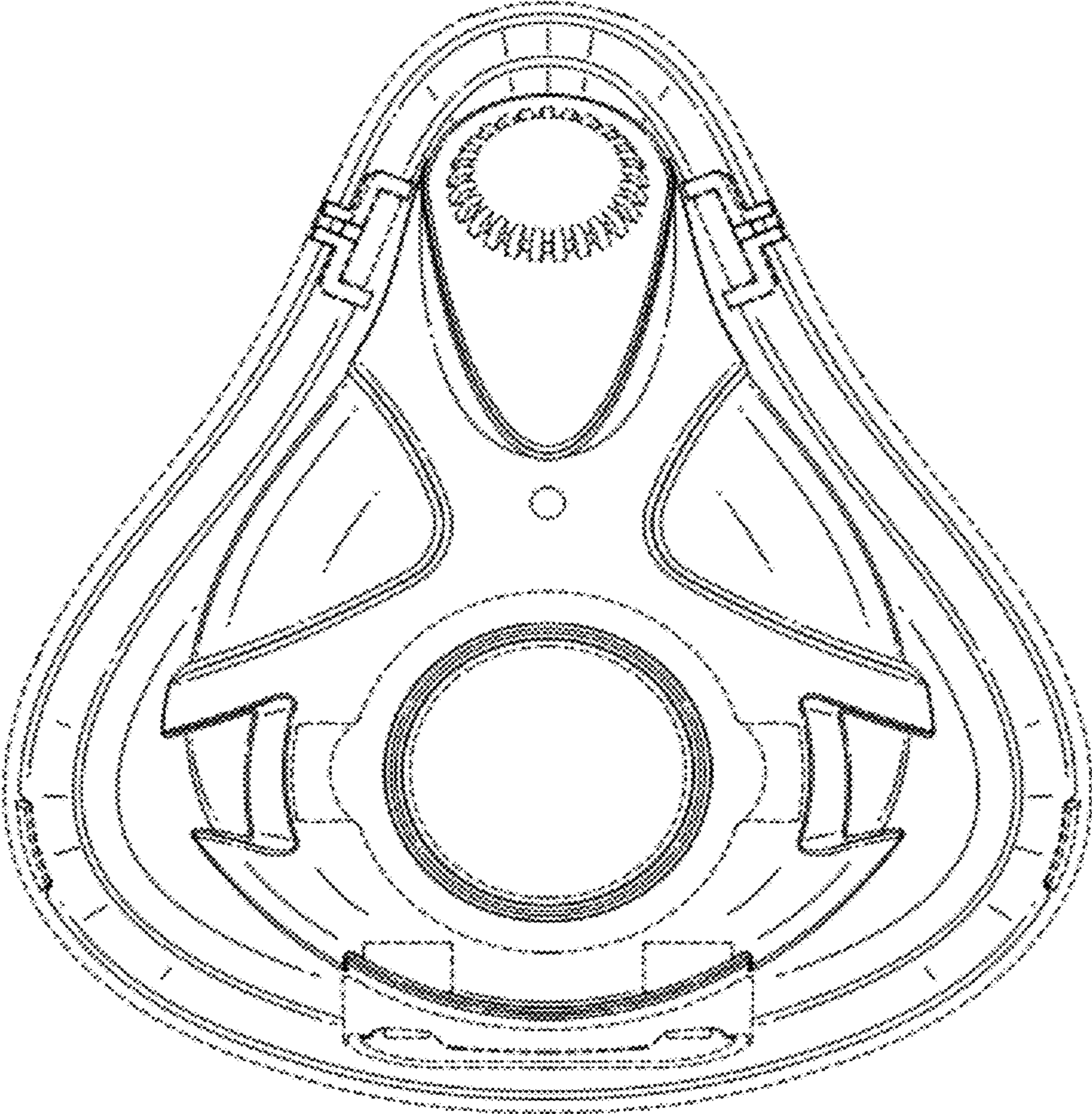

Fig. 2

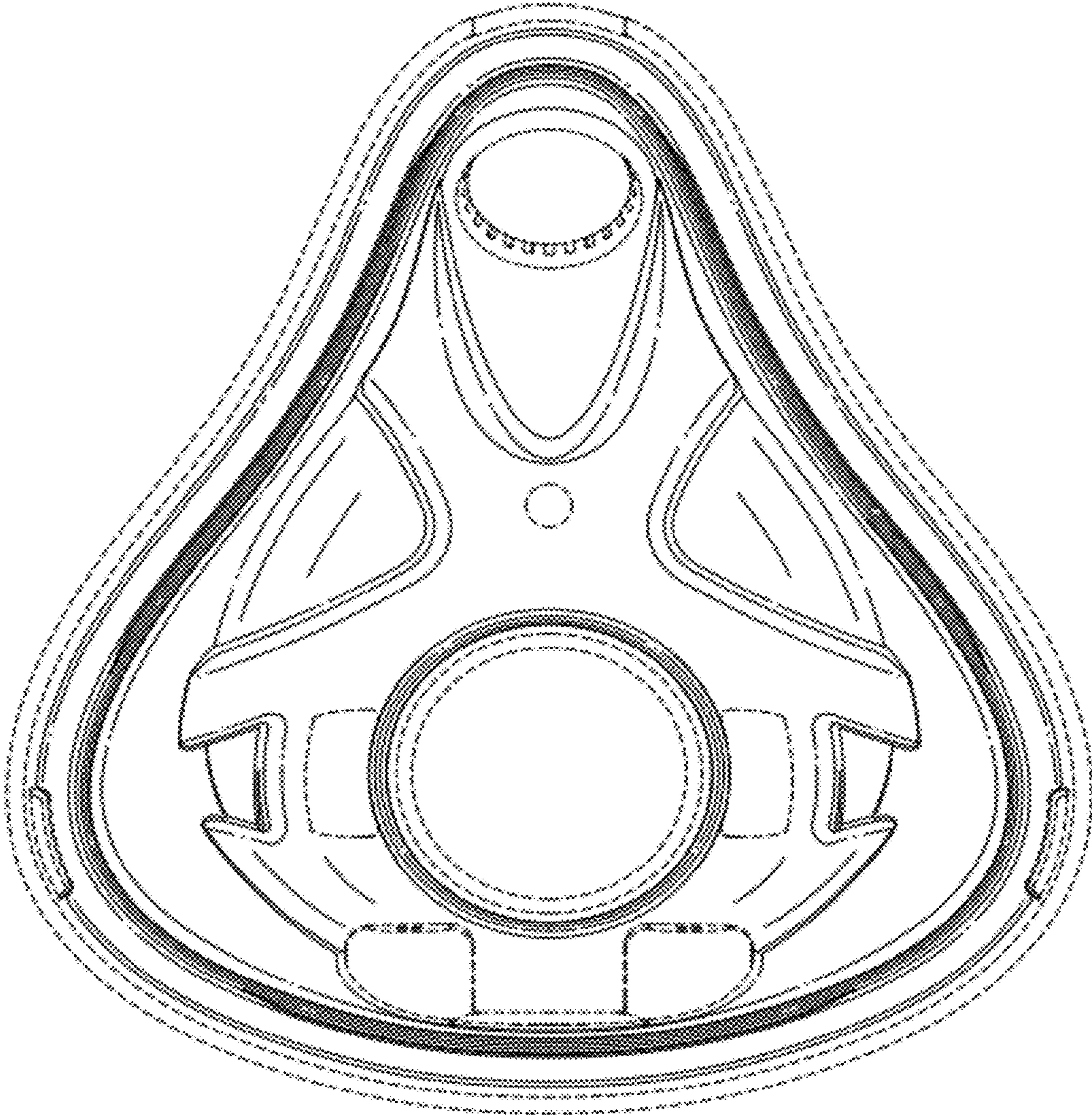

Fig. 3

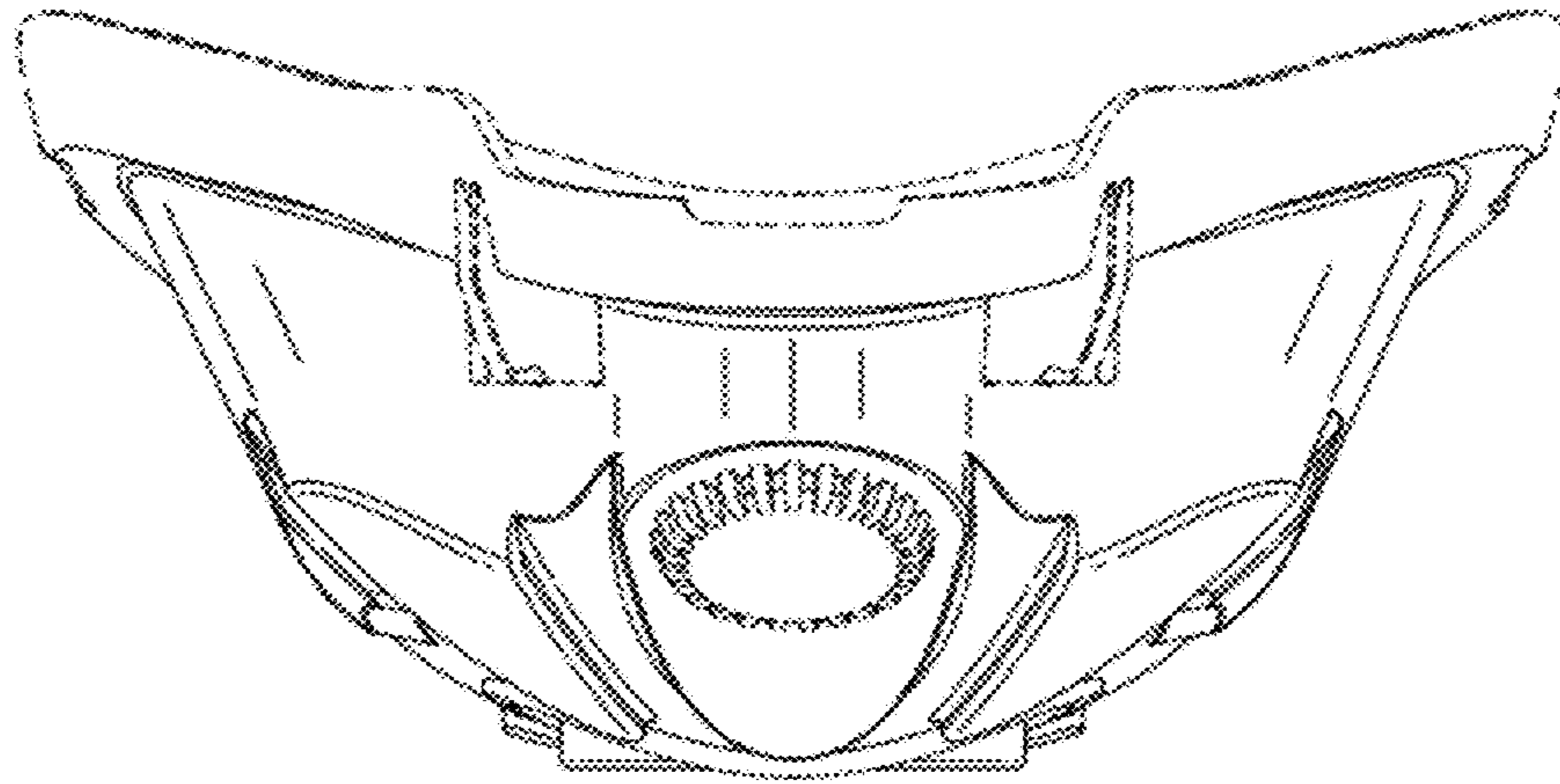

Fig. 4

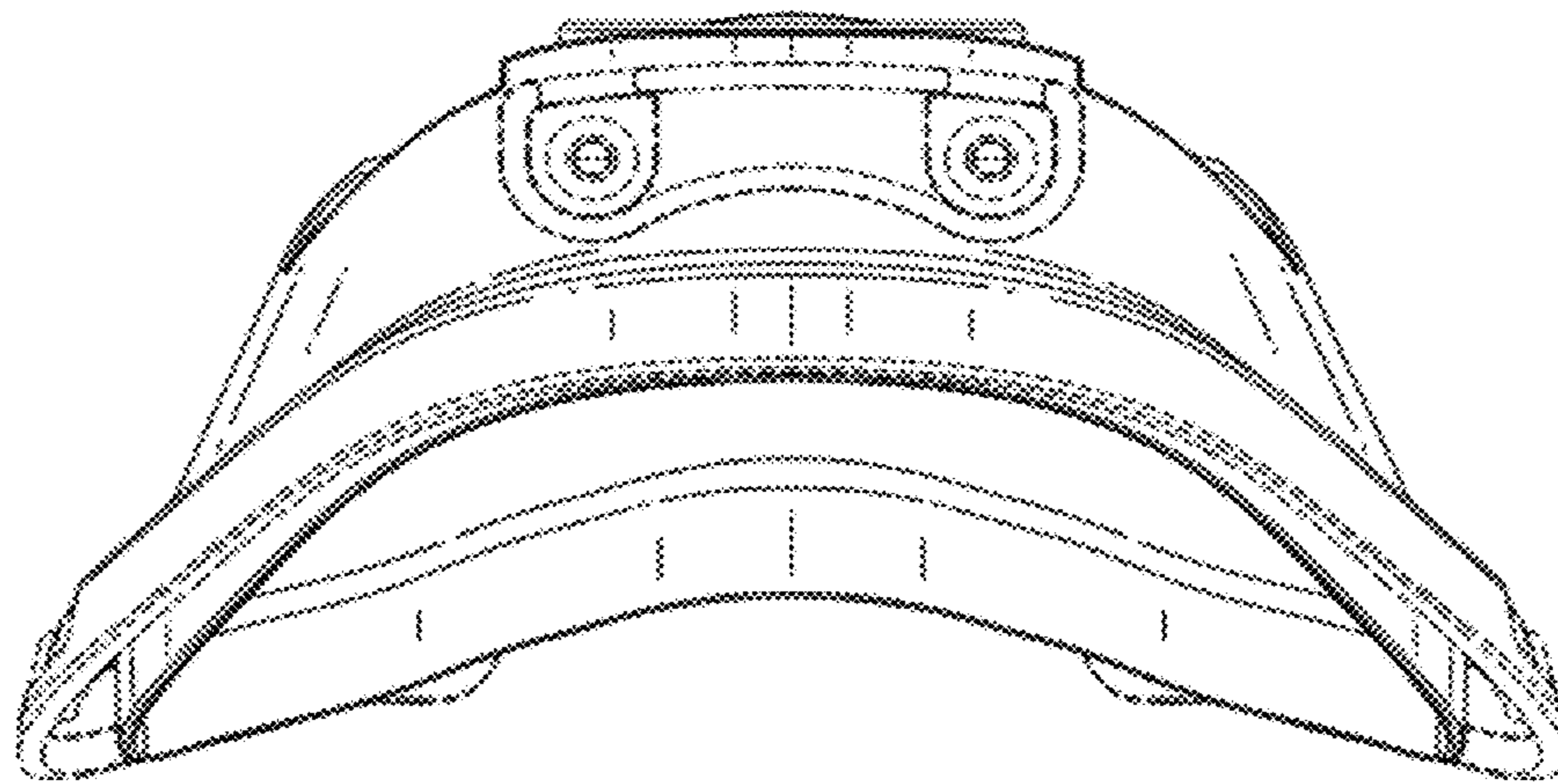

Fig. 5

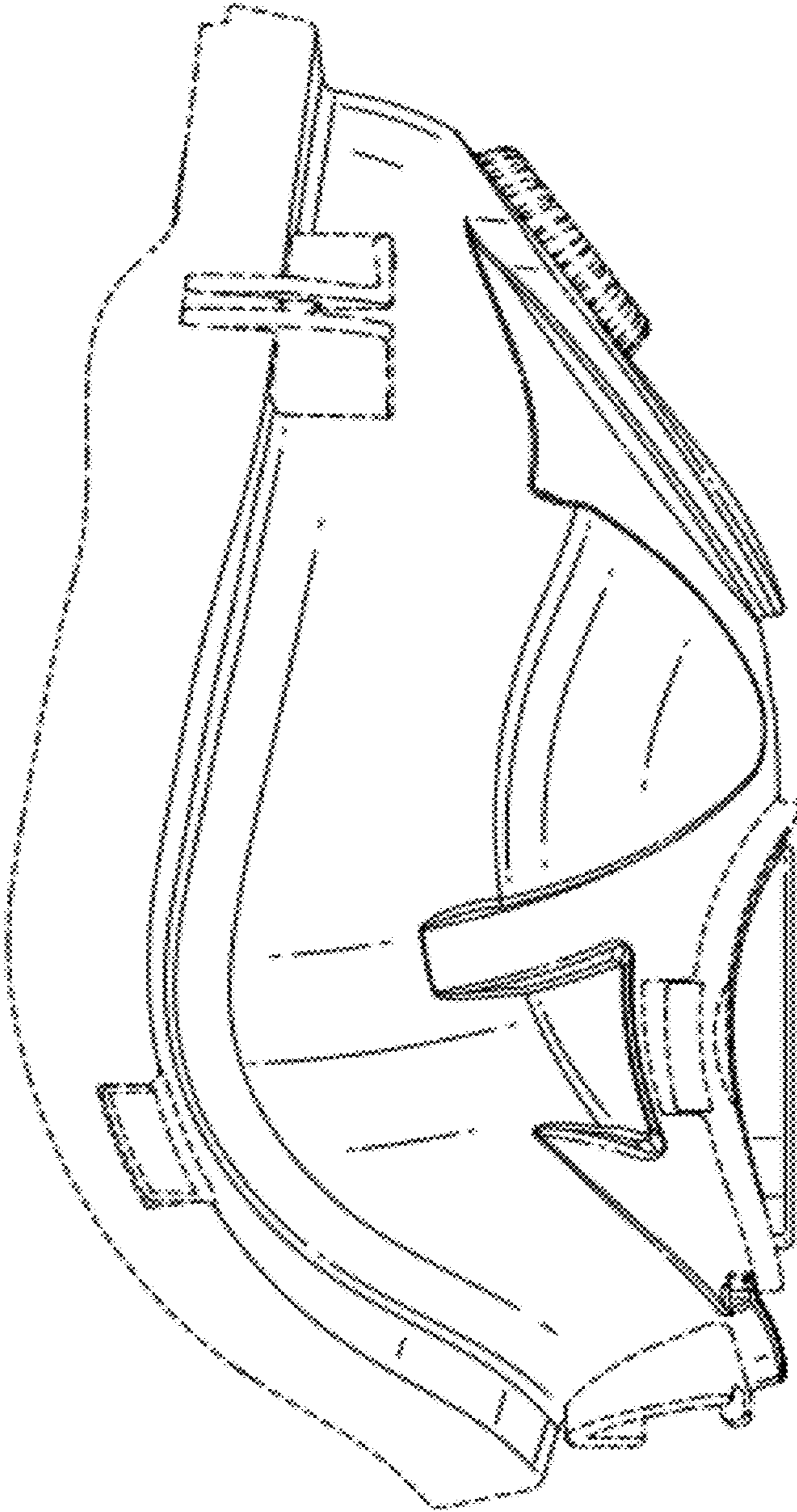

Fig. 6

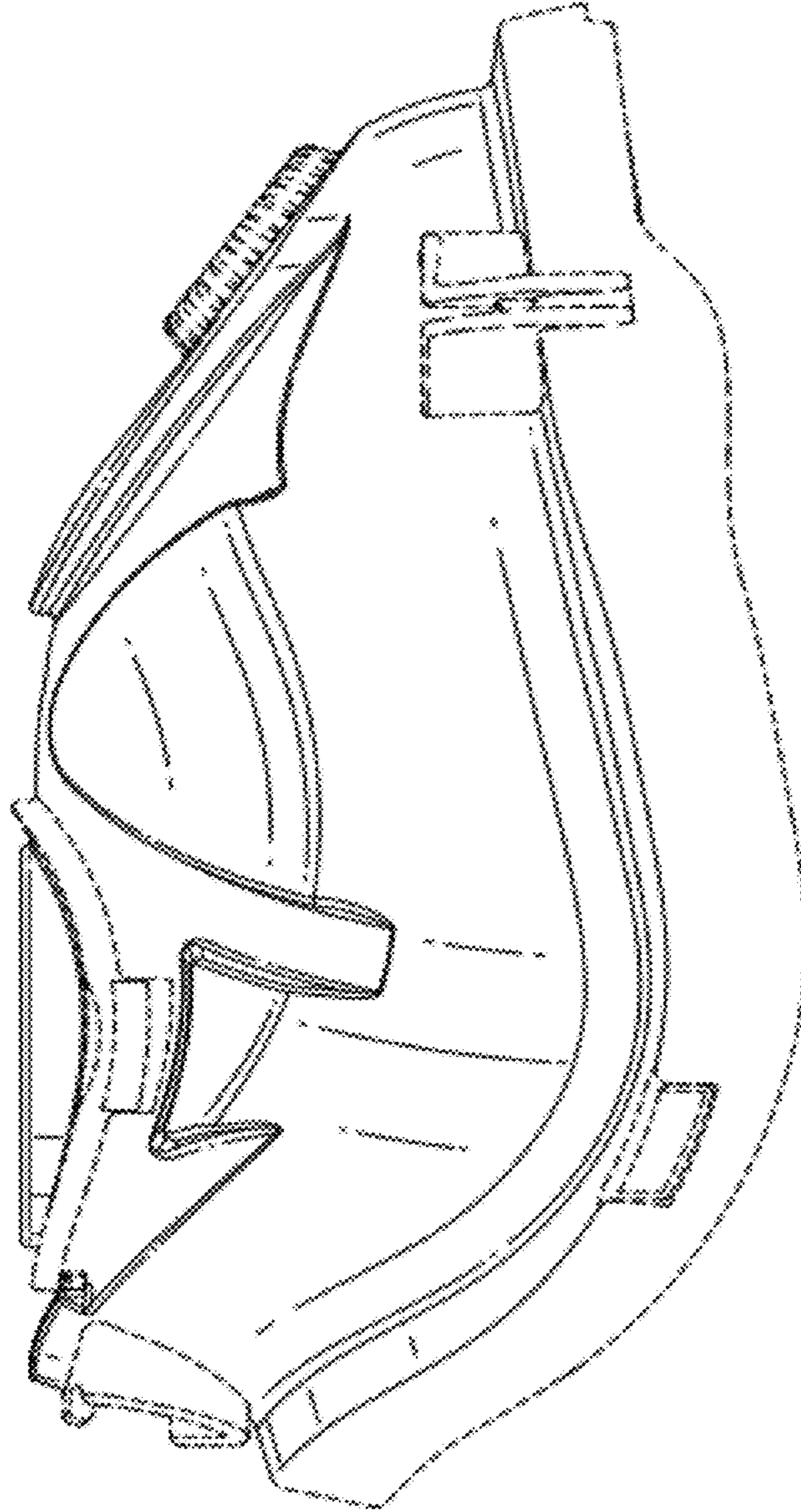

Fig. 7

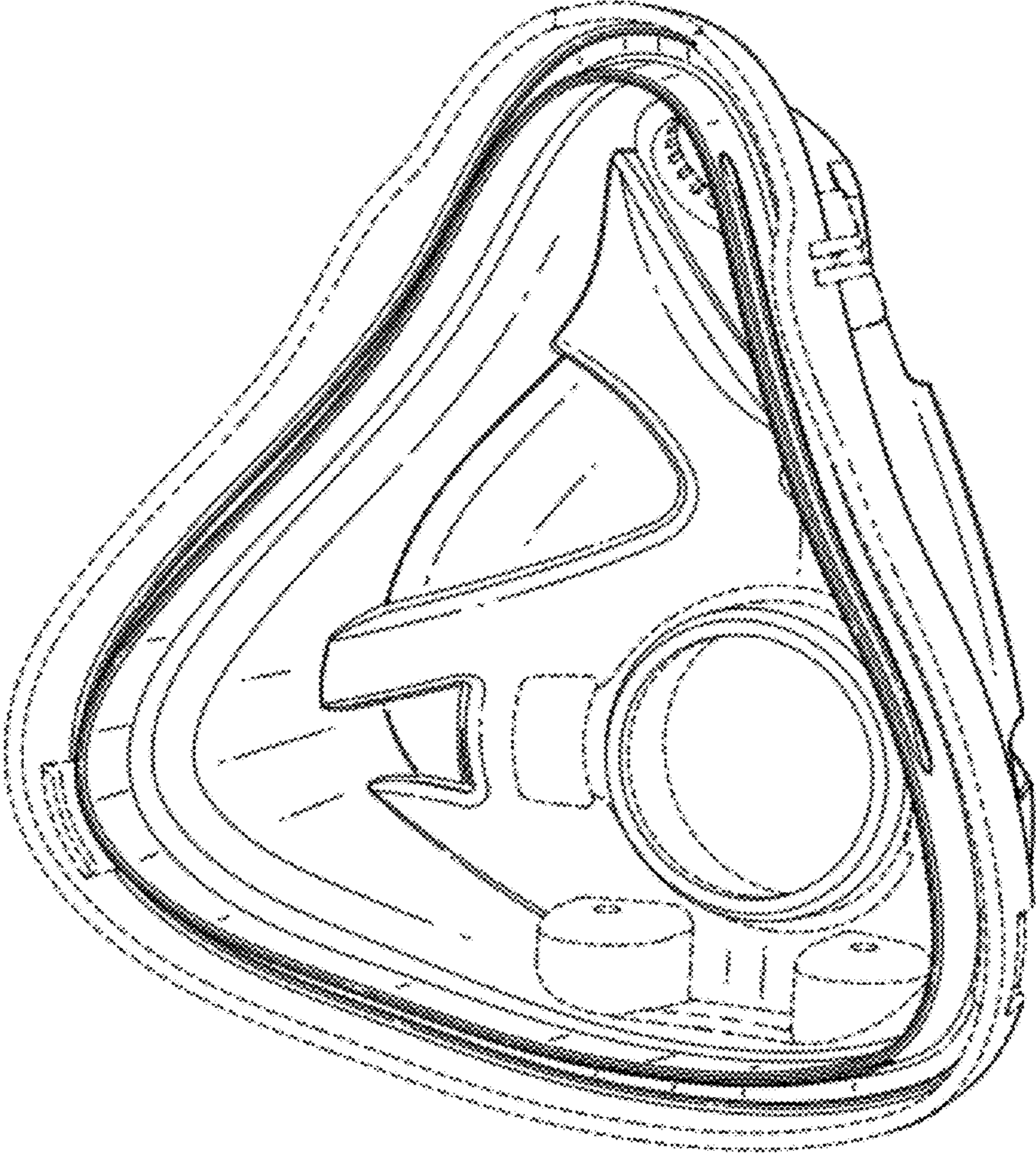

Fig. 8