



US00D677774S

(12) **United States Design Patent**
Postma

(10) **Patent No.:** **US D677,774 S**
(45) **Date of Patent:** **** Mar. 12, 2013**

(54) **VAPORIZER HEATING ASSEMBLY**

(76) Inventor: **Herbert F. Postma**, Boca Raton, FL
(US)

(**) Term: **14 Years**

(21) Appl. No.: **29/406,840**

(22) Filed: **Nov. 18, 2011**

(51) **LOC (9) Cl.** **23-04**

(52) **U.S. Cl.** **D23/360**

(58) **Field of Classification Search** D23/355-366,
D23/352, 369, 332, 333, 335, 336, 342, 351;
422/120, 122; 55/356, 473, 504; 96/97;
261/DIG. 17, DIG. 65, DIG. 88, DIG. 31;
239/7, 34; 128/200.16

See application file for complete search history.

(56) **References Cited**

U.S. PATENT DOCUMENTS

4,294,407	A *	10/1981	Reichl et al.	261/DIG. 65
D377,214	S *	1/1997	Seeley	D23/365
5,893,515	A *	4/1999	Hahn et al.	239/7
D503,467	S *	3/2005	Flashinski et al.	D23/366
D539,883	S *	4/2007	Lee et al.	D23/351
D575,860	S *	8/2008	Wu	D23/366
D619,236	S *	7/2010	Schlag et al.	D23/351
7,779,830	B2 *	8/2010	Koerner et al.	128/200.16
D649,236	S *	11/2011	Bilko et al.	D23/366
D654,160	S *	2/2012	Yomtov	D23/360
D657,033	S *	4/2012	Chouji	D23/351
D657,857	S *	4/2012	Choi	D23/364
2010/0140371	A1 *	6/2010	Zuo	239/34

* cited by examiner

Primary Examiner — David Muller

(74) *Attorney, Agent, or Firm* — The Concept Law Group,
P.A.; Scott D. Smiley; Mark C. Johnson

(57) **CLAIM**

The ornamental design for a vaporizer heating assembly, as shown and described.

DESCRIPTION

FIG. 1 is a perspective downward-looking front view of a vaporizer heating assembly according to the present invention;

FIG. 2 is a front elevation view thereof;

FIG. 3 is a rear elevation view thereof;

FIG. 4 is a right side elevation view thereof;

FIG. 5 is a left side elevation view thereof;

FIG. 6 is a top plan view thereof;

FIG. 7 is a top plan view of the vaporizer heating assembly of FIG. 1 with a vapor tube extended from the top and right side; FIG. 8 is a bottom plan view of the vaporizer heating assembly of FIG. 1;

FIG. 9 is a perspective downward-looking front view of the vaporizer heating assembly of FIG. 1 with the lid open and exposing the vapor tube of FIG. 7 in a stored position;

FIG. 10 is a perspective downward-looking front view of the vaporizer heating assembly of FIG. 1 with the vapor tube of FIG. 7 extending from the top and right side; and,

FIG. 11 is a front elevation view of the vaporizer heating assembly of FIG. 1 with the vapor tube of FIG. 7 extending from the top and right side.

The broken lines showing display characters and function buttons on the front surface form no part of the claimed design.

1 Claim, 8 Drawing Sheets

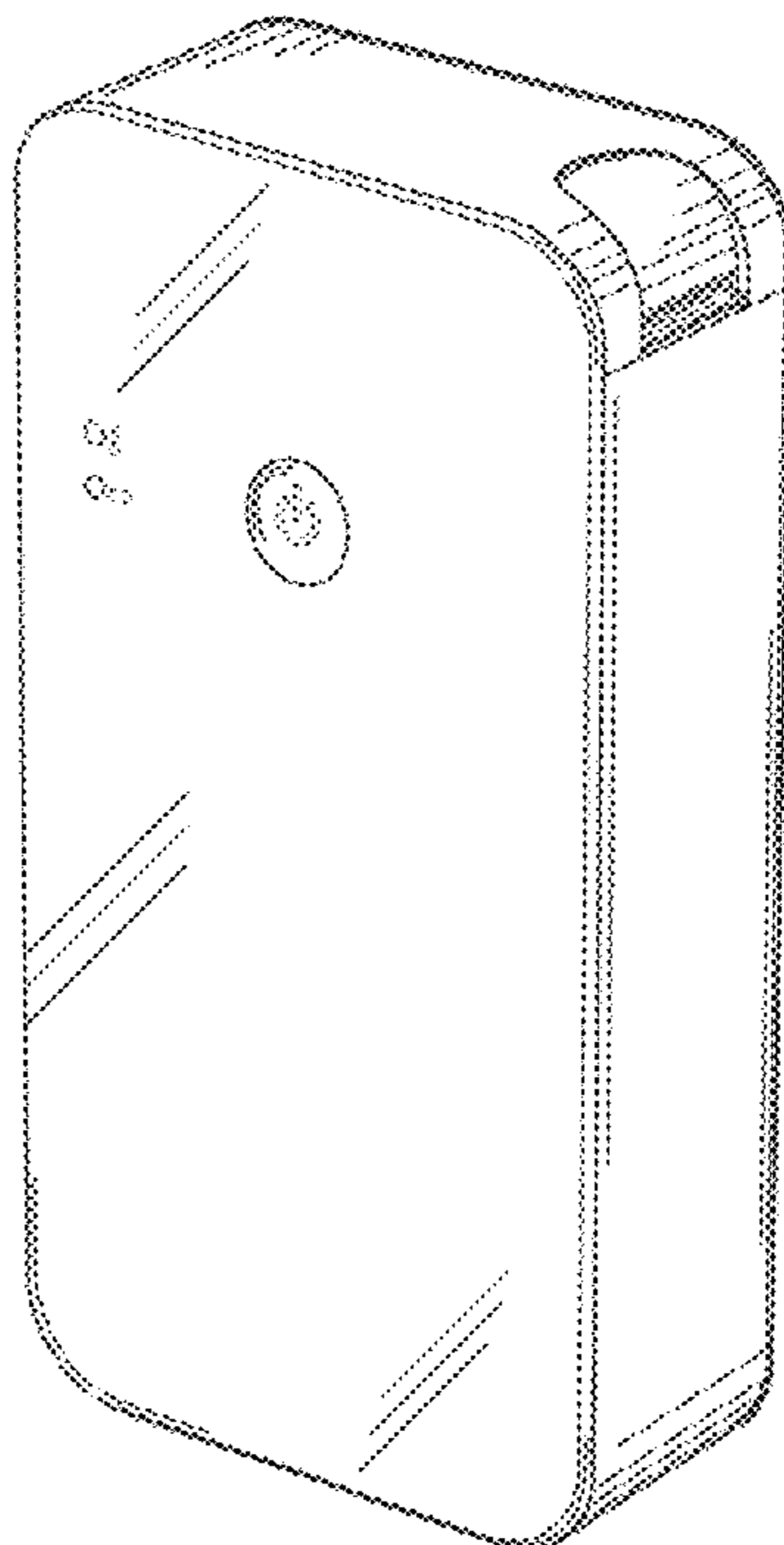

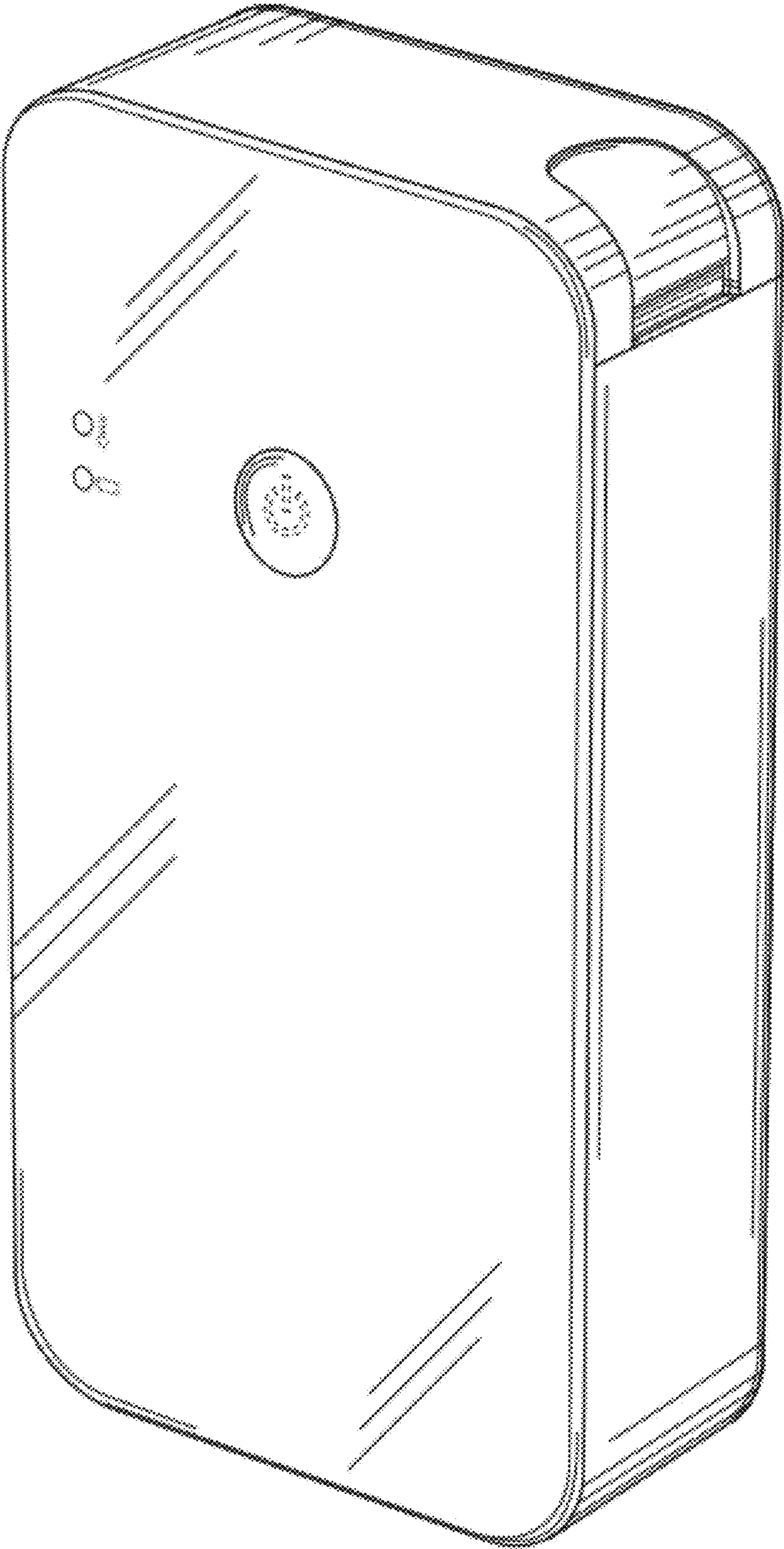

FIG. 1

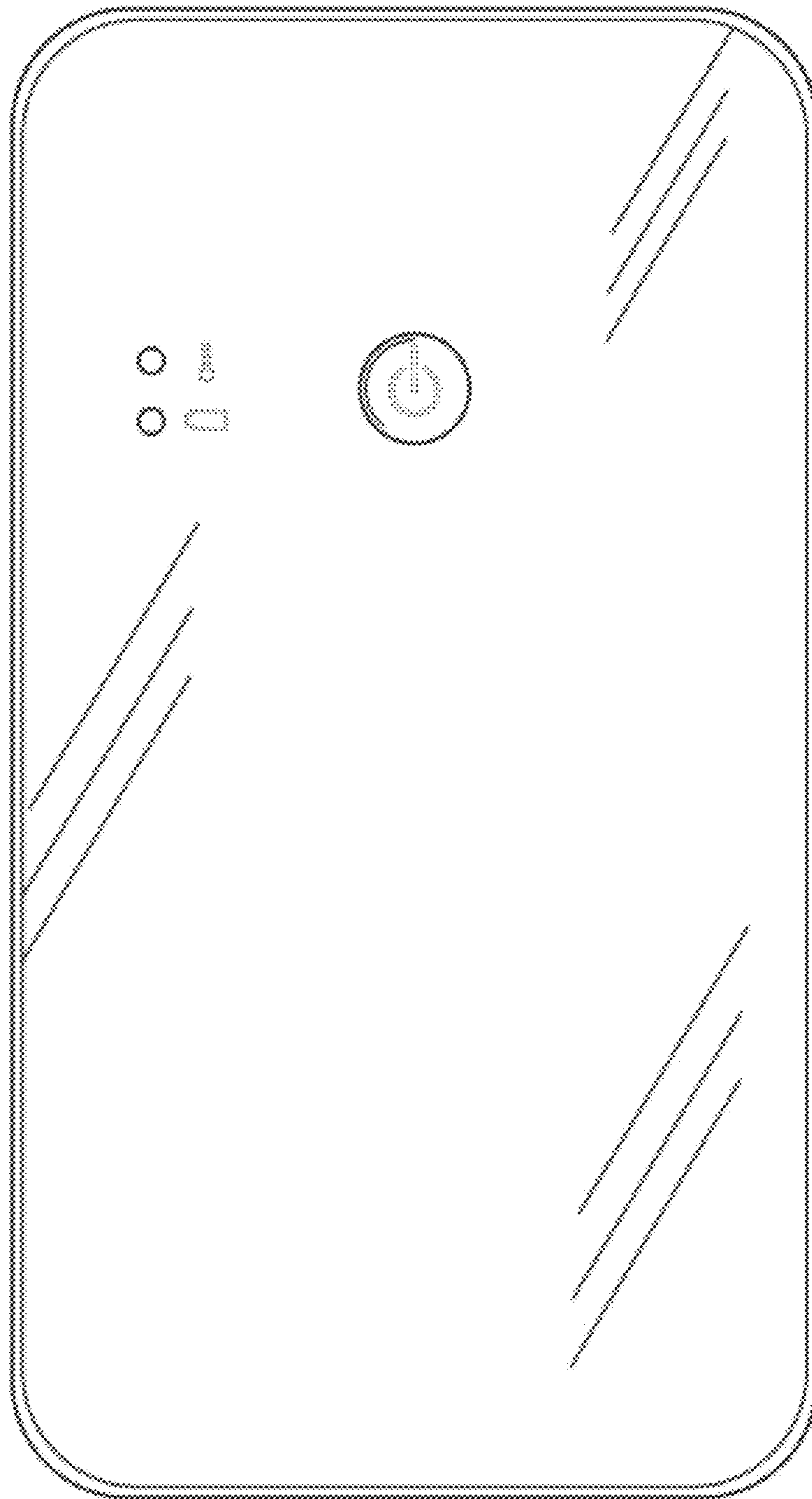

FIG. 2

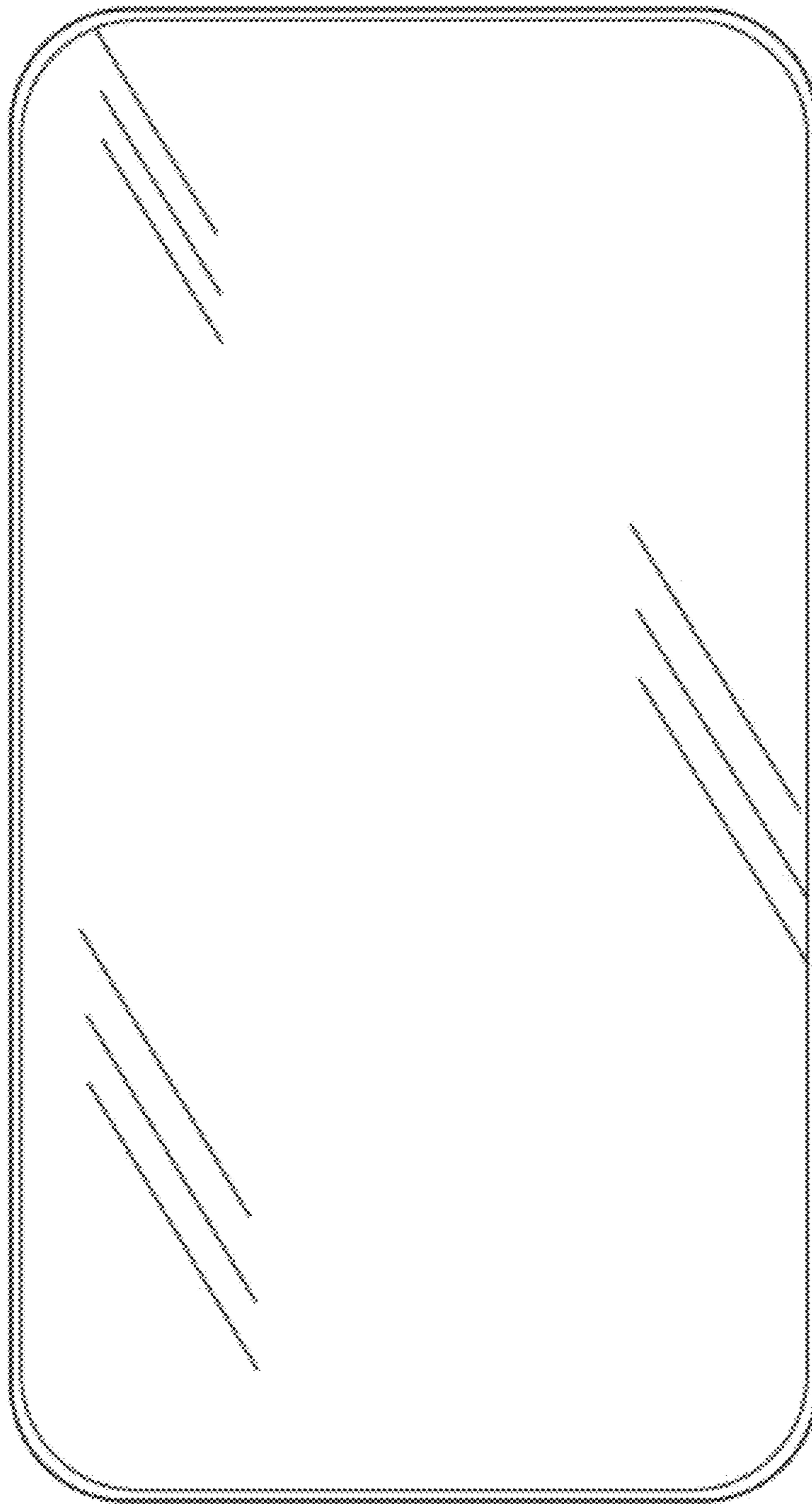

FIG. 3

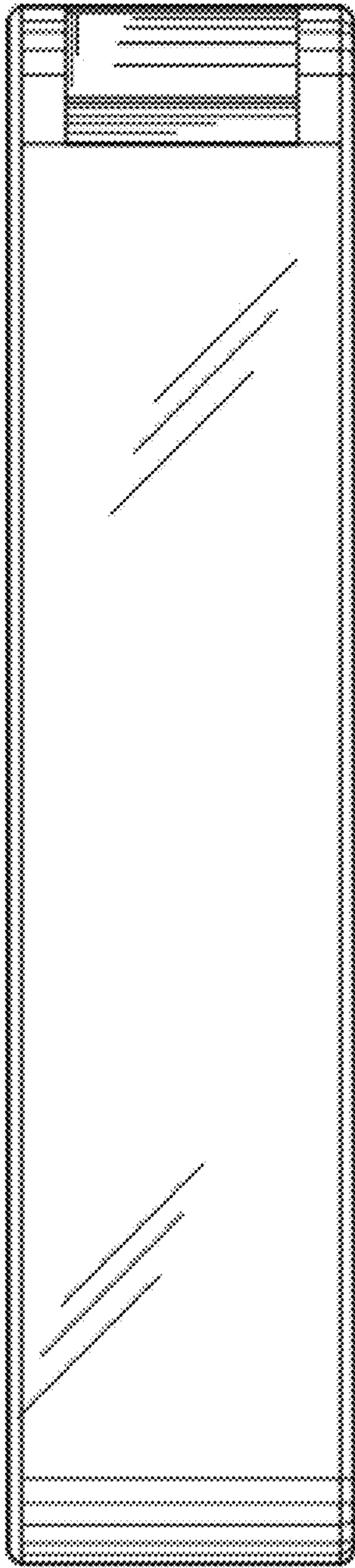

FIG. 4

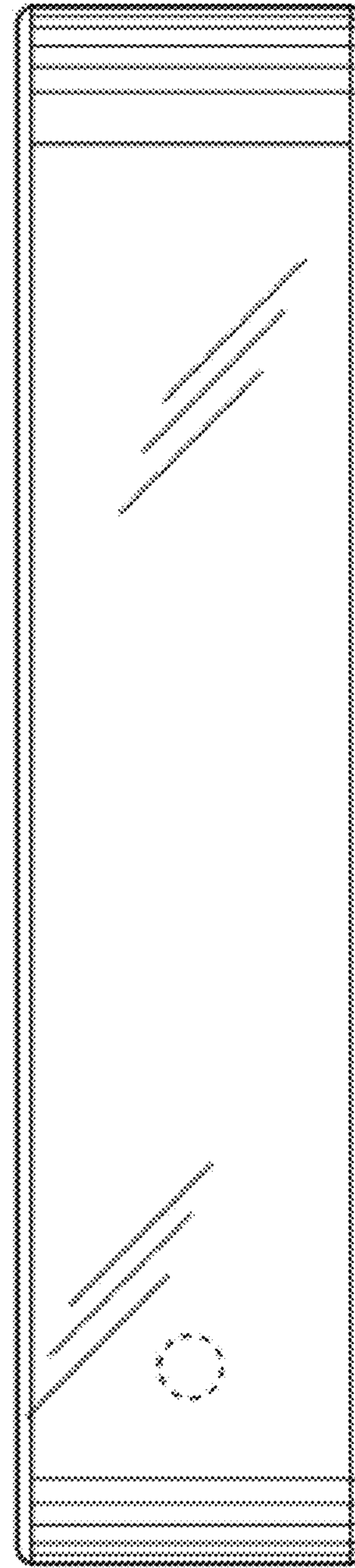

FIG. 5

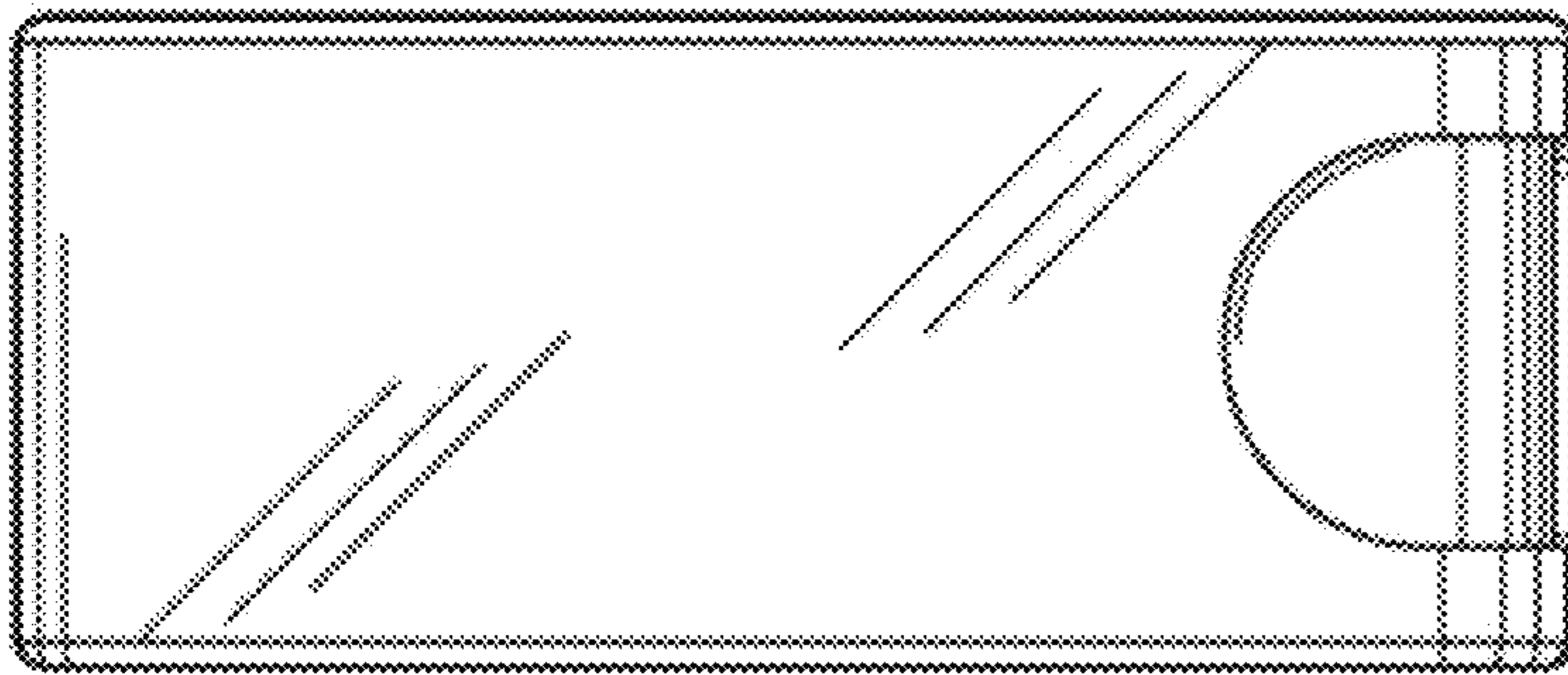

FIG. 6

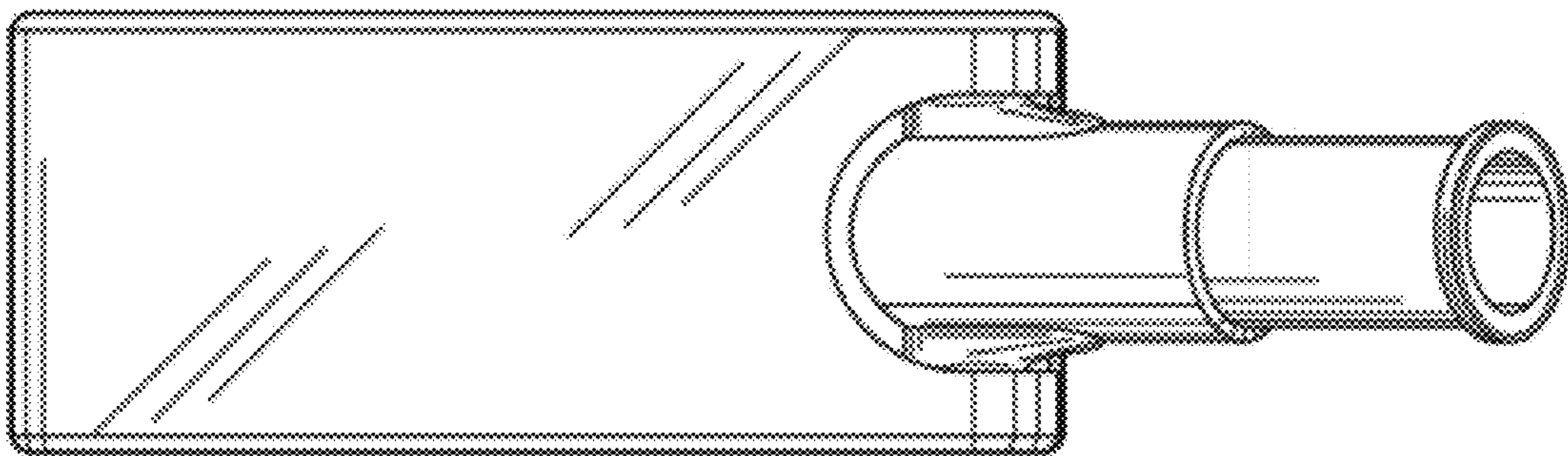

FIG. 7

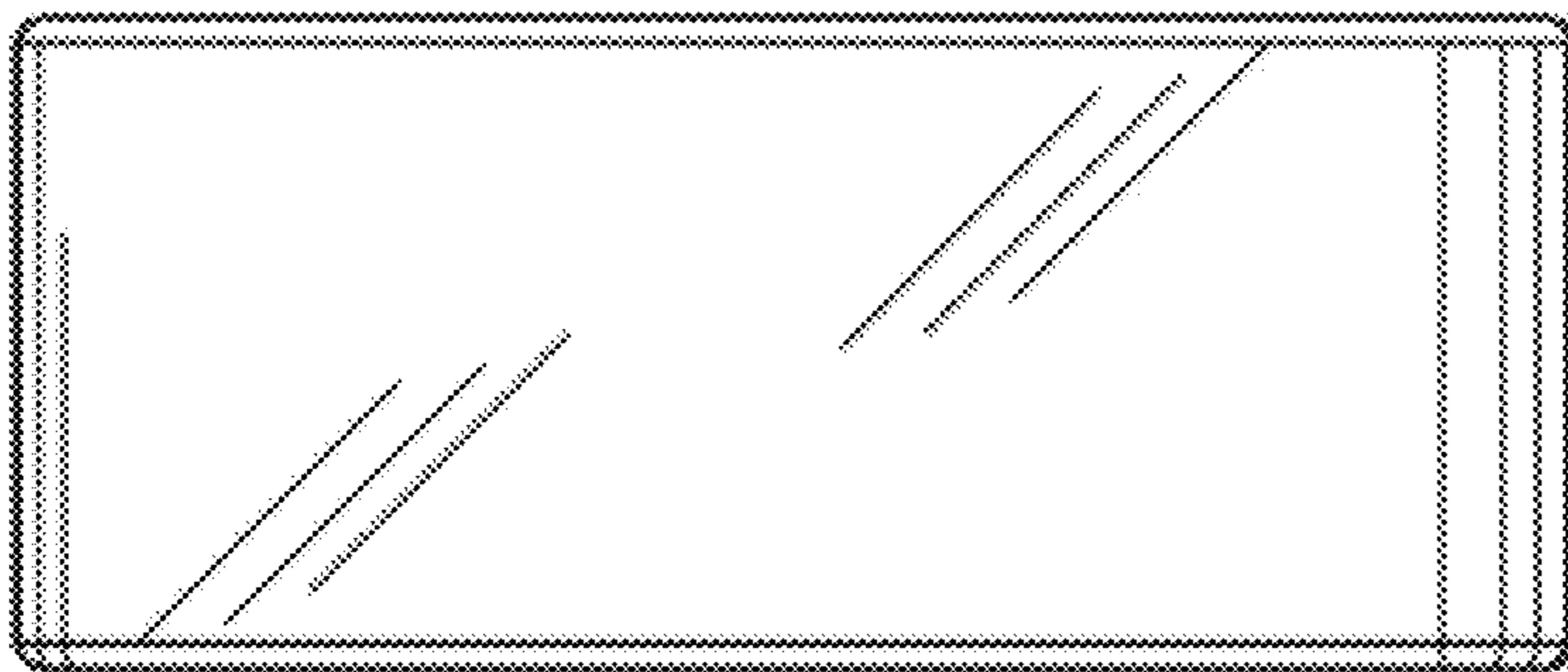

FIG. 8

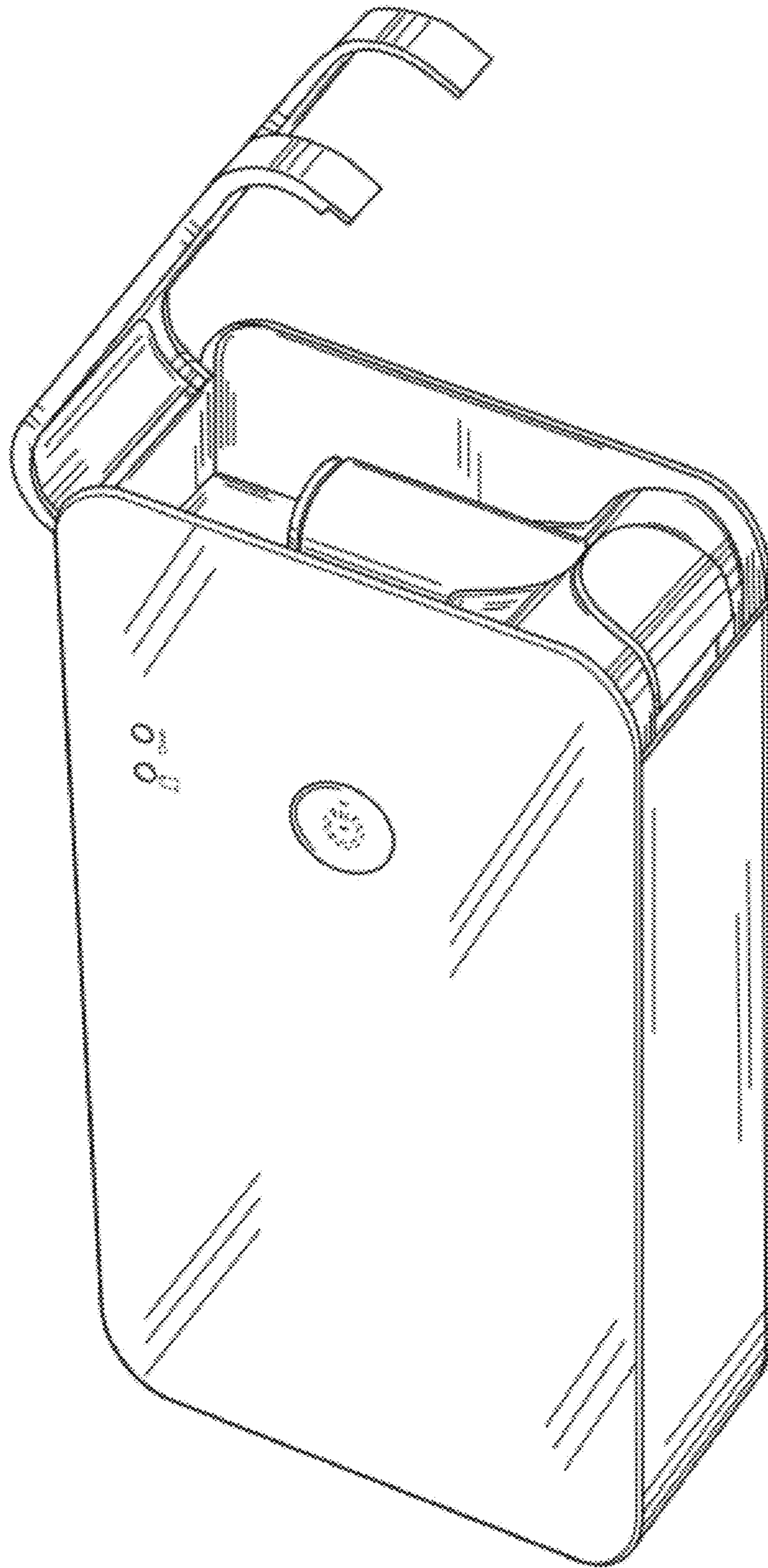

FIG. 9

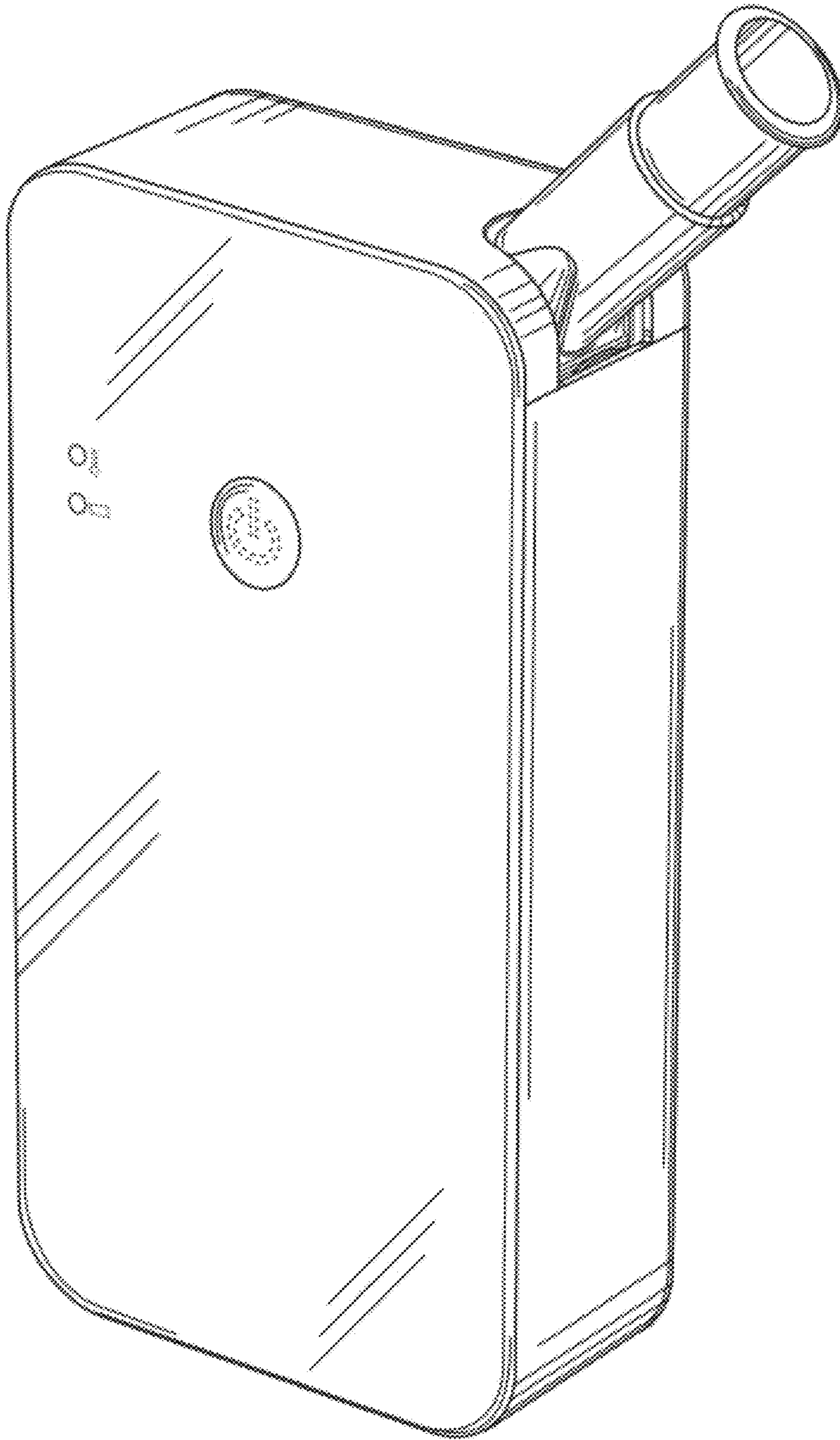

FIG. 10

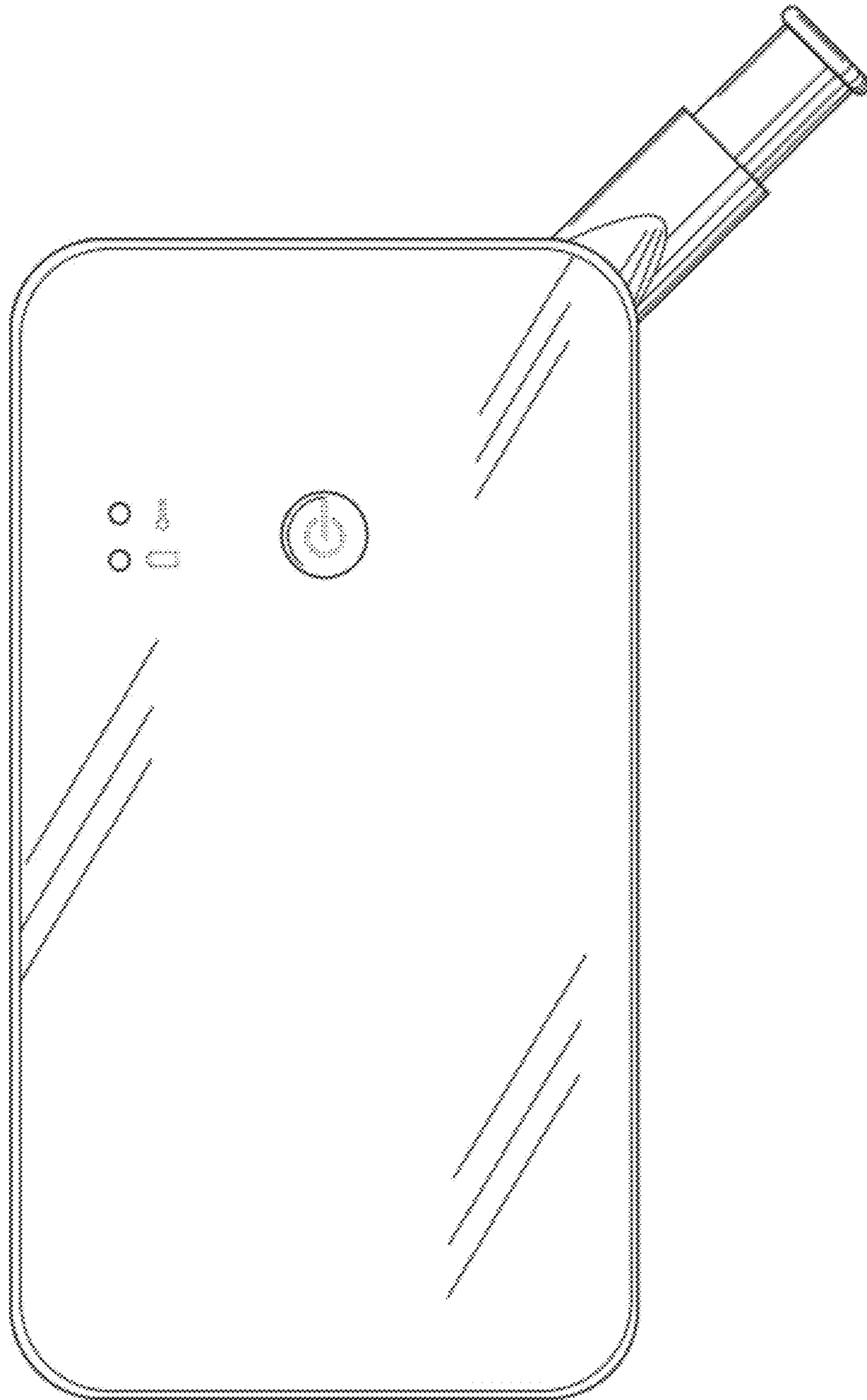

FIG. 11