



US00D677751S

(12) **United States Design Patent**
Olguin

(10) **Patent No.:** **US D677,751 S**
(45) **Date of Patent:** **** Mar. 12, 2013**

(54) **LOW PROFILE SNAG-LESS FISHING ROD
TIP TOP GUIDE DESIGN**

(75) Inventor: **Grant Olguin**, Palo Alto, CA (US)

(73) Assignee: **Dee Thomas Fishing, LLC**, Palo Alto, CA (US)

(**) Term: **14 Years**

(21) Appl. No.: **29/409,757**

(22) Filed: **Dec. 28, 2011**

(51) **LOC (9) Cl.** **22-05**

(52) **U.S. Cl.** **D22/143**

(58) **Field of Classification Search** D22/143,
D22/137-142; 43/18, 24-25; 242/157 R
See application file for complete search history.

(56) **References Cited**

U.S. PATENT DOCUMENTS

3,060,618	A *	10/1962	Grishkin	43/24
D223,662	S *	5/1972	Coalson	D22/143
4,070,785	A *	1/1978	Hawk	43/24
D374,910	S *	10/1996	Phethean	D22/143
D482,427	S *	11/2003	Park	D22/143
D494,249	S *	8/2004	Grayson	D22/143
D627,032	S *	11/2010	Gimbert	D22/143

* cited by examiner

Primary Examiner — Catheri Oliver-Garcia

(74) *Attorney, Agent, or Firm* — Richard T. Ogawa; Ogawa P.C.

(57) **CLAIM**

The ornamental design for a low profile snag-less fishing rod tip top guide design, shown and described.

DESCRIPTION

FIG. 1 is a perspective view of a fishing rod guide showing an embodiment of my new design;

FIG. 2 is a perspective view of a fishing rod guide on a fishing rod as background for the fishing rod guide of FIG. 1;

FIG. 3 is a side view of the fishing rod guide of FIG. 1;

FIG. 4 is an opposite side view of the fishing rod guide of FIG. 1;

FIG. 5 is a front view of the fishing rod guide of FIG. 1;

FIG. 6 is a rear view of the fishing rod guide of FIG. 1;

FIG. 7 is a top plan view of the fishing rod guide of FIG. 1;

FIG. 8 is a bottom plan view of the fishing rod guide of FIG. 1;

FIG. 9 is a perspective view of a fishing rod guide showing a second embodiment of my design;

FIG. 10 is a perspective view of a fishing rod guide on a fishing rod as background for the fishing rod guide of FIG. 9;

FIG. 11 is a side view of the fishing rod guide of FIG. 9;

FIG. 12 is an opposite side view of the fishing rod guide of FIG. 9;

FIG. 13 is a front view of the fishing rod guide of FIG. 9;

FIG. 14 is a rear view of the fishing rod guide of FIG. 9;

FIG. 15 is a top plan view of the fishing rod guide of FIG. 9; and,

FIG. 16 is a bottom plan view of the fishing rod guide of FIG. 9.

Dotted lines are merely used for better illustration of the fishing rod guide designs thereof. A plurality of dashed lines in part of the figures are used for showing the fishing rod guide designs as a whole thereof while the claimed designs are shown in solid line.

1 Claim, 8 Drawing Sheets

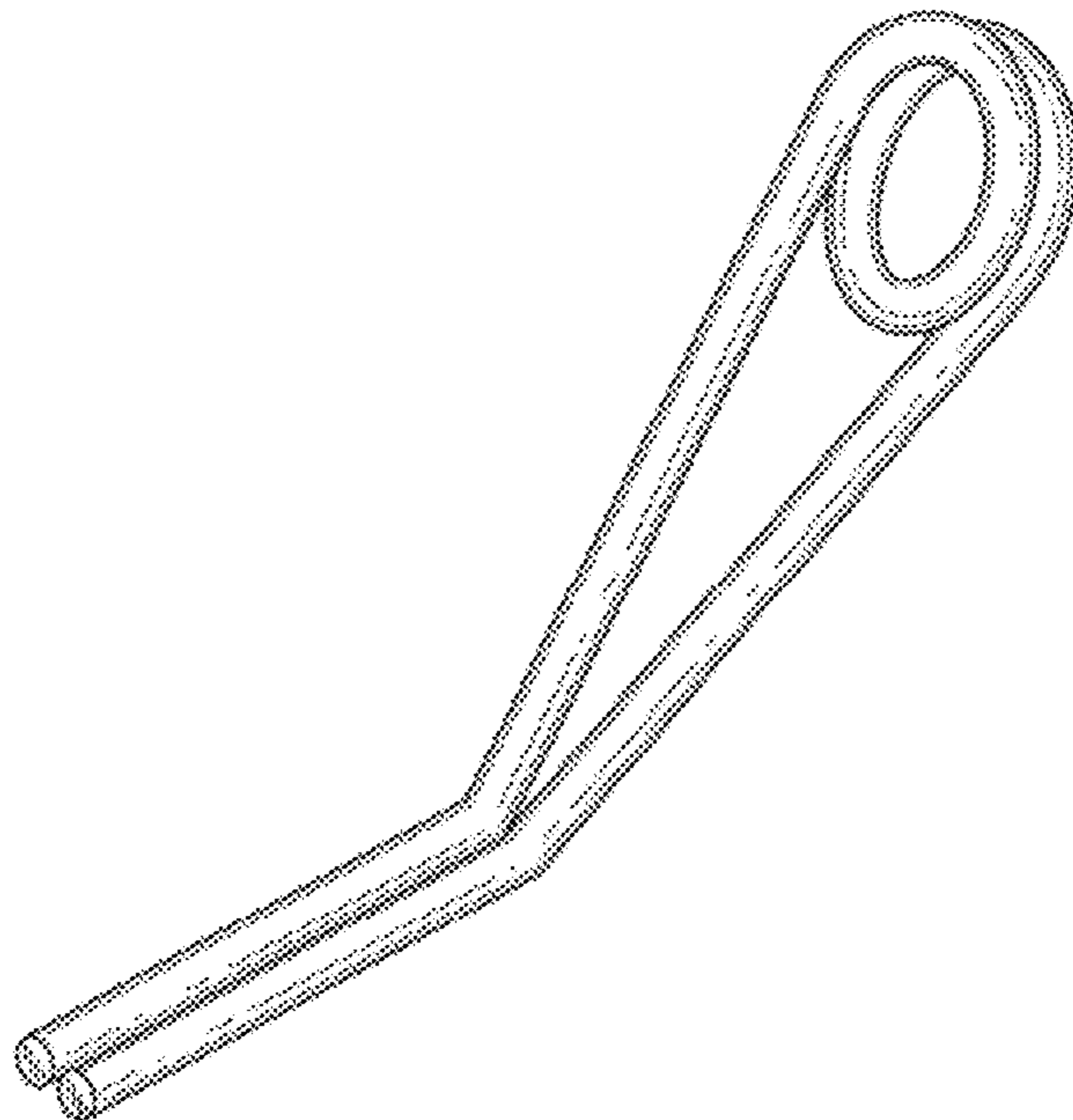

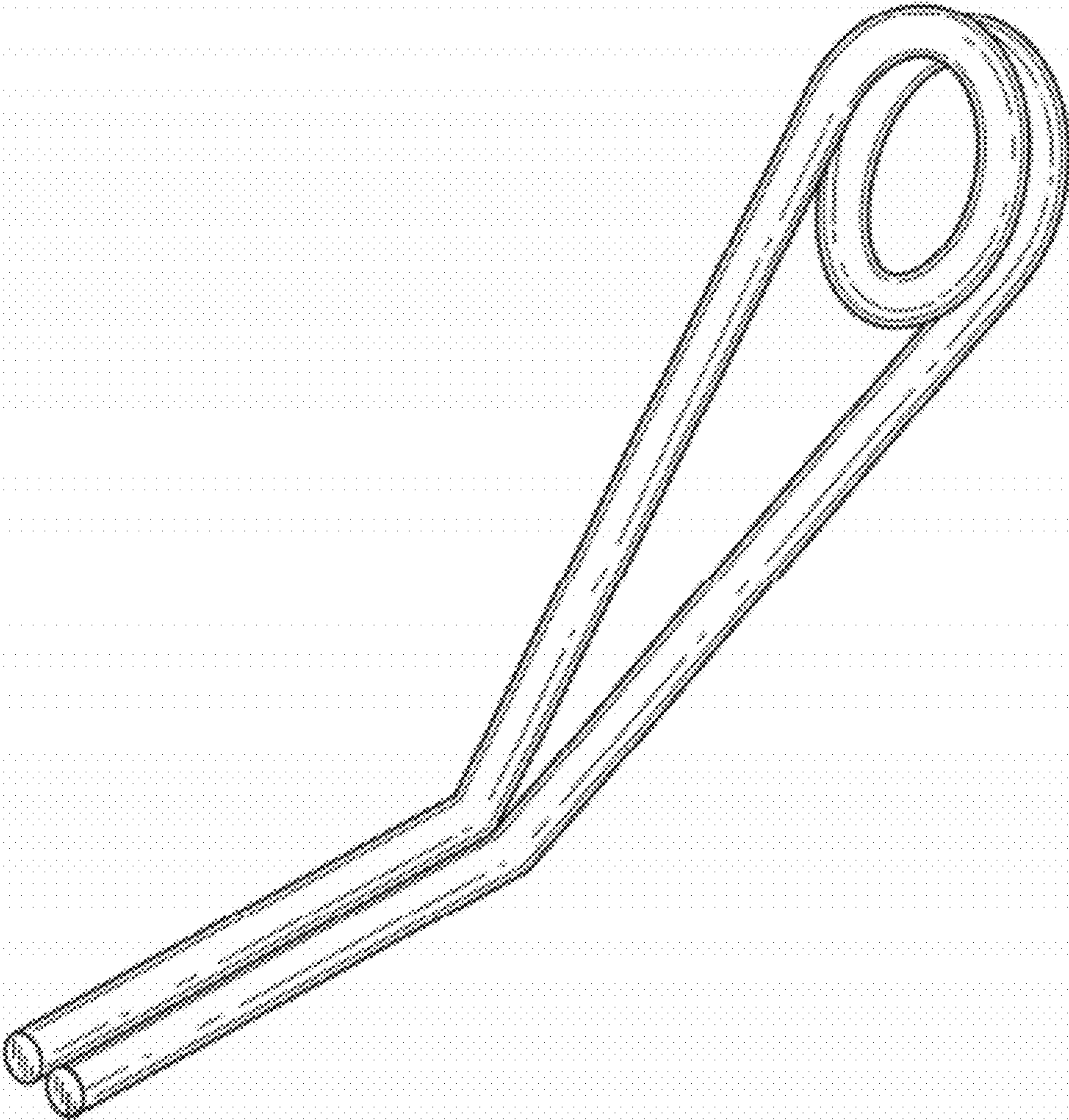

FIG. 1

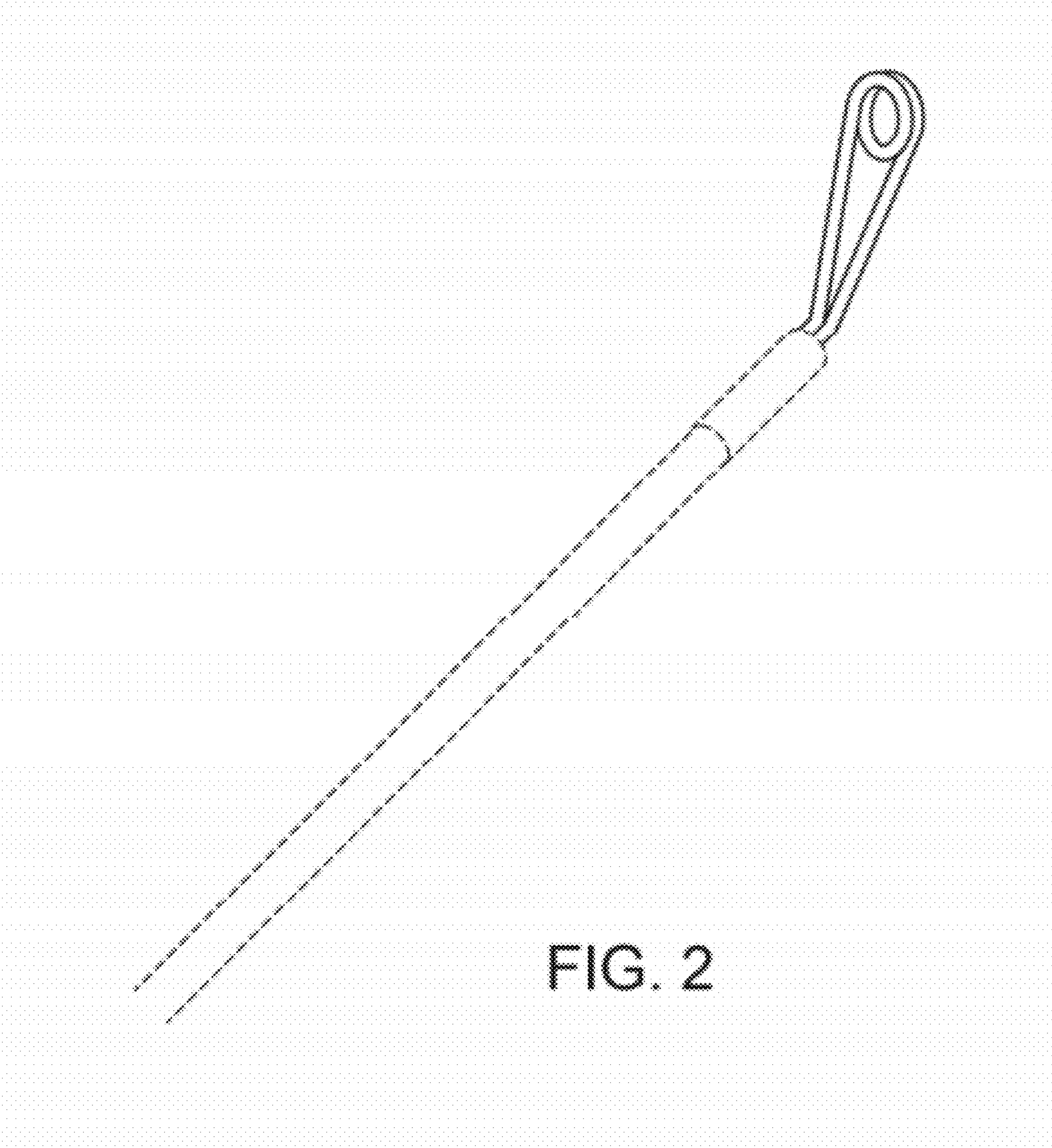

FIG. 2

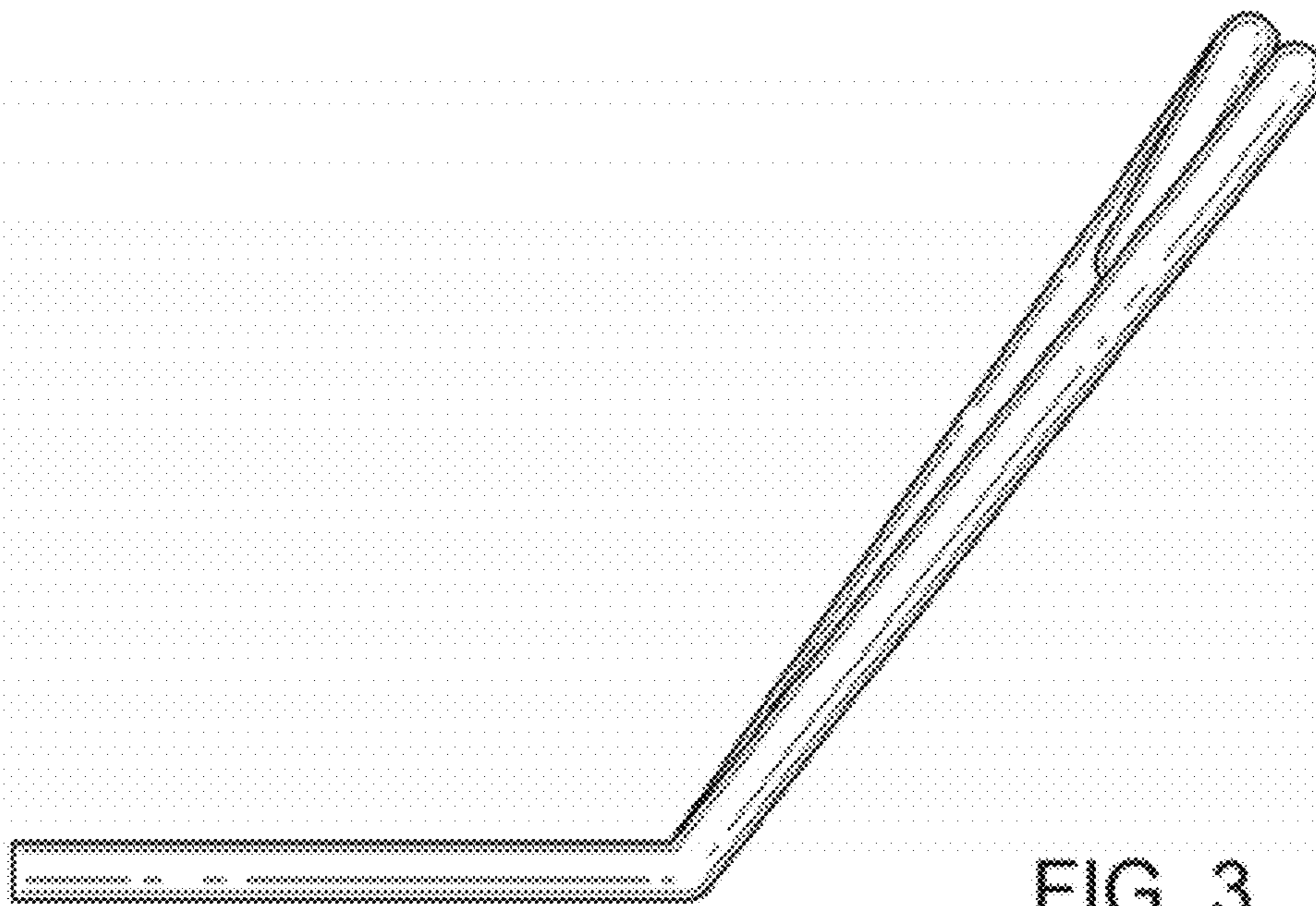

FIG. 3

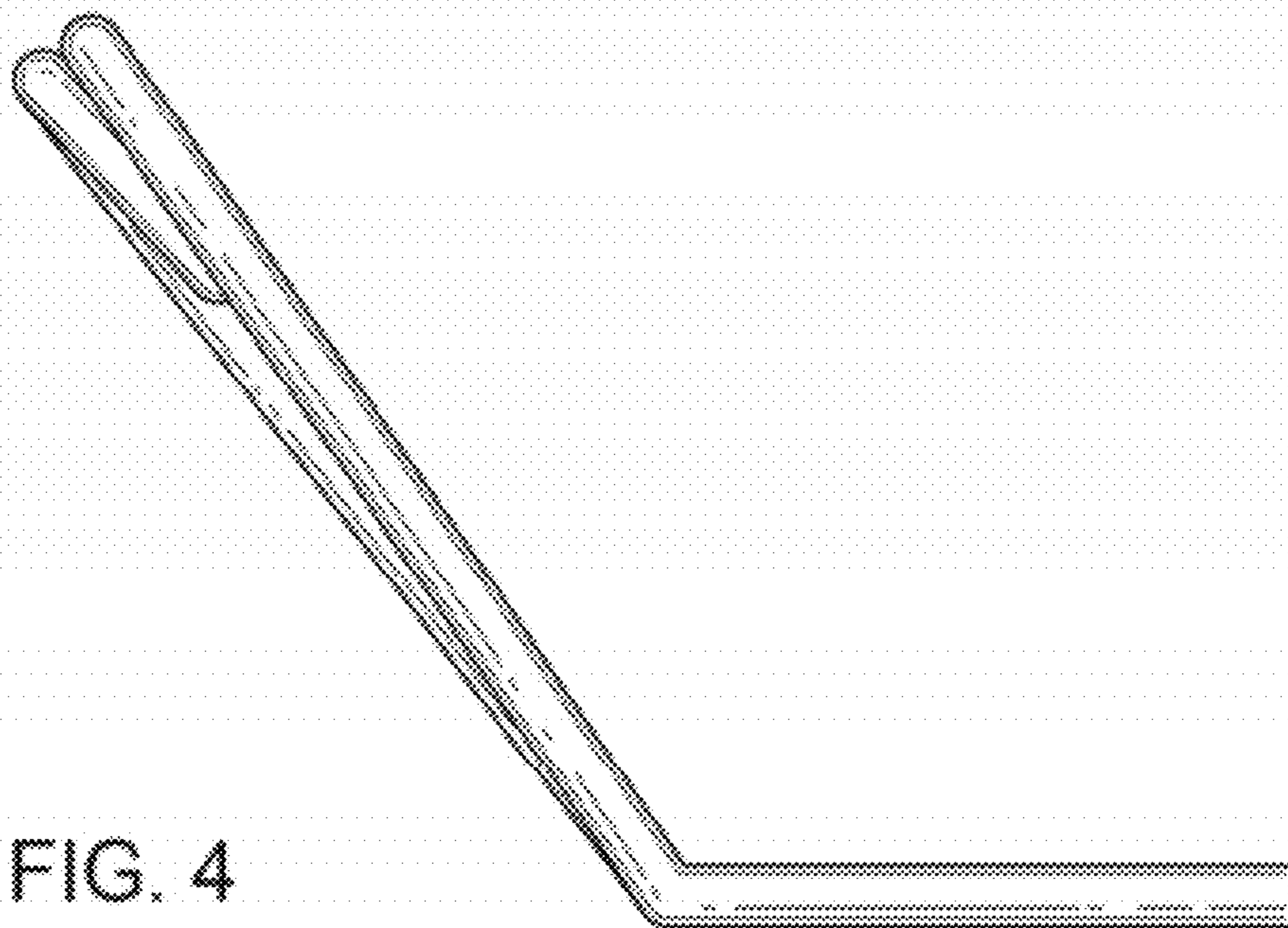

FIG. 4

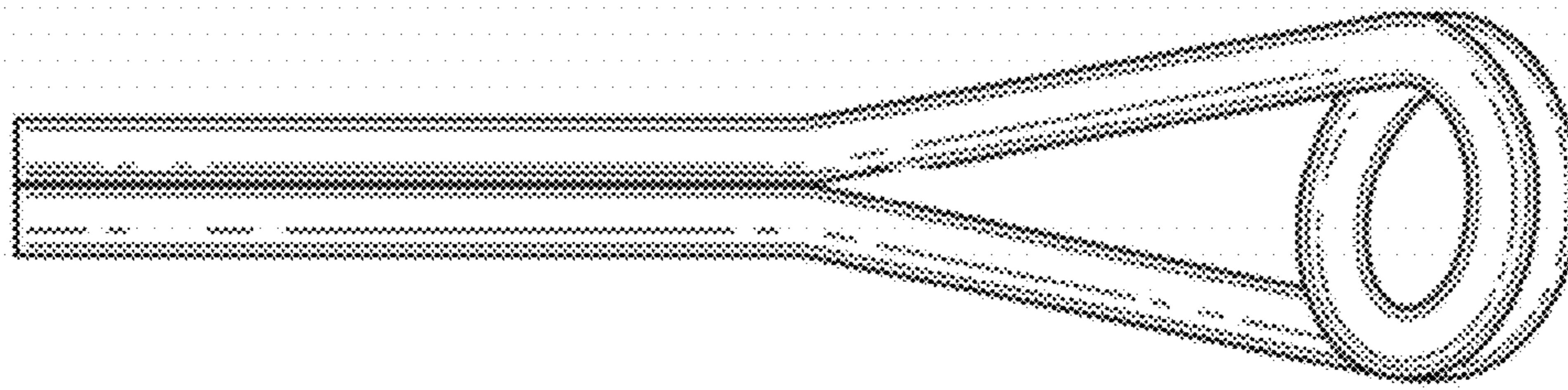

FIG. 5

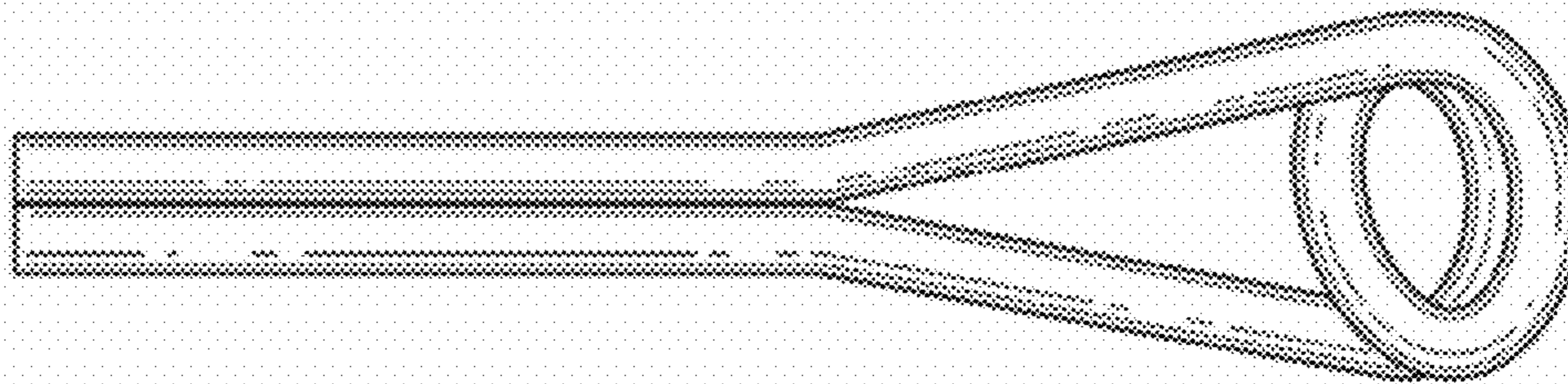

FIG. 6

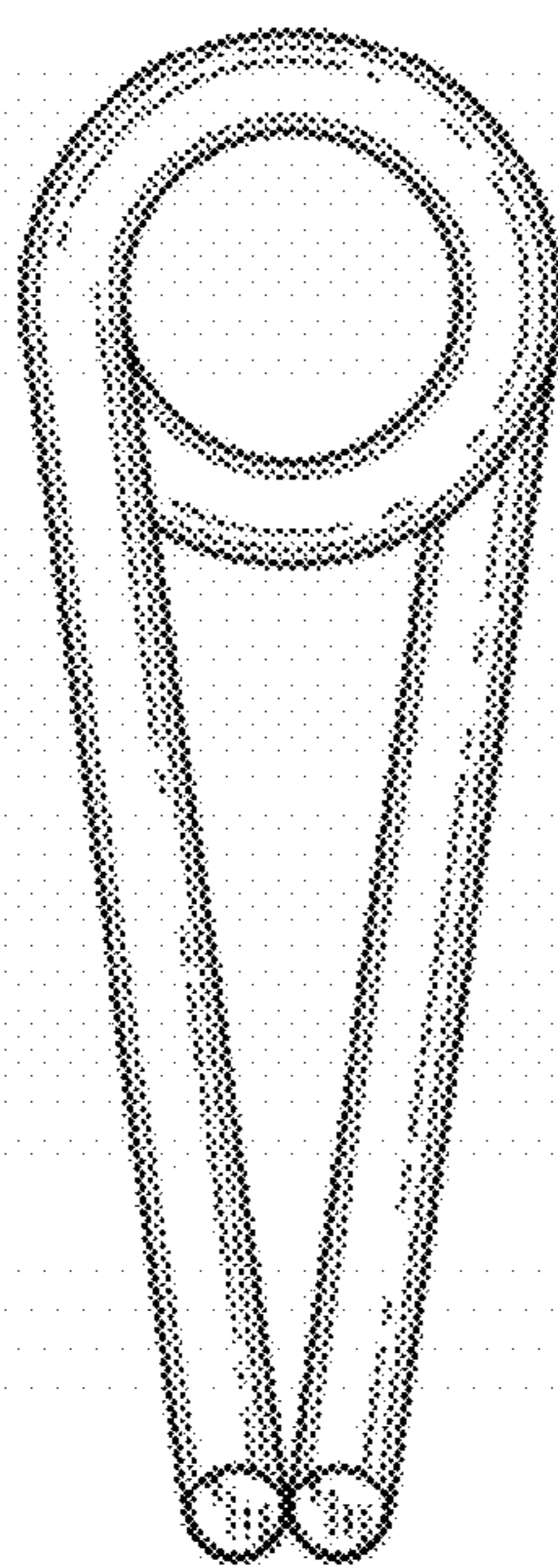

FIG. 7

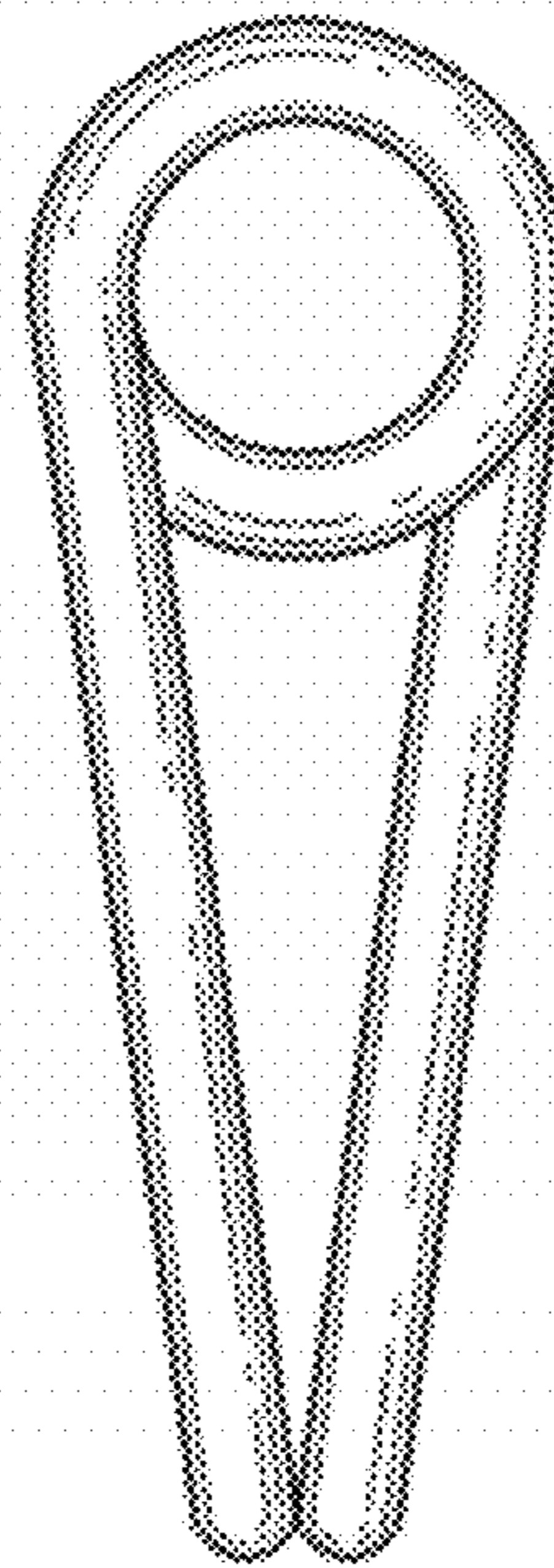

FIG. 8

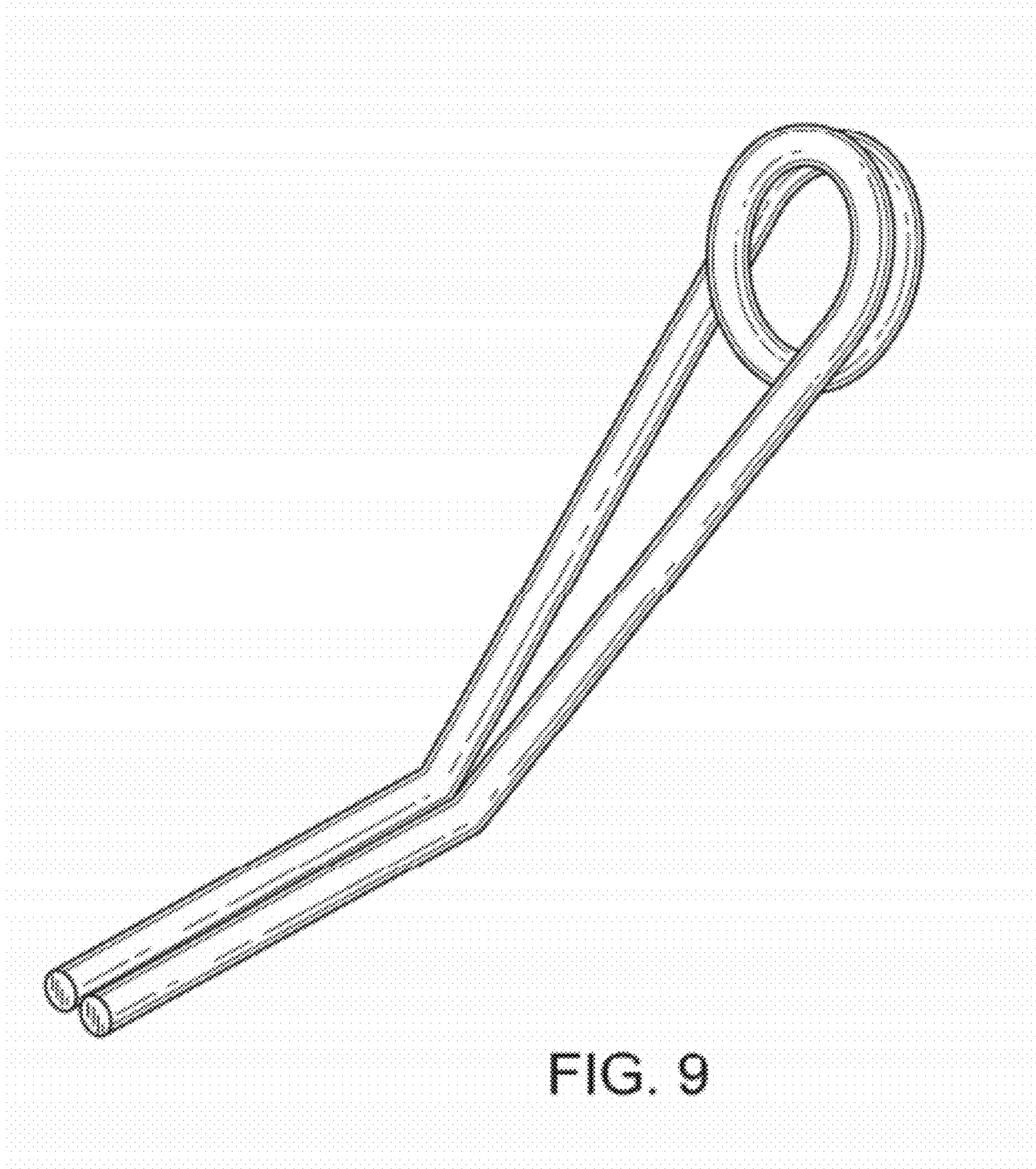

FIG. 9

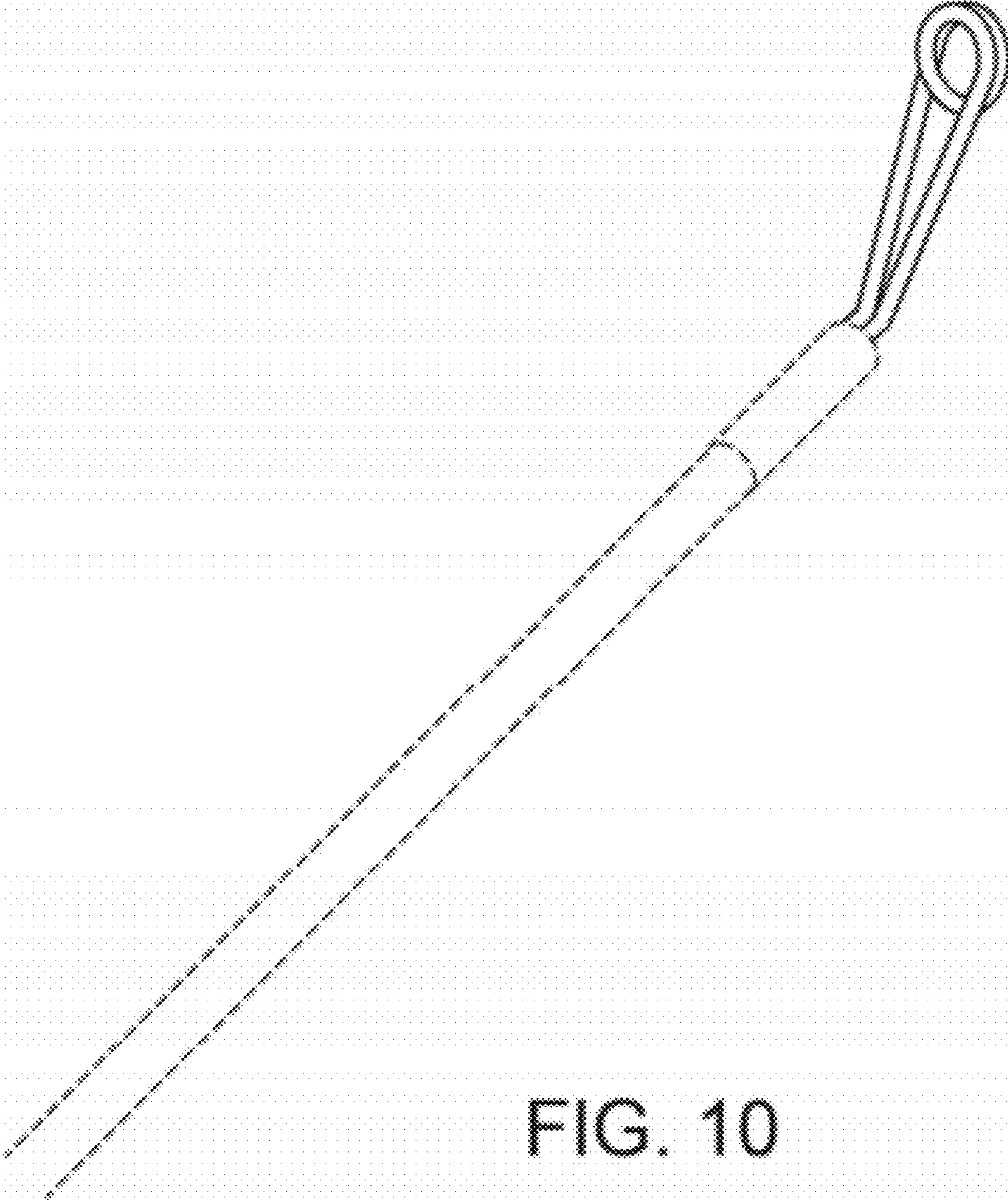

FIG. 10

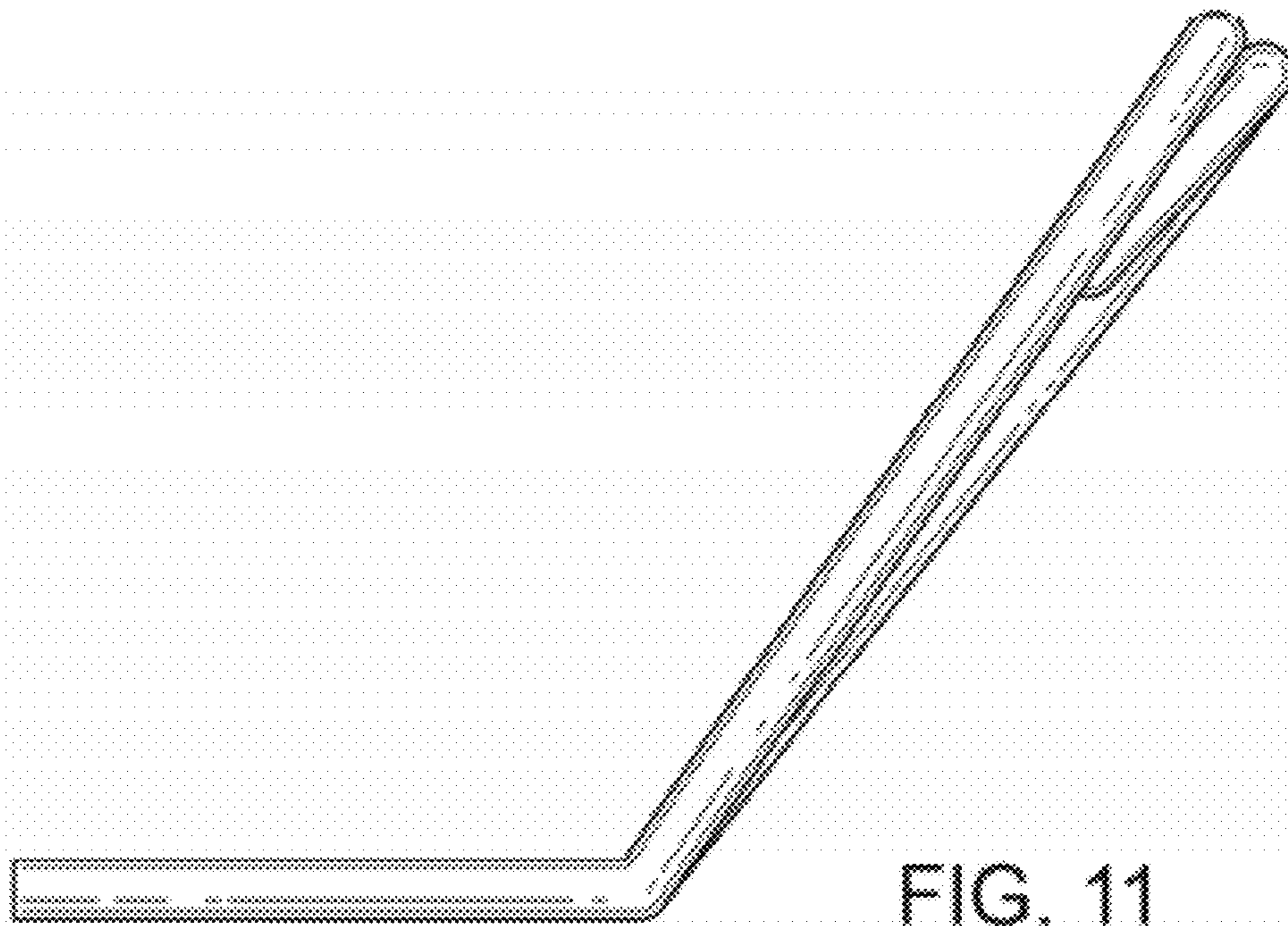

FIG. 11

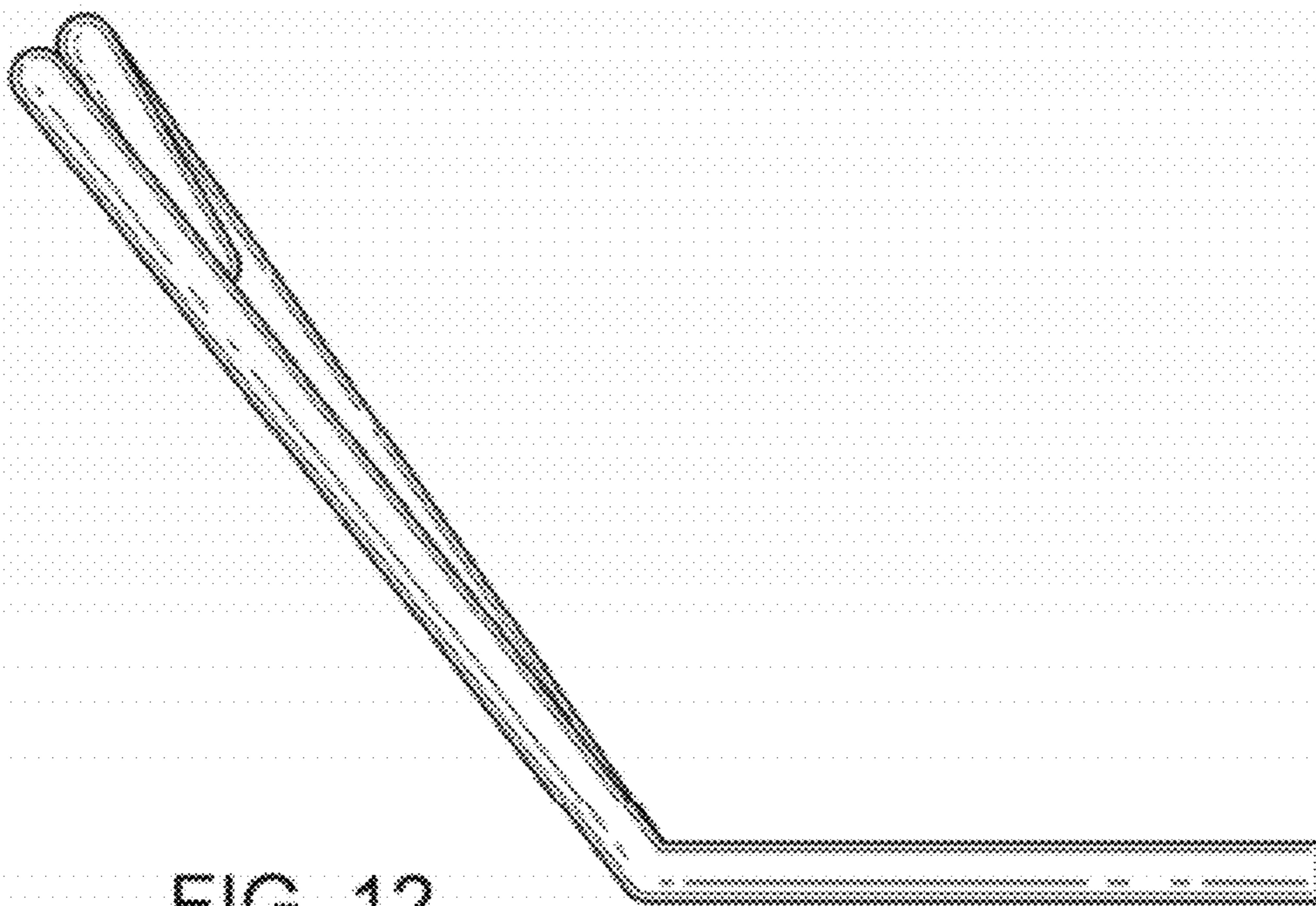

FIG. 12

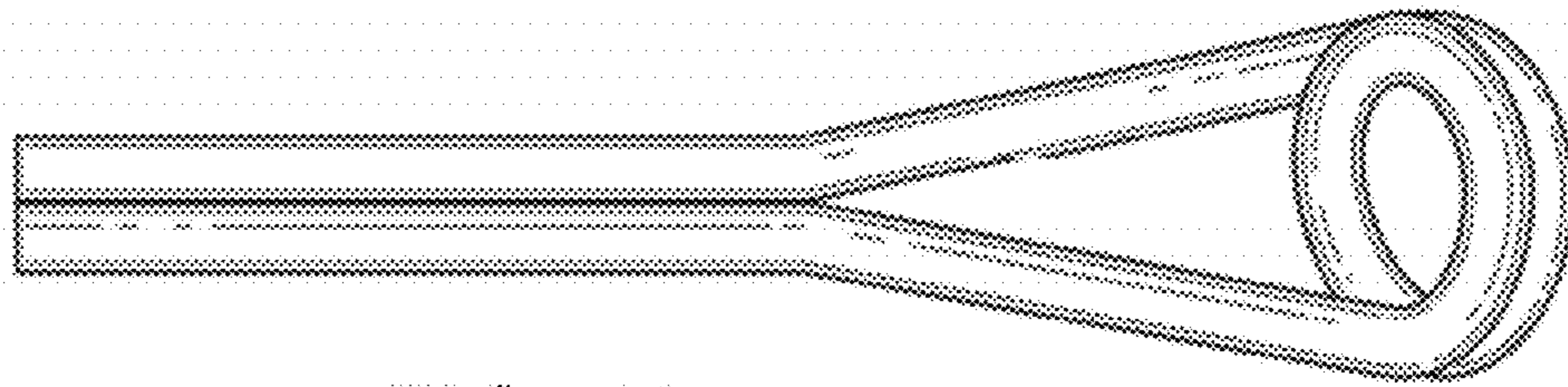

FIG. 13

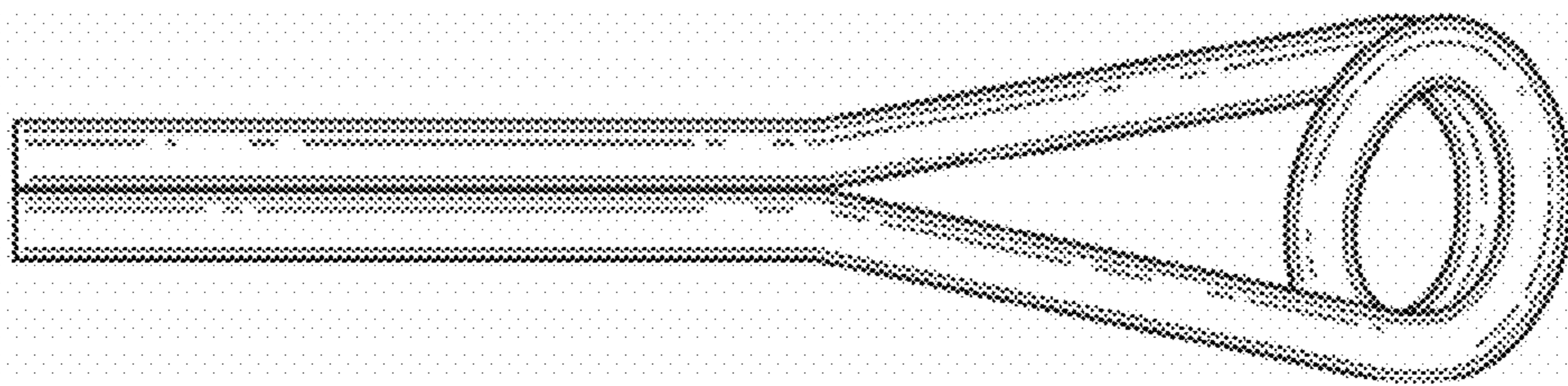

FIG. 14

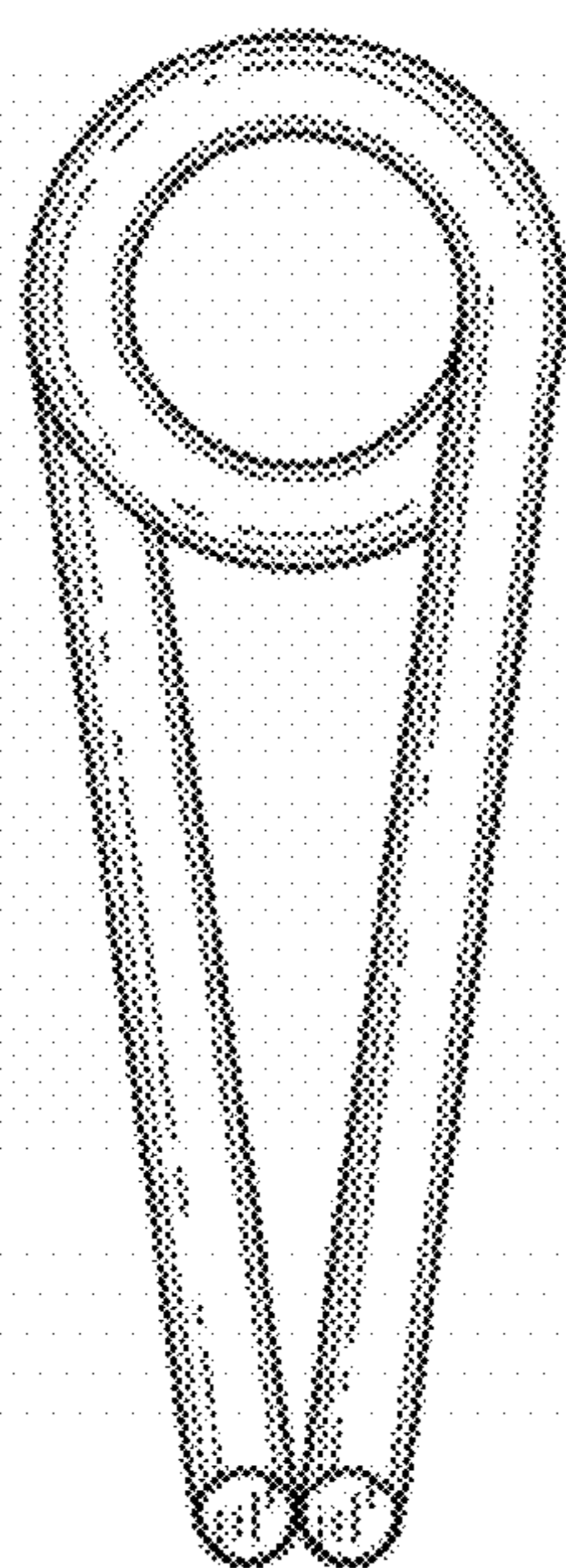

FIG. 15

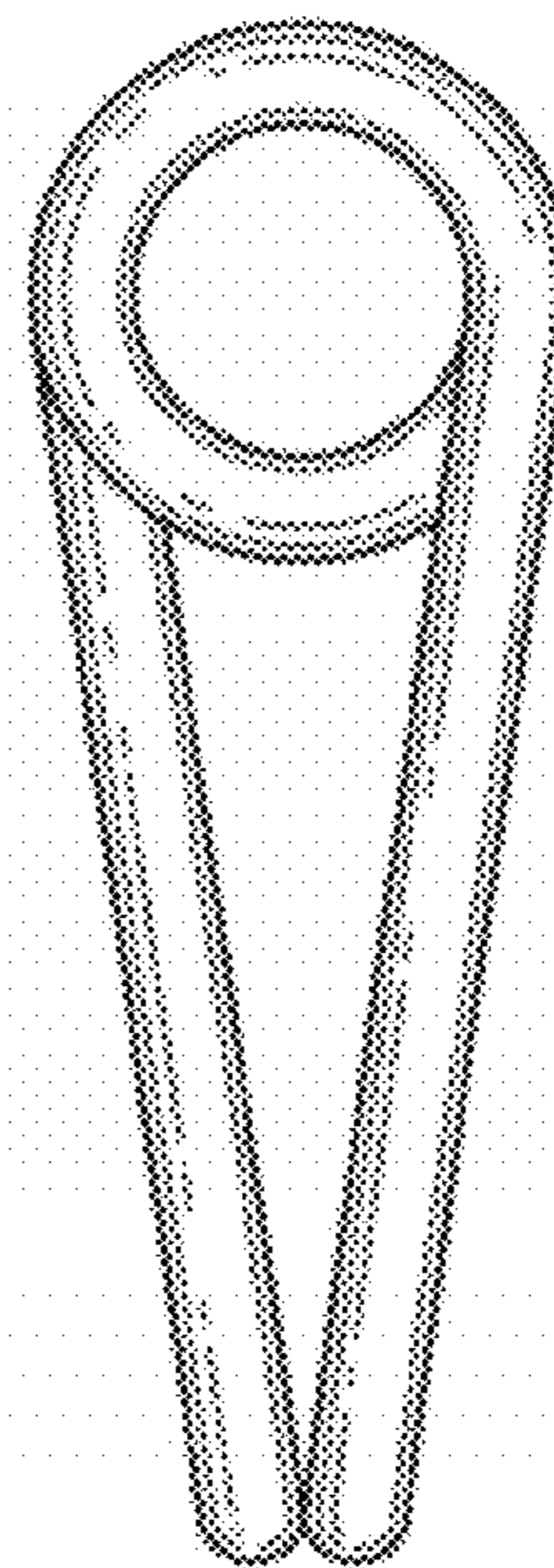

FIG. 16