



US00D677748S

(12) **United States Design Patent**
Samuels

(10) **Patent No.:** **US D677,748 S**
(45) **Date of Patent:** **** Mar. 12, 2013**

(54) **SPORTS BOARD MOUNTING SYSTEM**

(75) Inventor: **Rudy Lucas Samuels**, Mill Valley, CA
(US)

(73) Assignee: **Woodman Labs, Inc.**, San Mateo, CA
(US)

(**) Term: **14 Years**

(21) Appl. No.: **29/405,620**

(22) Filed: **Nov. 3, 2011**

(51) **LOC (9) Cl.** **21-02**

(52) **U.S. Cl.** **D21/771**

(58) **Field of Classification Search** D21/769-770,
D21/801, 803, 809; 114/253, 345-346; 441/35,
441/66, 74, 40-42, 129-132; 472/128-129;
D12/5, 6, 316; D16/242

See application file for complete search history.

(56) **References Cited**

U.S. PATENT DOCUMENTS

D502,522 S *	3/2005	Sperafico	D21/771
7,117,699 B2 *	10/2006	Bistline	70/58
D557,320 S *	12/2007	Fisher et al.	D16/242
D557,321 S *	12/2007	Fisher et al.	D16/242
D630,238 S *	1/2011	Fukuma et al.	D16/242
D643,868 S *	8/2011	van Herpen	D16/242
8,014,656 B2	9/2011	Woodman		
8,150,248 B1 *	4/2012	Woodman	396/25
D660,393 S *	5/2012	Bradley et al.	D21/771
D661,718 S *	6/2012	Tang	D16/202
D663,000 S *	7/2012	Trotter	D21/771

* cited by examiner

Primary Examiner — Zenia Bennett

(74) *Attorney, Agent, or Firm* — Fenwick & West LLP

(57) **CLAIM**

The ornamental design for a sports board mounting system, as shown and described.

DESCRIPTION

This application is related to U.S. Pat. No. 8,014,656, filed Jul. 7, 2009, the contents of which are incorporated by reference herein in its entirety.

FIG. 1 is a front top left perspective view of a sports board mounting system;

FIG. 2 is a front top right perspective view thereof;

FIG. 3 is a back top right perspective view thereof;

FIG. 4 is a back top left perspective view thereof;

FIG. 5 is a front view thereof;

FIG. 6 is a back view thereof;

FIG. 7 is a right view thereof;

FIG. 8 is a left view thereof;

FIG. 9 is a top view thereof;

FIG. 10 is a bottom view thereof;

FIG. 11 is a front bottom perspective view thereof; and,

FIG. 12 is a front top left perspective view thereof.

The broken lines in the drawing are for illustrative purposes only and form no part of the claimed design.

1 Claim, 12 Drawing Sheets

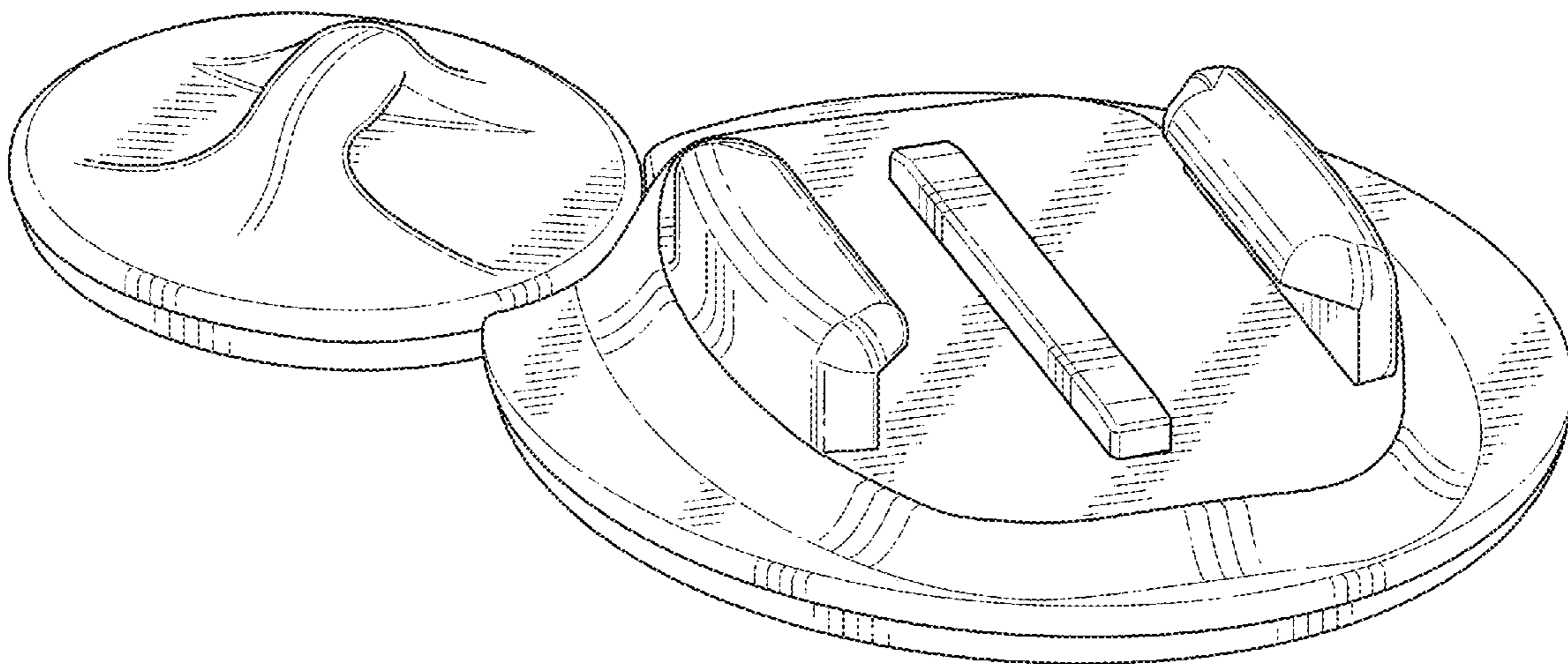

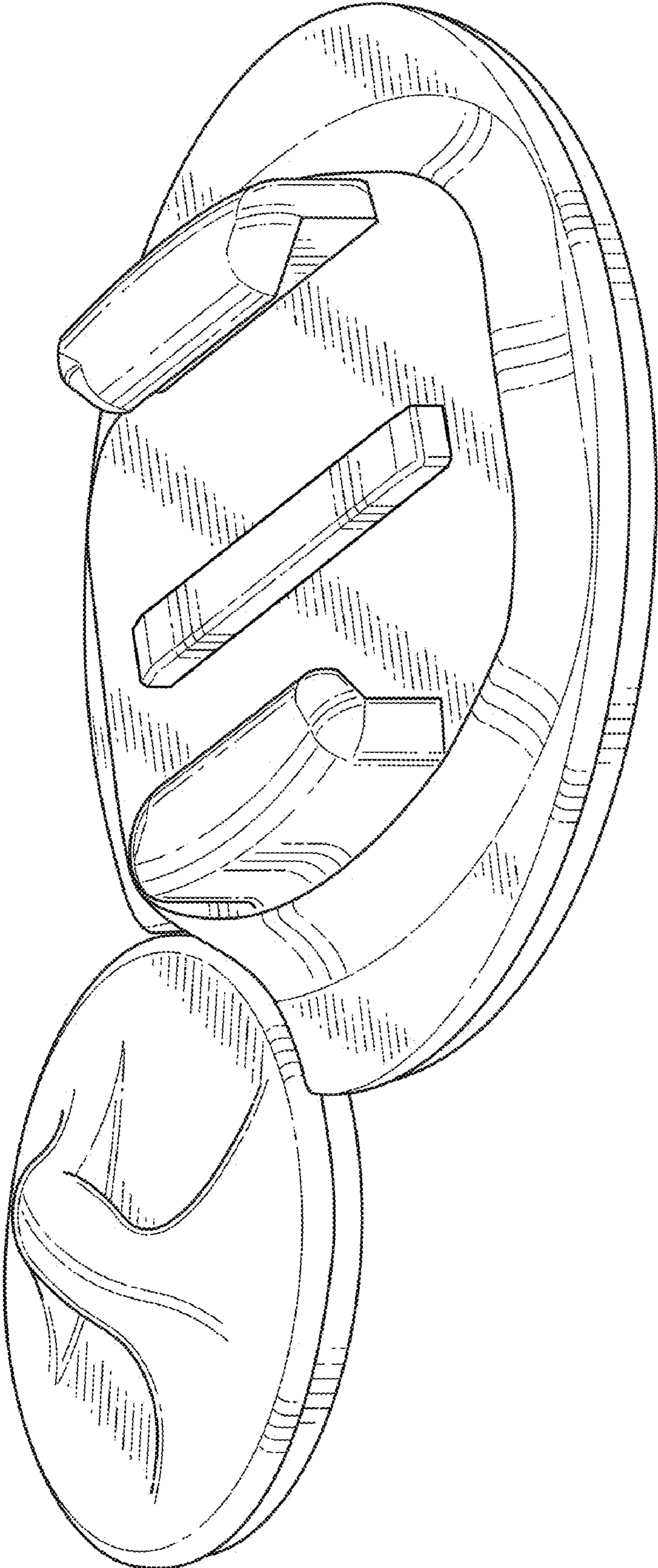

FIG. 1

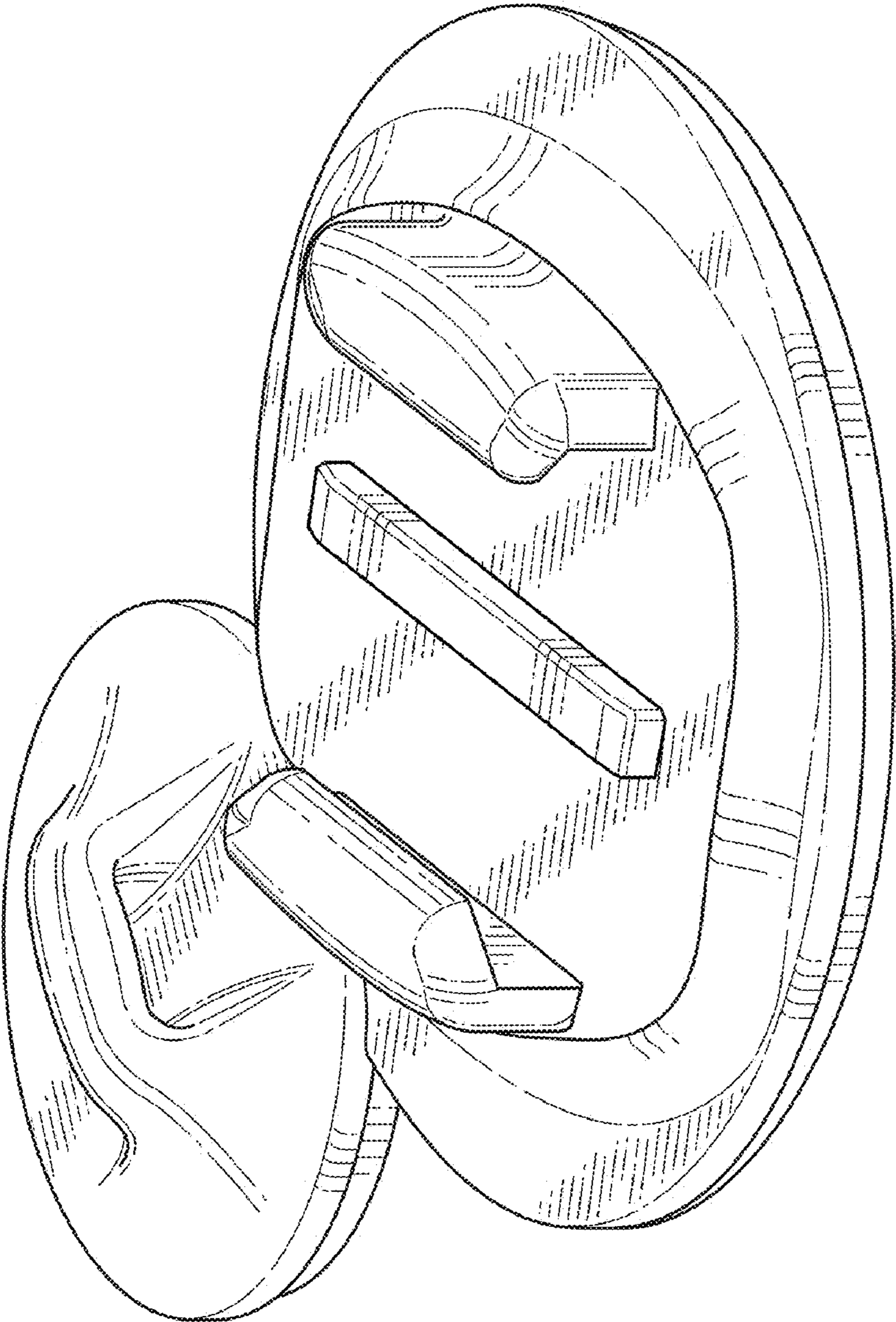

FIG. 2

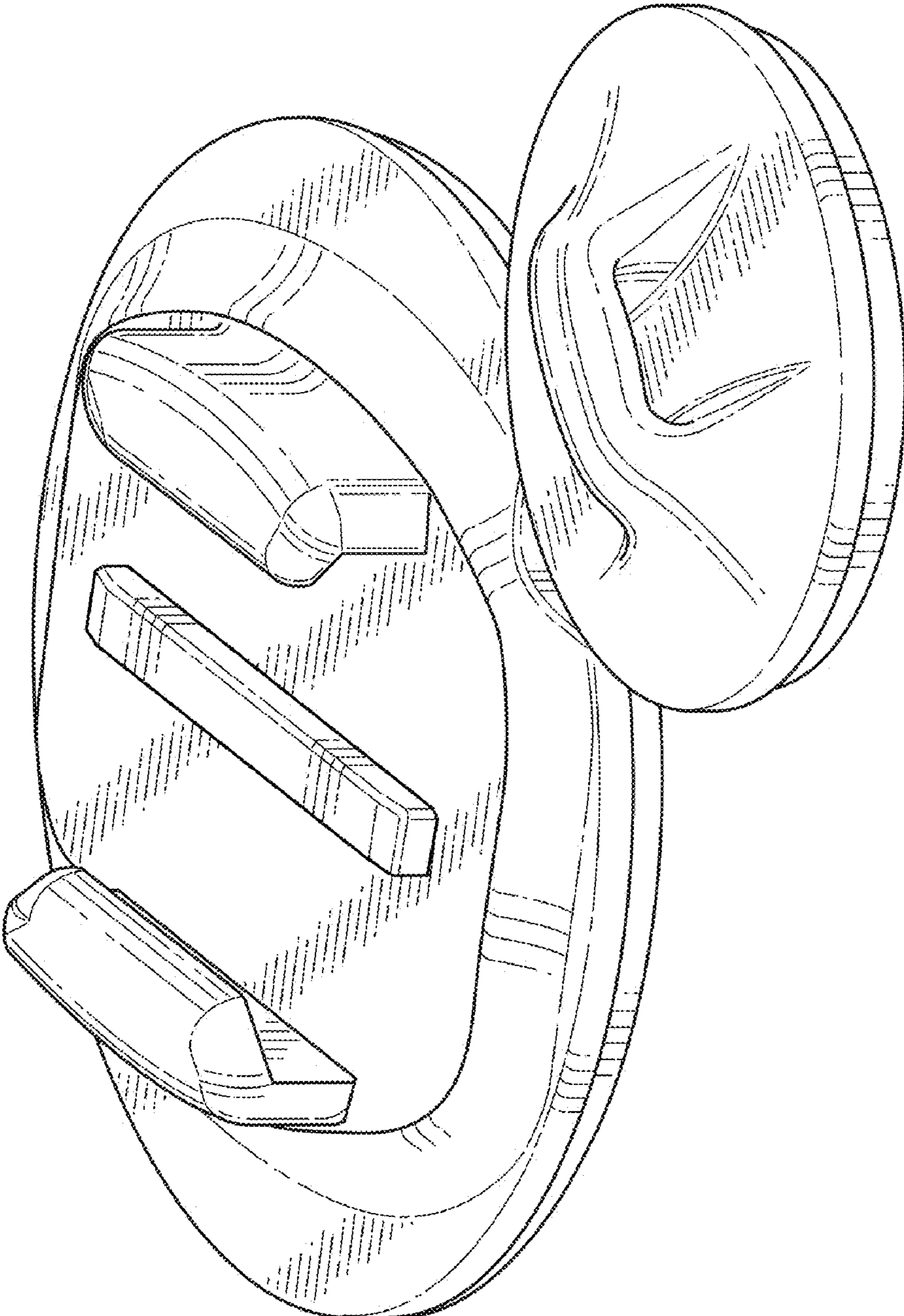

FIG. 3

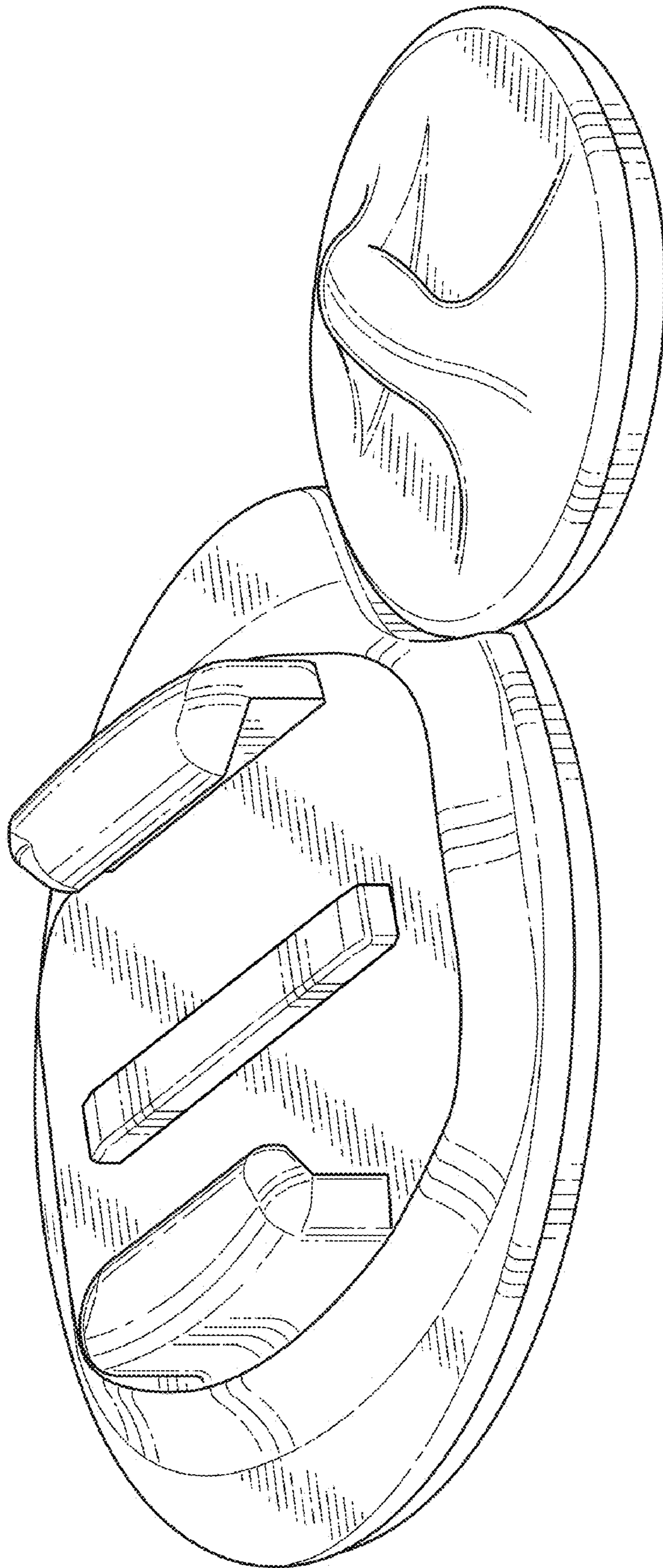

FIG. 4

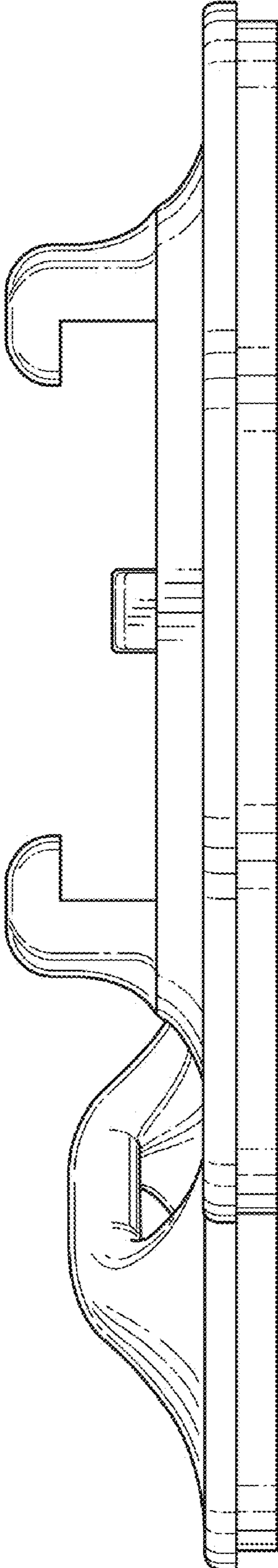

FIG. 5

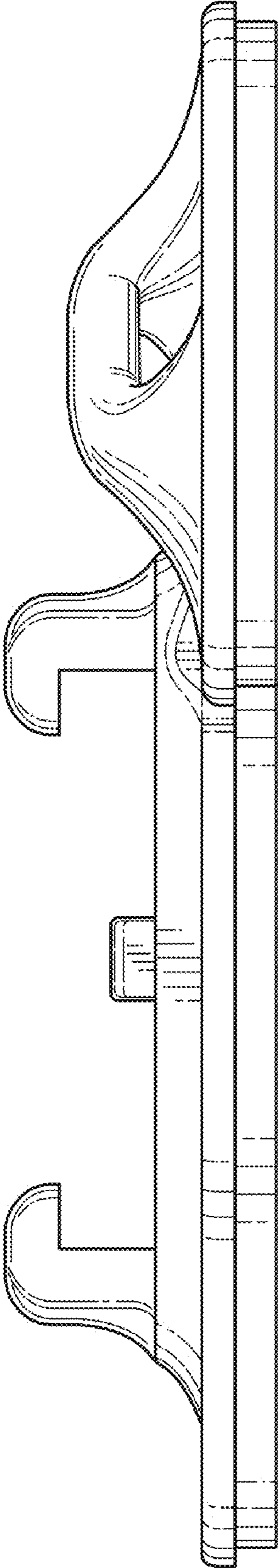

FIG. 6

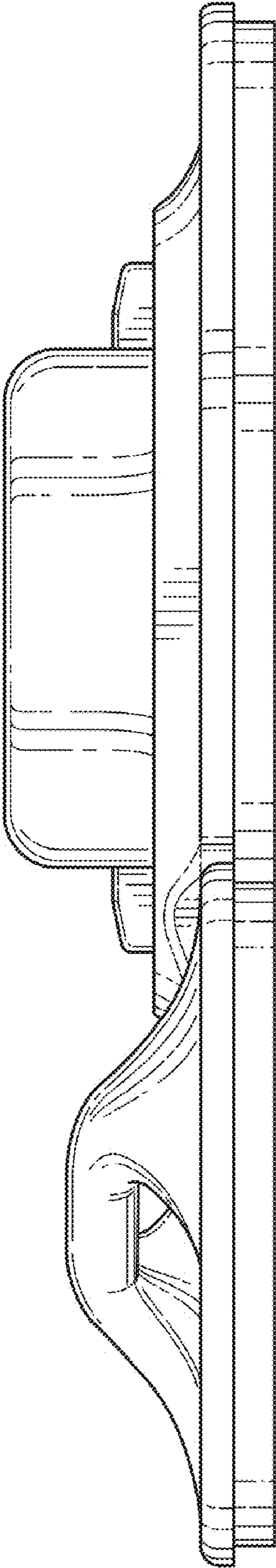

FIG. 7

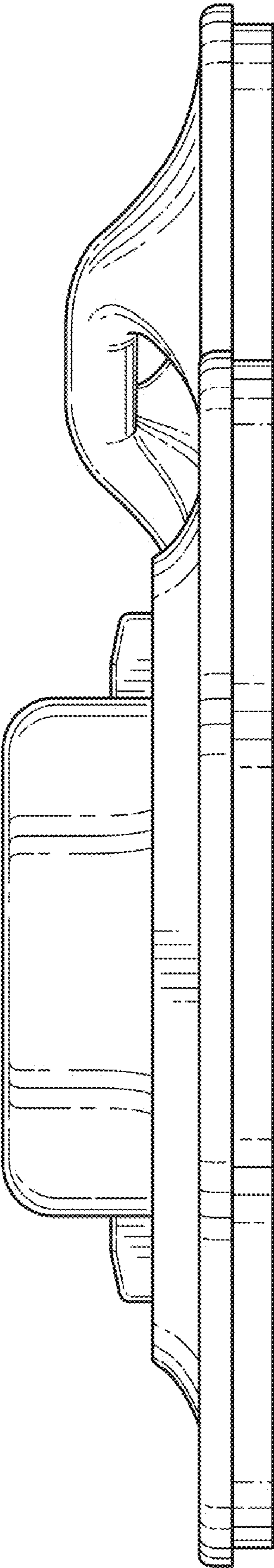

FIG. 8

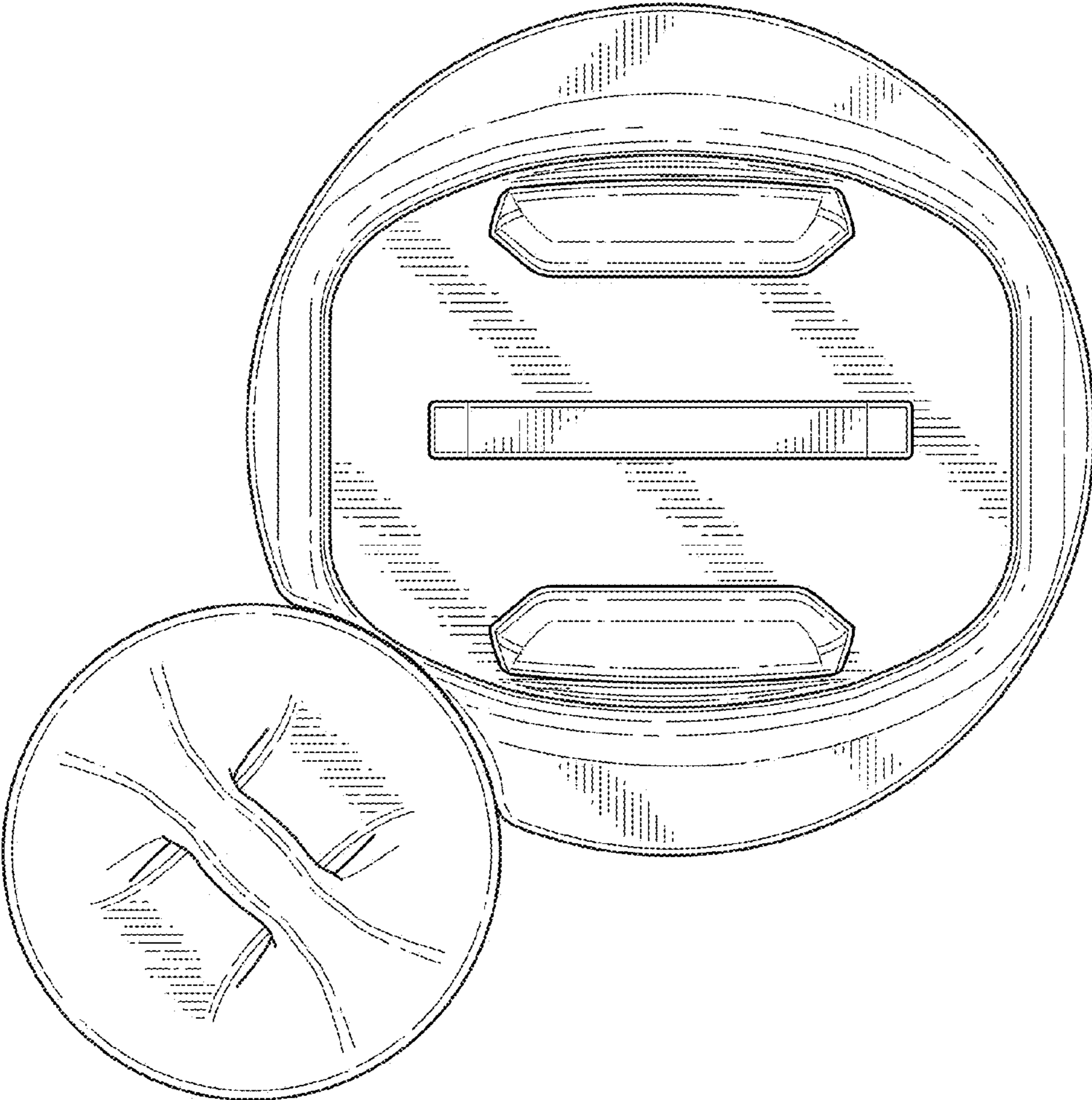

FIG. 9

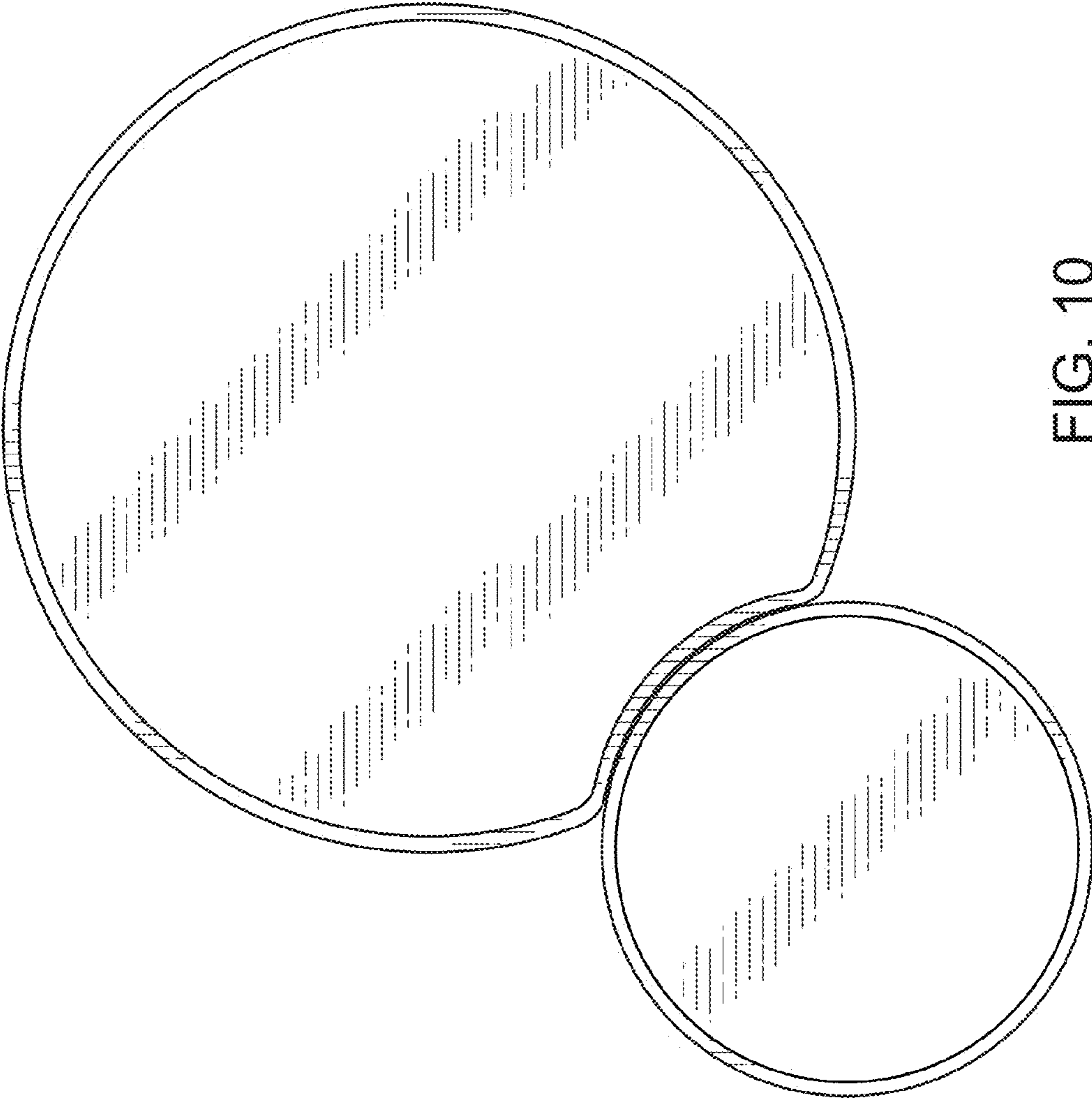

FIG. 10

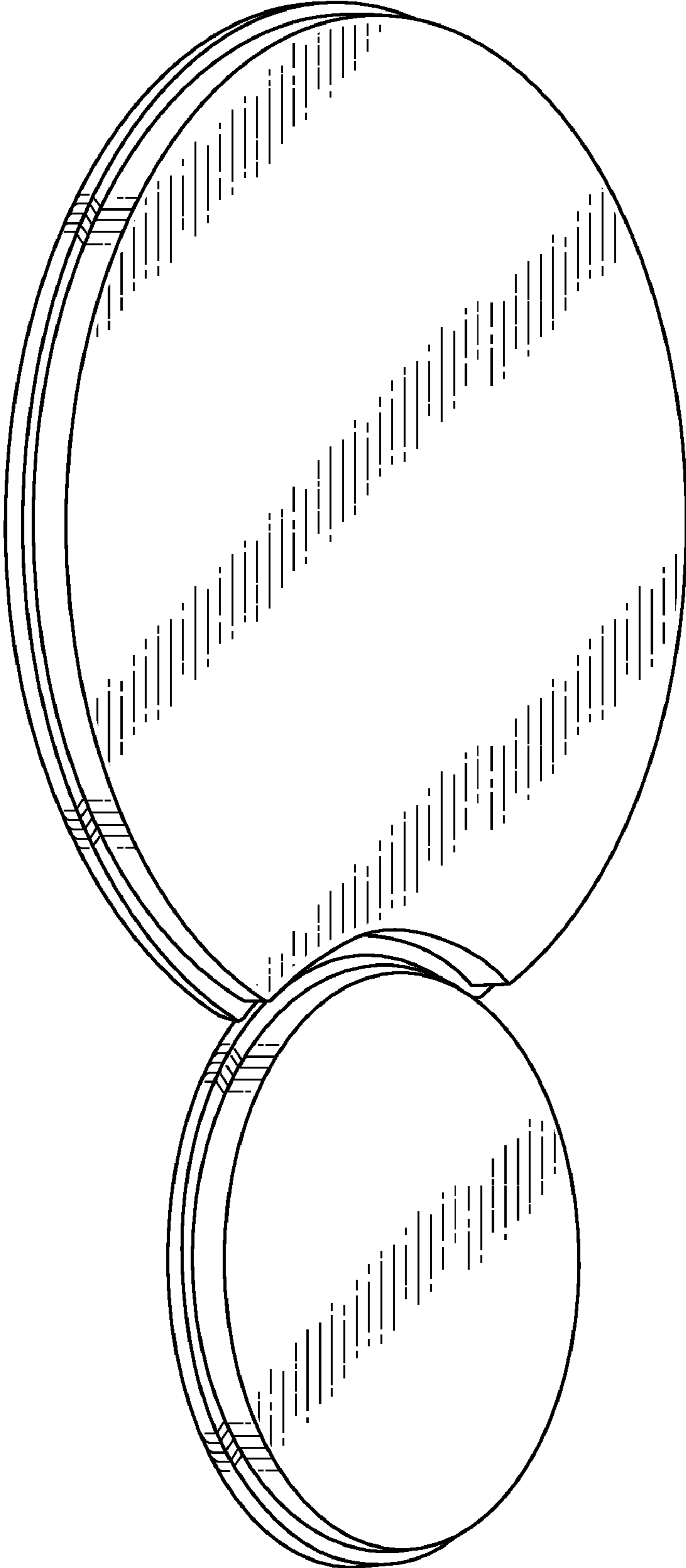

FIG. 11

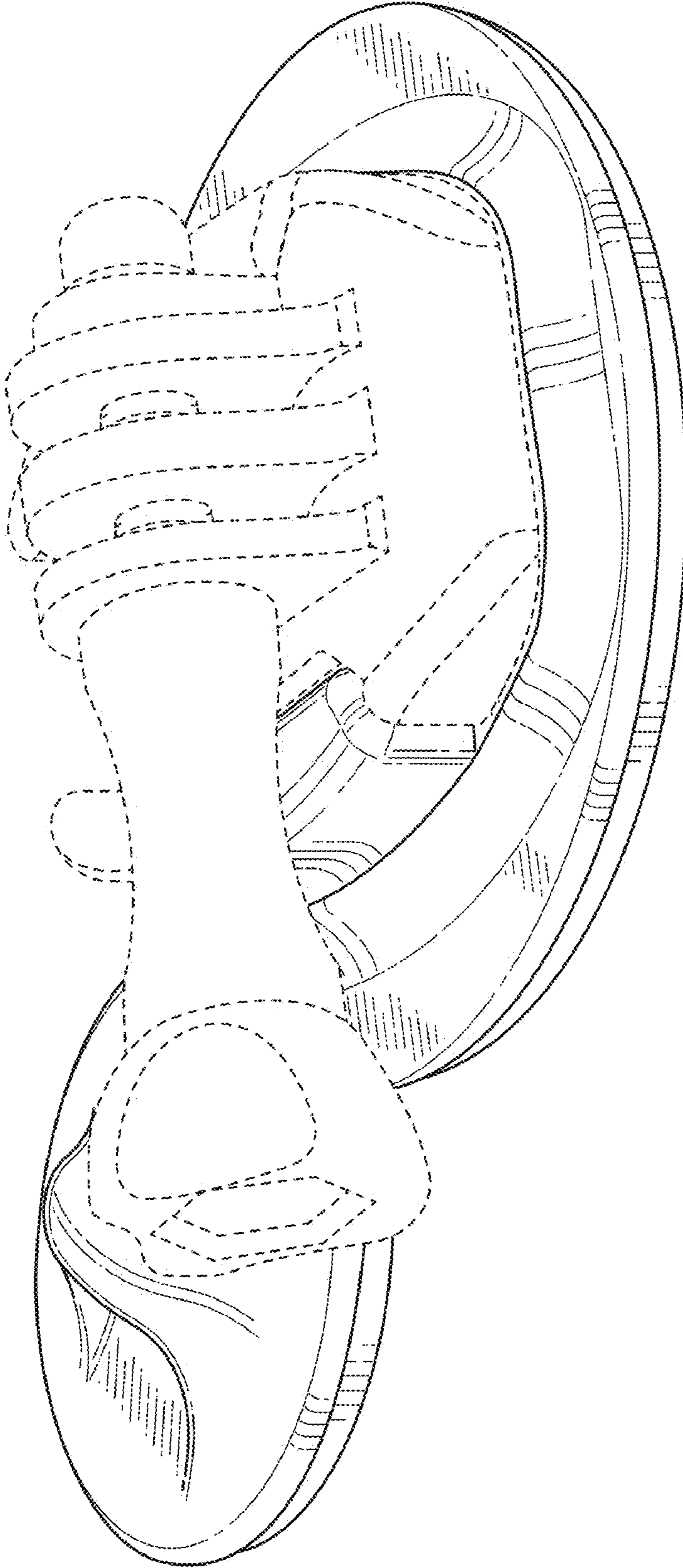

FIG. 12