



US00D677720S

(12) **United States Design Patent**  
**Tanaka et al.**

(10) **Patent No.:** **US D677,720 S**  
(45) **Date of Patent:** **\*\* Mar. 12, 2013**

(54) **LABEL PRINTER**

(75) Inventors: **Hiroaki Tanaka**, Tama (JP); **Tetsu Nakayama**, Matsumoto (JP)

(73) Assignee: **Seiko Epson Corporation**, Tokyo (JP)

(\*\*) Term: **14 Years**

(21) Appl. No.: **29/413,857**

(22) Filed: **Feb. 22, 2012**

(30) **Foreign Application Priority Data**

Dec. 21, 2011 (JP) ..... 2011-029625

(51) **LOC (9) Cl.** ..... **14-02**

(52) **U.S. Cl.** ..... **D18/55**

(58) **Field of Classification Search** ..... D18/19,  
D18/36-38, 50, 52, 54, 54.1, 55; D14/420-425,  
D14/462-470; 400/613, 613.1-613.4, 690.1-690.4,  
400/691-694

See application file for complete search history.

(56) **References Cited**

**U.S. PATENT DOCUMENTS**

4,904,100	A *	2/1990	Enix	.....	400/613
D313,988	S *	1/1991	Watanabe	.....	D14/462
D324,234	S *	2/1992	Tanaka	.....	D18/54
D376,384	S *	12/1996	Woei-Fang	.....	D18/55
D386,515	S *	11/1997	Sommerville et al.	.....	D18/54.1
D409,232	S *	5/1999	Kim	.....	D18/50

6,003,008	A *	12/1999	Postrel et al.	.....	705/4
D430,199	S *	8/2000	Petteruti et al.	.....	D18/50
D431,596	S *	10/2000	Berger	.....	D18/50
D509,845	S *	9/2005	Miyauchi et al.	.....	D18/50
D515,132	S *	2/2006	Todd	.....	D18/55
D516,120	S *	2/2006	Yamano et al.	.....	D18/55
D527,413	S *	8/2006	Delaney et al.	.....	D18/50
D532,038	S *	11/2006	Hutchinson	.....	D18/50
7,306,386	B2 *	12/2007	Lyman et al.	.....	400/692
D607,926	S *	1/2010	Miyauchi et al.	.....	D18/55
D615,125	S *	5/2010	Hyakumoto et al.	.....	D18/50
D643,875	S *	8/2011	Suzuki et al.	.....	D18/55
D654,949	S *	2/2012	Preliasco et al.	.....	D18/14

\* cited by examiner

*Primary Examiner* — Cathy A MacCormac

(57) **CLAIM**

The ornamental design for a label printer, as shown.

**DESCRIPTION**

FIG. 1 is a front, top and right side perspective view of a label printer showing our new design;  
FIG. 2 is a rear, top and right side perspective view thereof;  
FIG. 3 is a front elevational view thereof;  
FIG. 4 is a rear elevational view thereof;  
FIG. 5 is a top plan view thereof;  
FIG. 6 is a bottom plan view thereof;  
FIG. 7 is a right side elevational view thereof; and,  
FIG. 8 is a left side elevational view thereof.

**1 Claim, 8 Drawing Sheets**

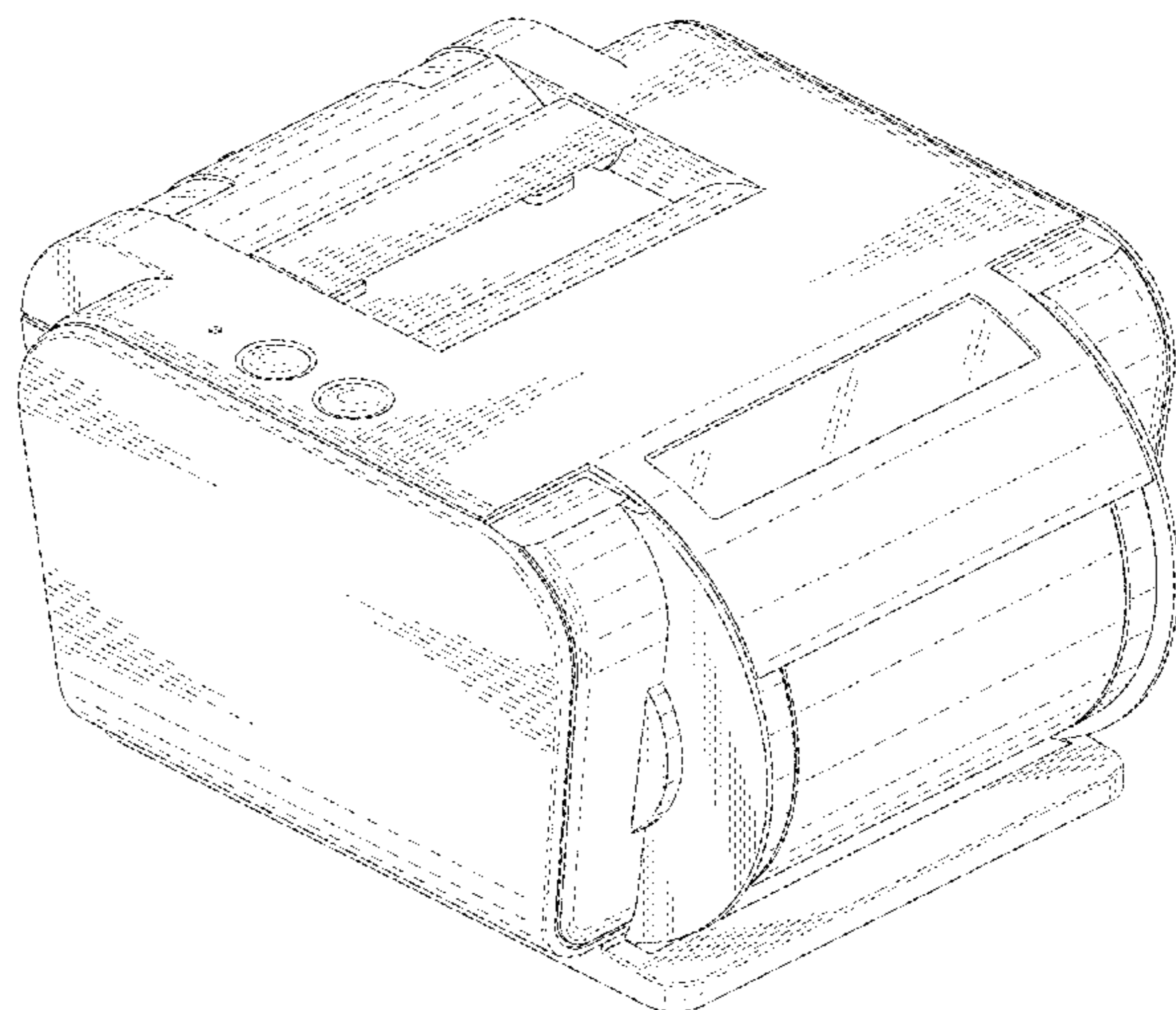
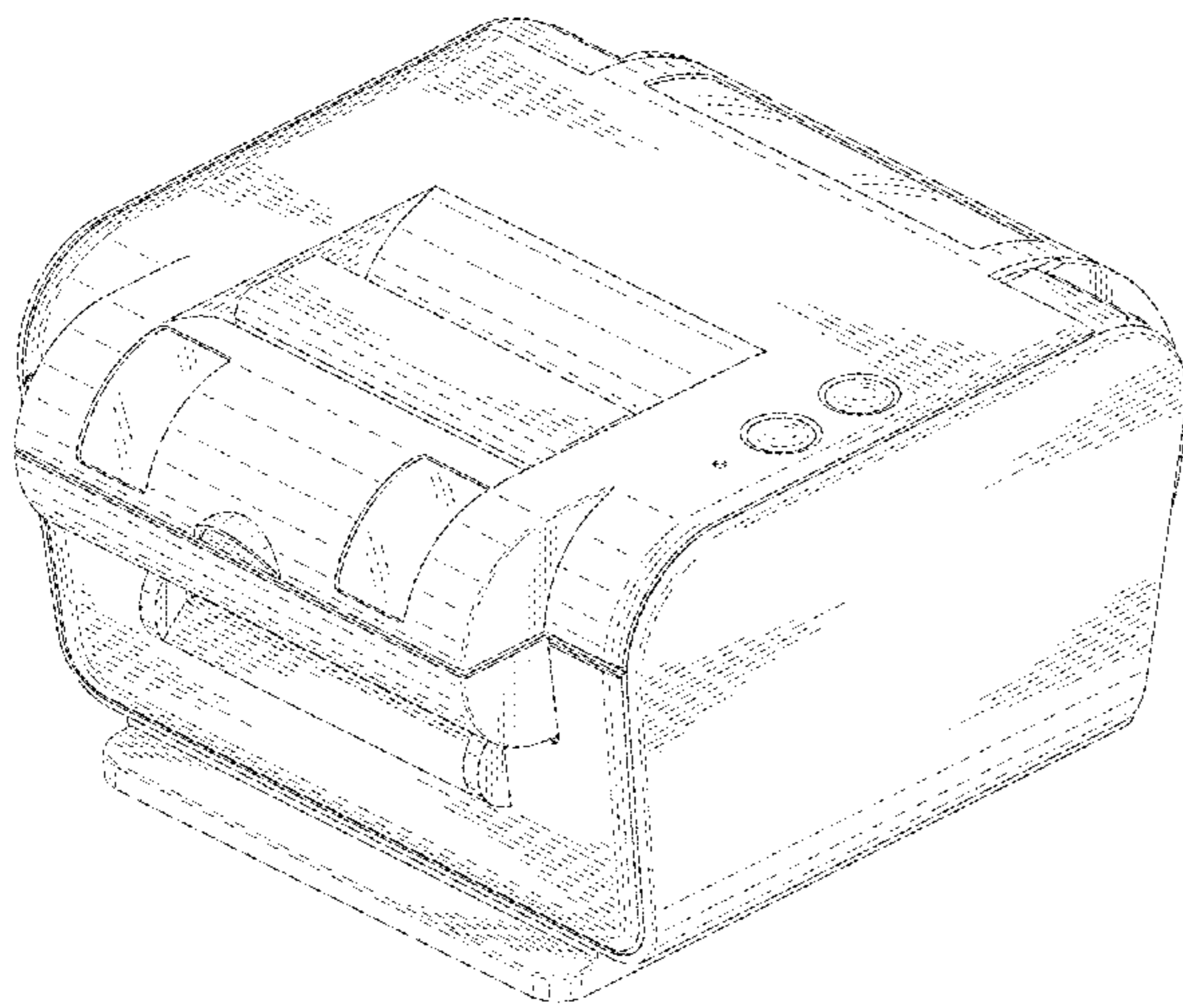

**FIG. 1**

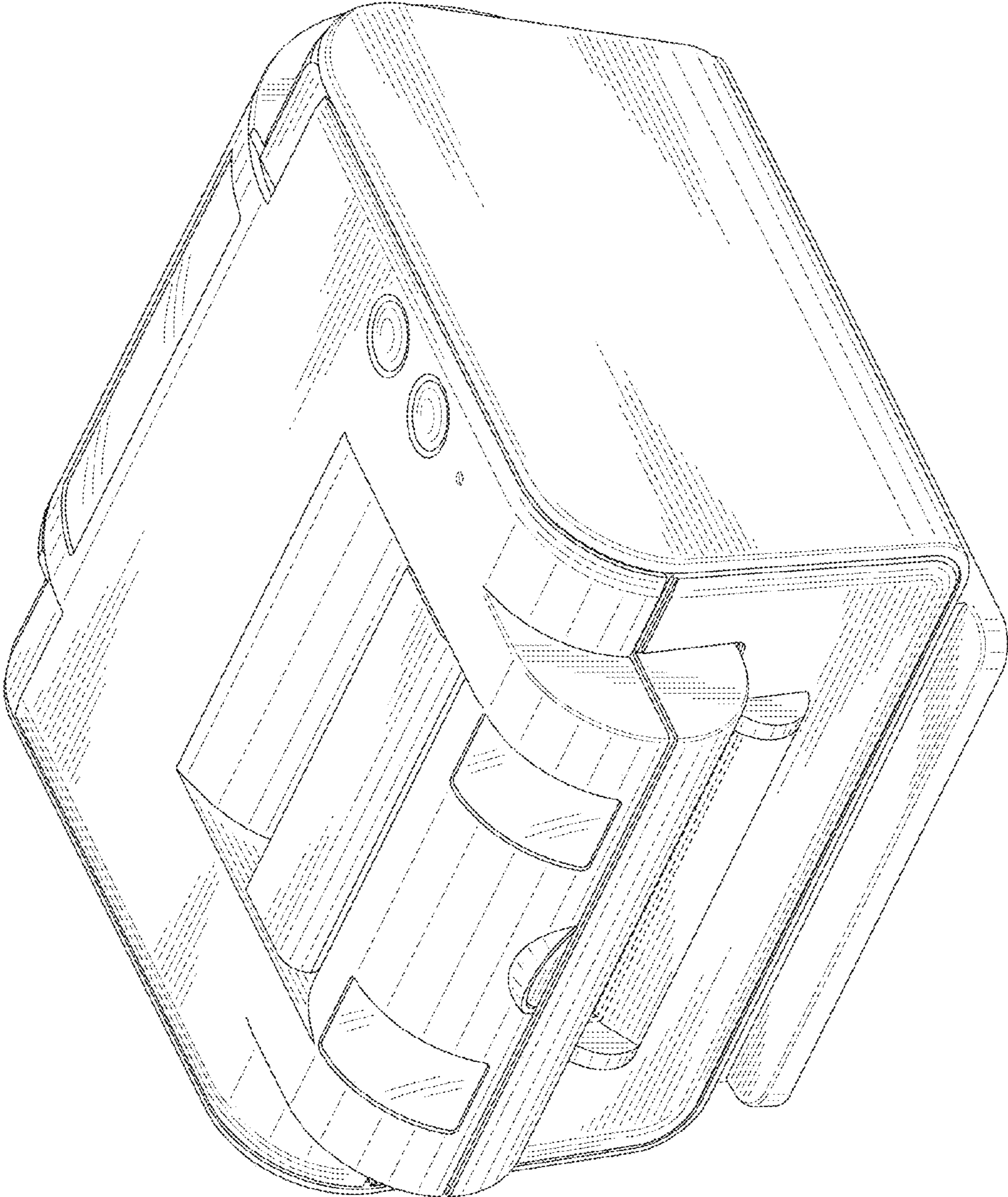

**FIG. 2**

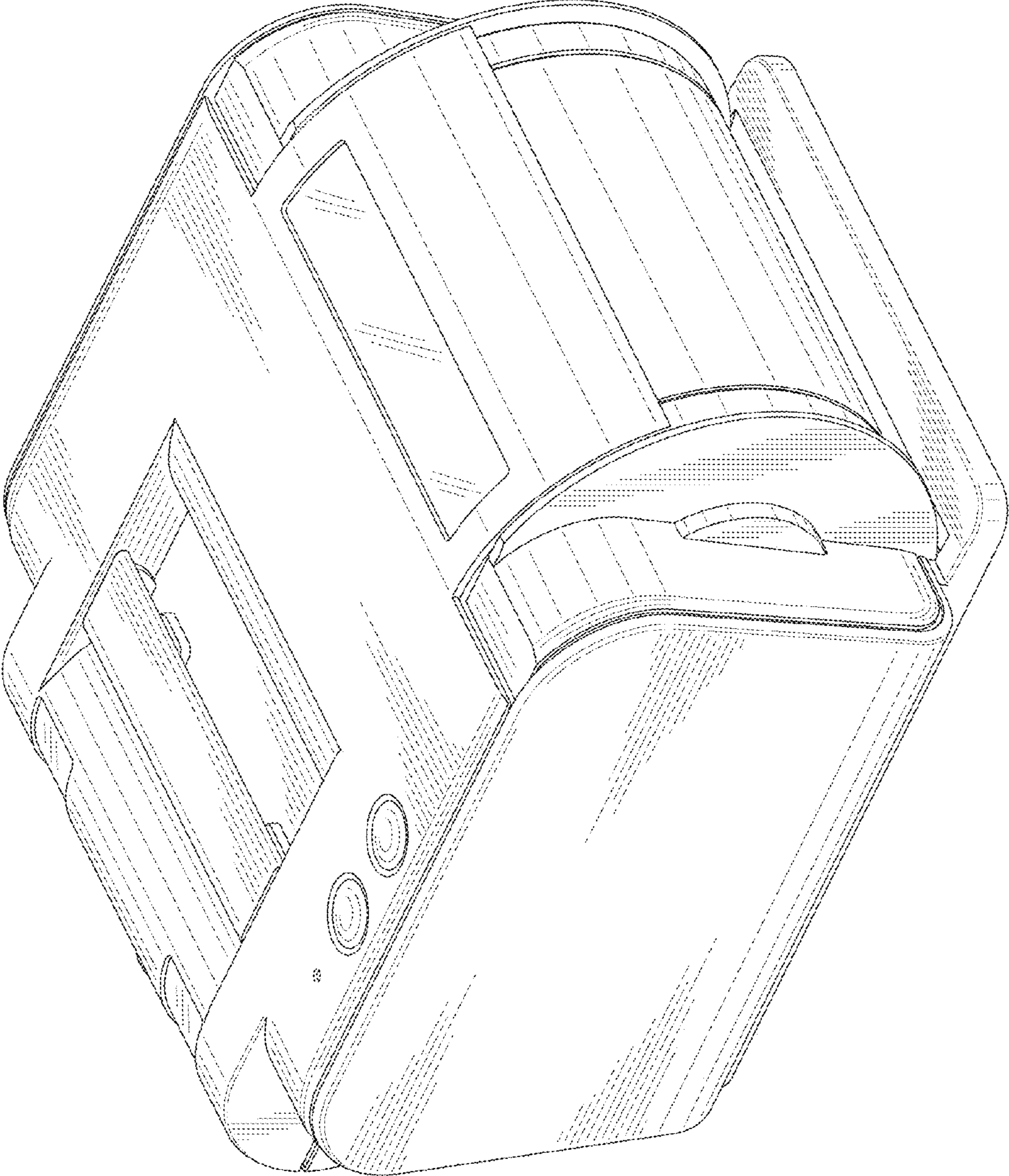

**FIG. 3**

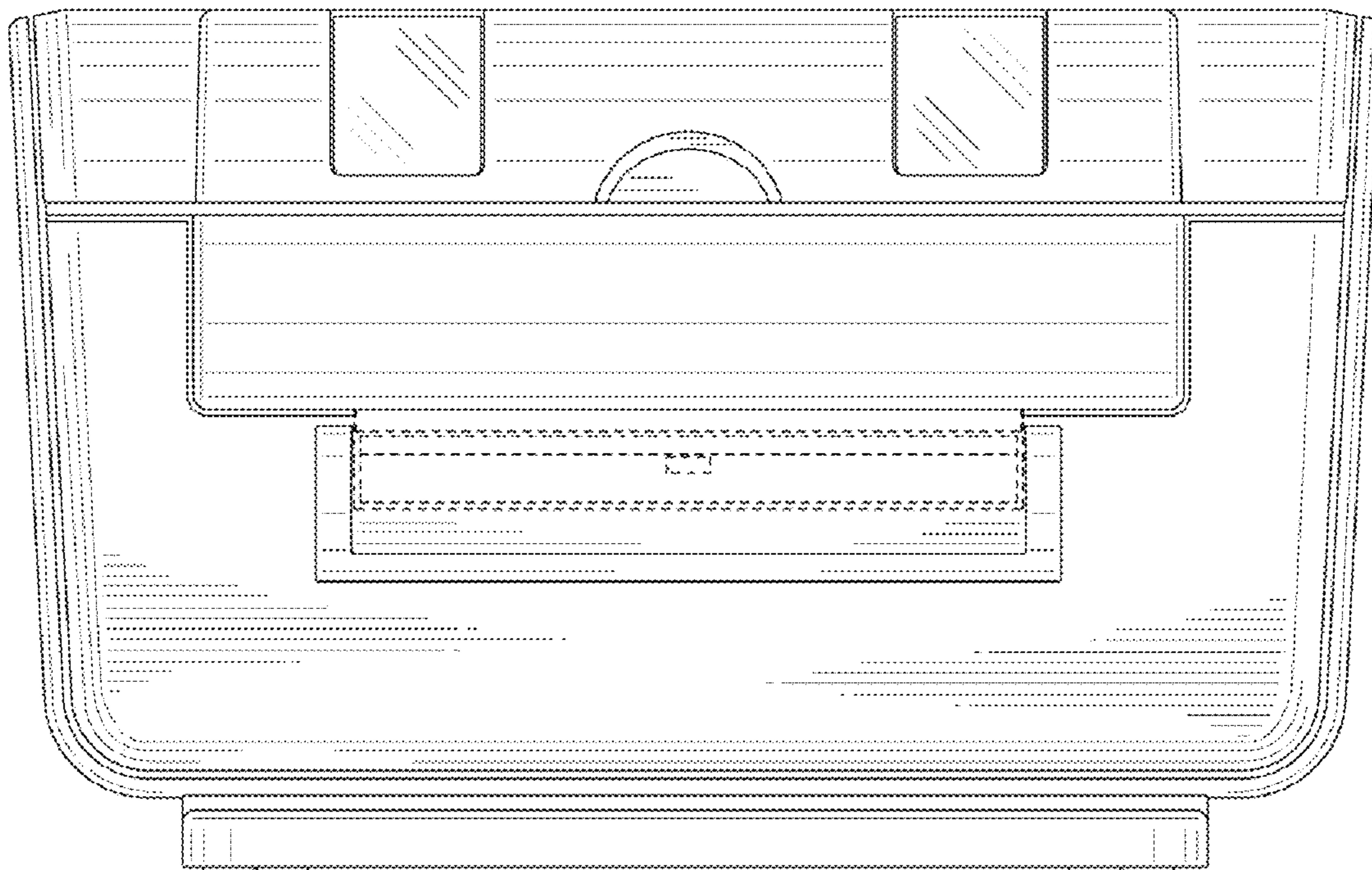

**FIG. 4**

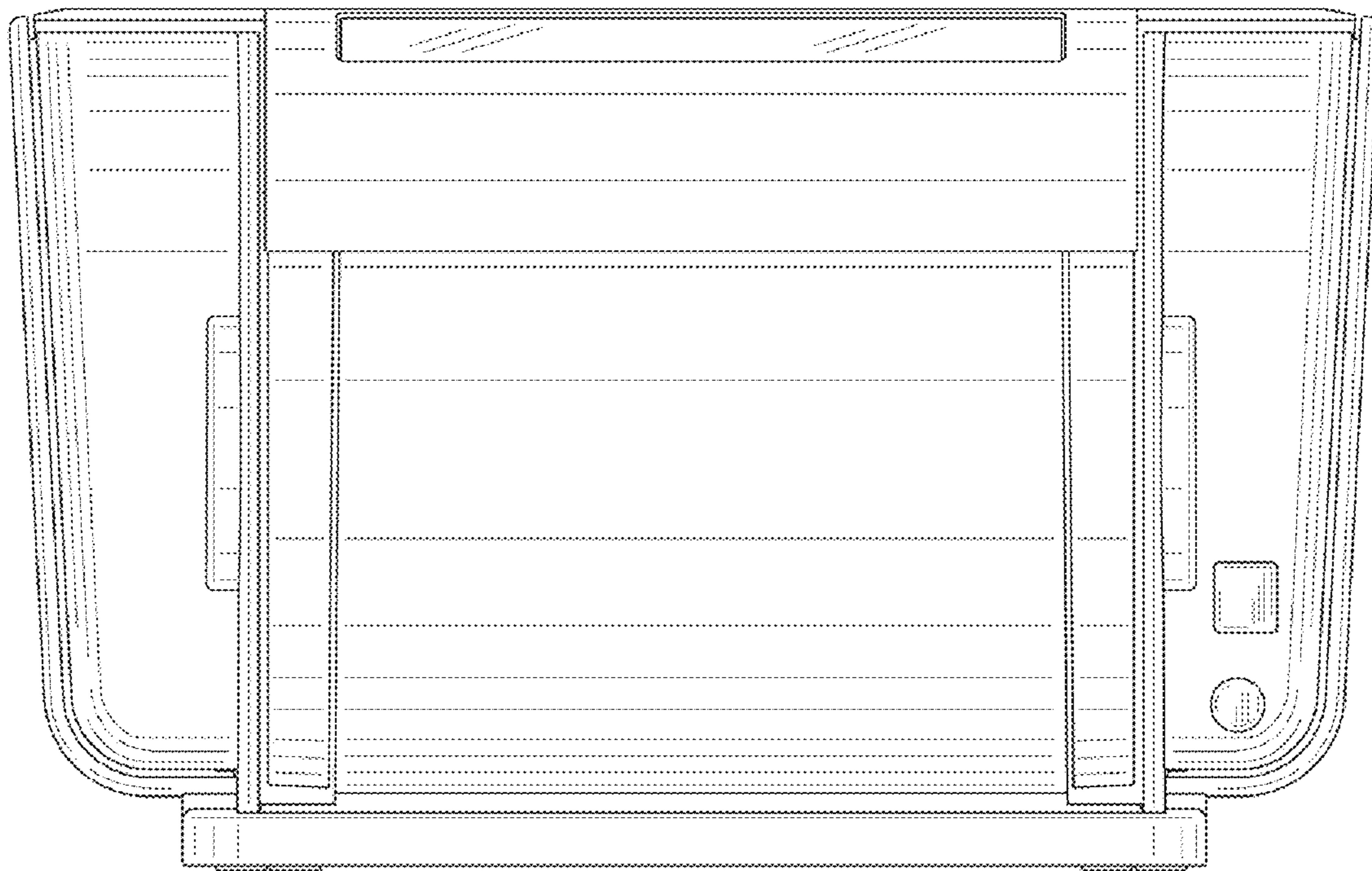

**FIG. 5**

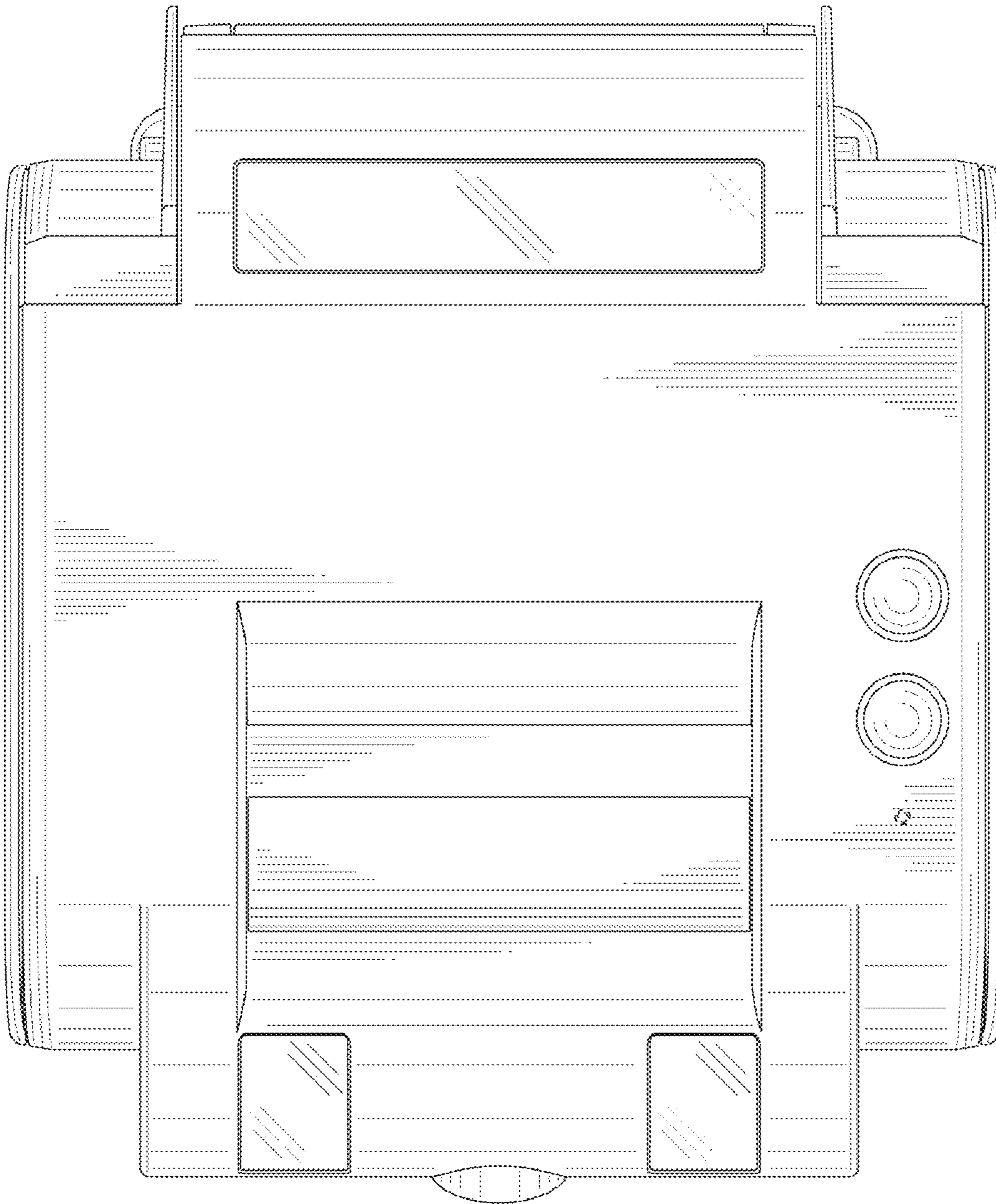

**FIG. 6**

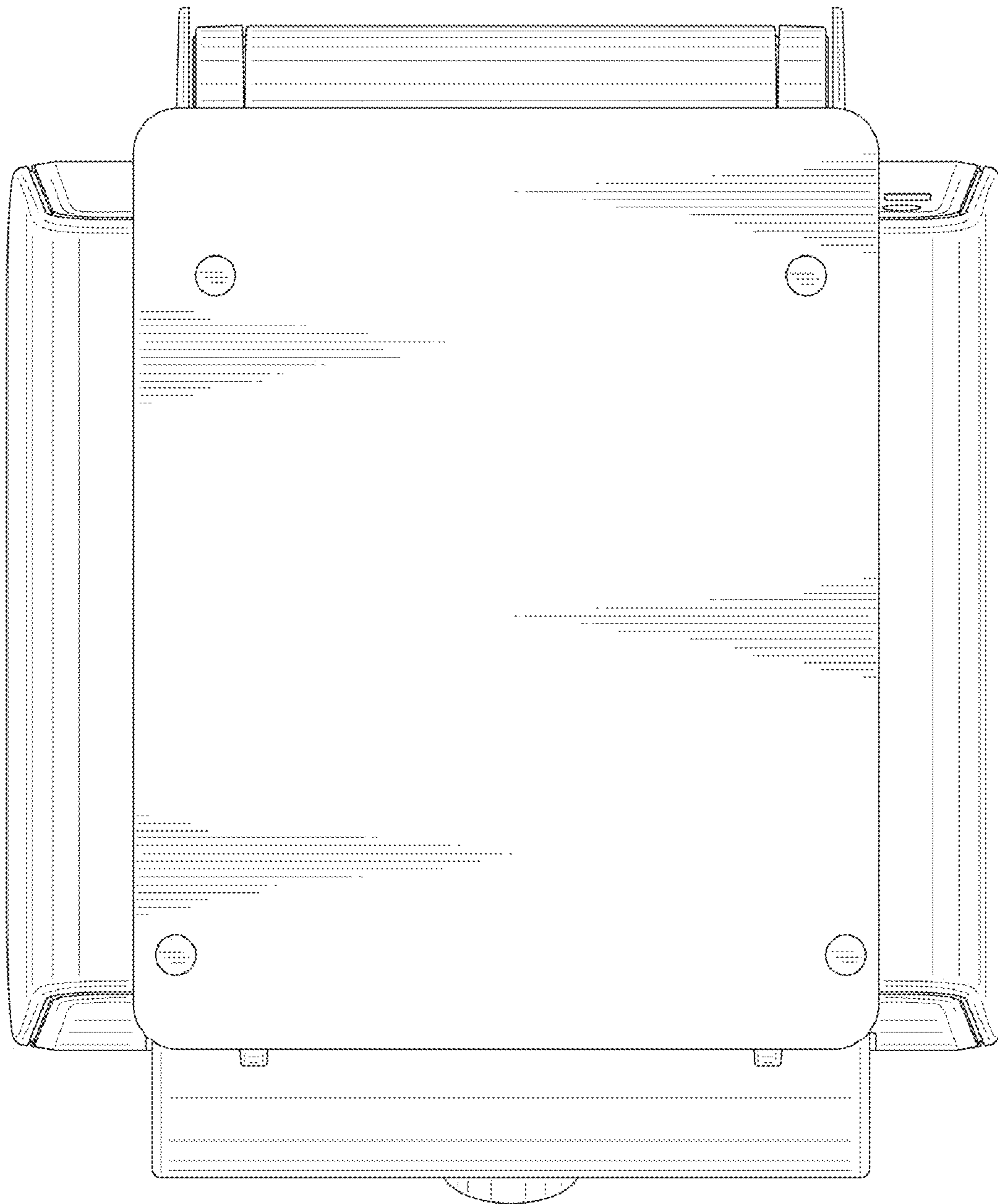

**FIG. 7**

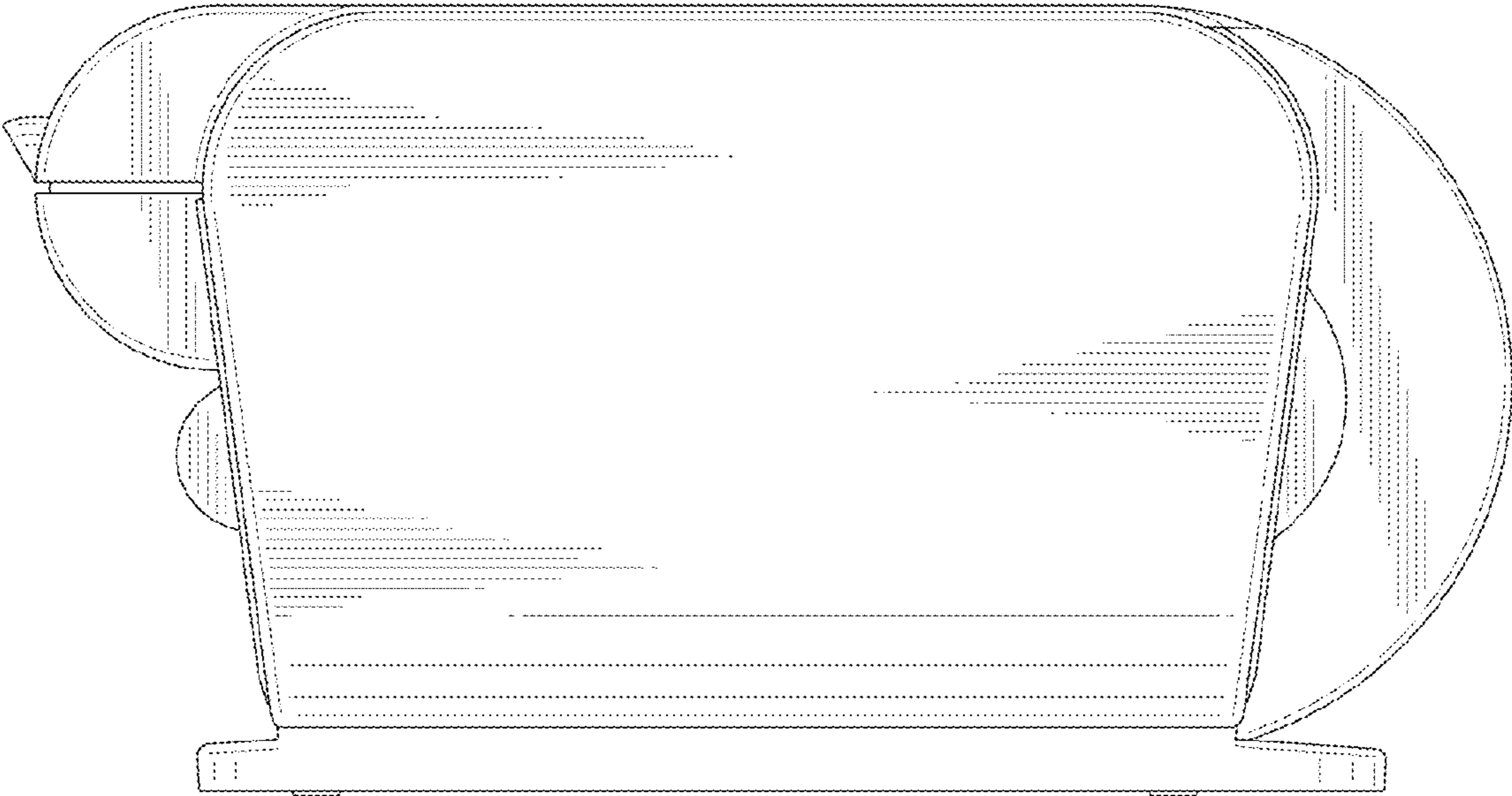



**FIG. 8**

