



US00D677713S

(12) **United States Design Patent**
Blanc

(10) **Patent No.:** **US D677,713 S**
(45) **Date of Patent:** **** Mar. 12, 2013**

(54) **GUITAR HEAD**

(75) Inventor: **Patrice Blanc**, Nantes (FR)

(73) Assignee: **Woodbrass.com**, Paris (FR)

(**) Term: **14 Years**

(21) Appl. No.: **29/427,086**

(22) Filed: **Jul. 13, 2012**

(30) **Foreign Application Priority Data**

Jan. 18, 2012 (FR) 2012 0268

(51) **LOC (9) Cl.** **17-03**

(52) **U.S. Cl.** **D17/20**

(58) **Field of Classification Search** D17/14,
D17/18, 19, 20; 84/173, 267, 290-293

See application file for complete search history.

(56) **References Cited**

U.S. PATENT DOCUMENTS

D268,685 S * 4/1983 Seshimoto D17/20
D313,609 S * 1/1991 Mulroy, Jr. D17/20
D314,784 S * 2/1991 Powers D17/20

D349,720 S * 8/1994 Kim D17/20
5,600,078 A * 2/1997 Edwards 84/307
5,889,221 A * 3/1999 Dejima 84/291
D416,935 S * 11/1999 DeCola D17/20
5,990,396 A * 11/1999 Lasner 84/293
D516,608 S * 3/2006 Butler et al. D17/20
D572,302 S * 7/2008 Peavey D17/20
D643,460 S * 8/2011 Barkdull D17/20

* cited by examiner

Primary Examiner — Rashida Johnson

(74) *Attorney, Agent, or Firm* — Norris McLaughlin & Marcus, P.A.

(57) **CLAIM**

The ornamental design for an guitar head, as shown and described.

DESCRIPTION

FIG. 1 is a front, left perspective view thereof;
FIG. 2 is a front elevational view thereof;
FIG. 3 is a rear elevational view thereof;
FIG. 4 is a left side view thereof;
FIG. 5 is right side view thereof; and,
FIG. 6 is a top view thereof.

1 Claim, 5 Drawing Sheets

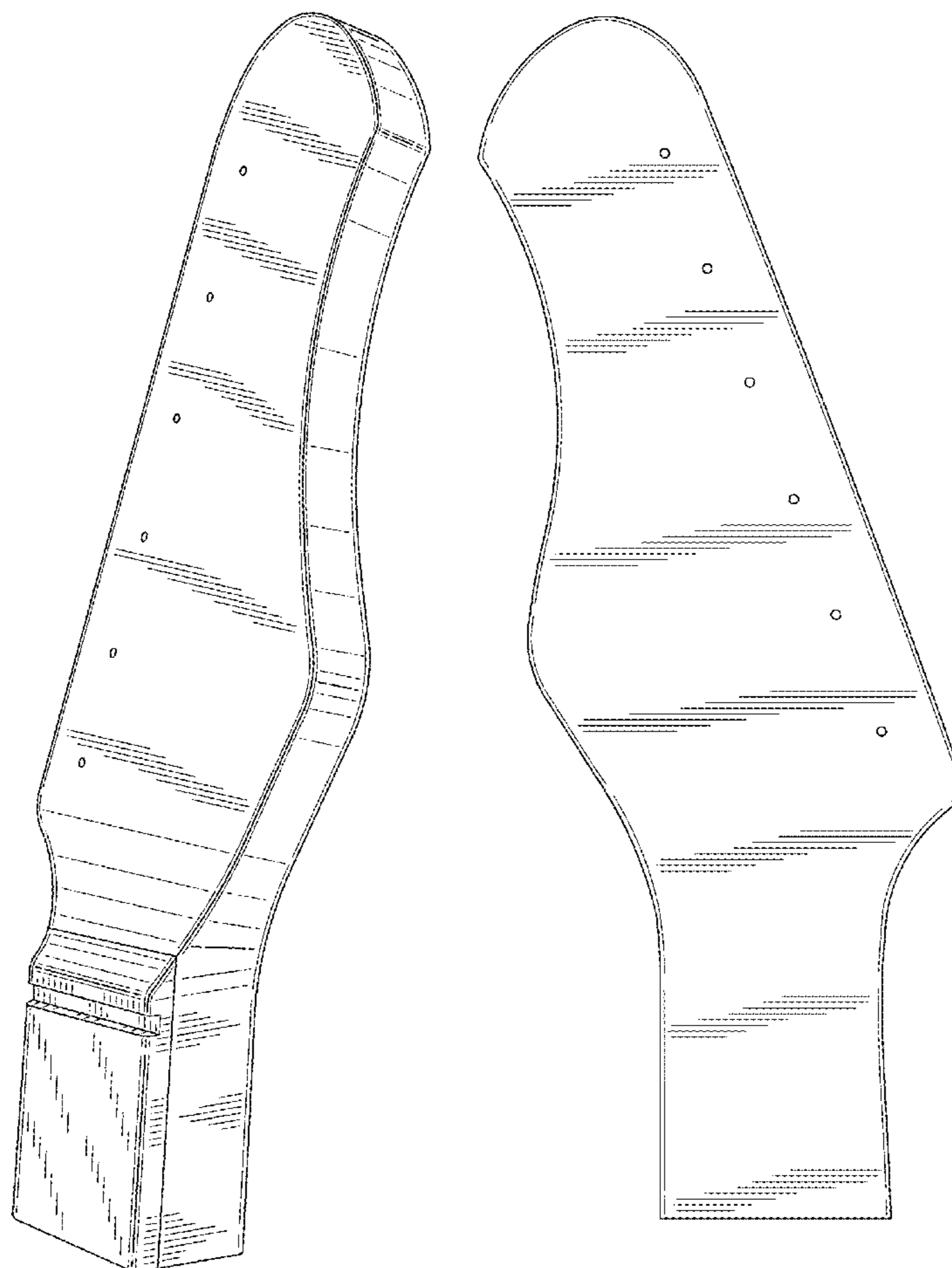

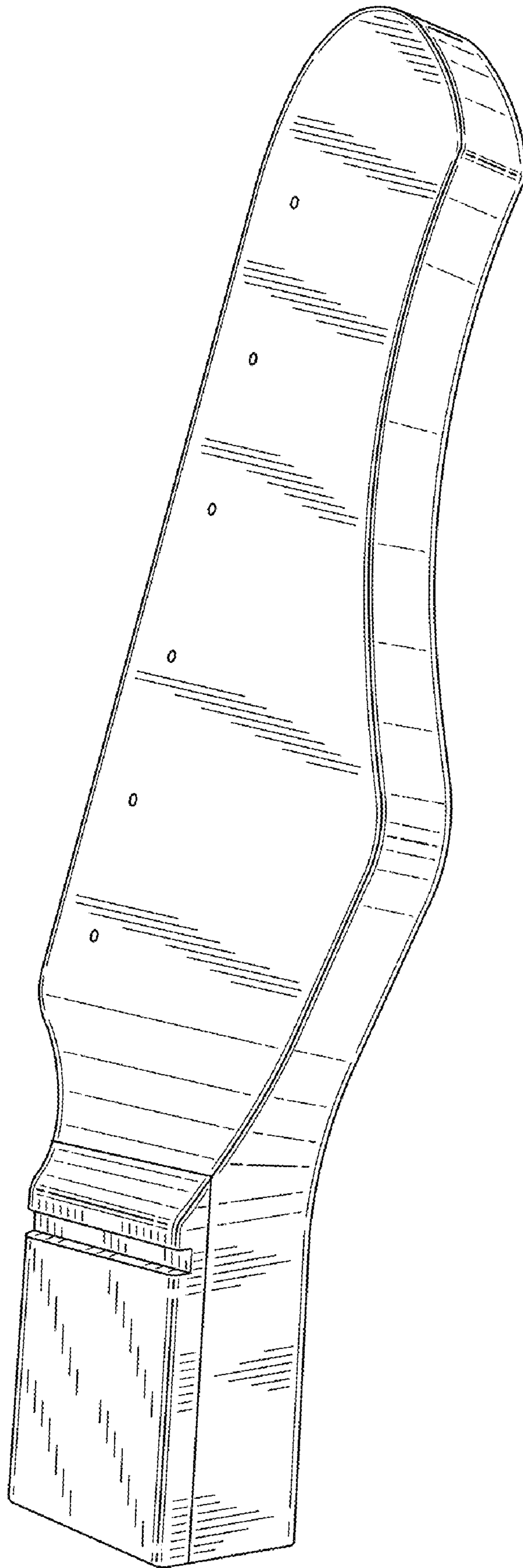

FIG. 1

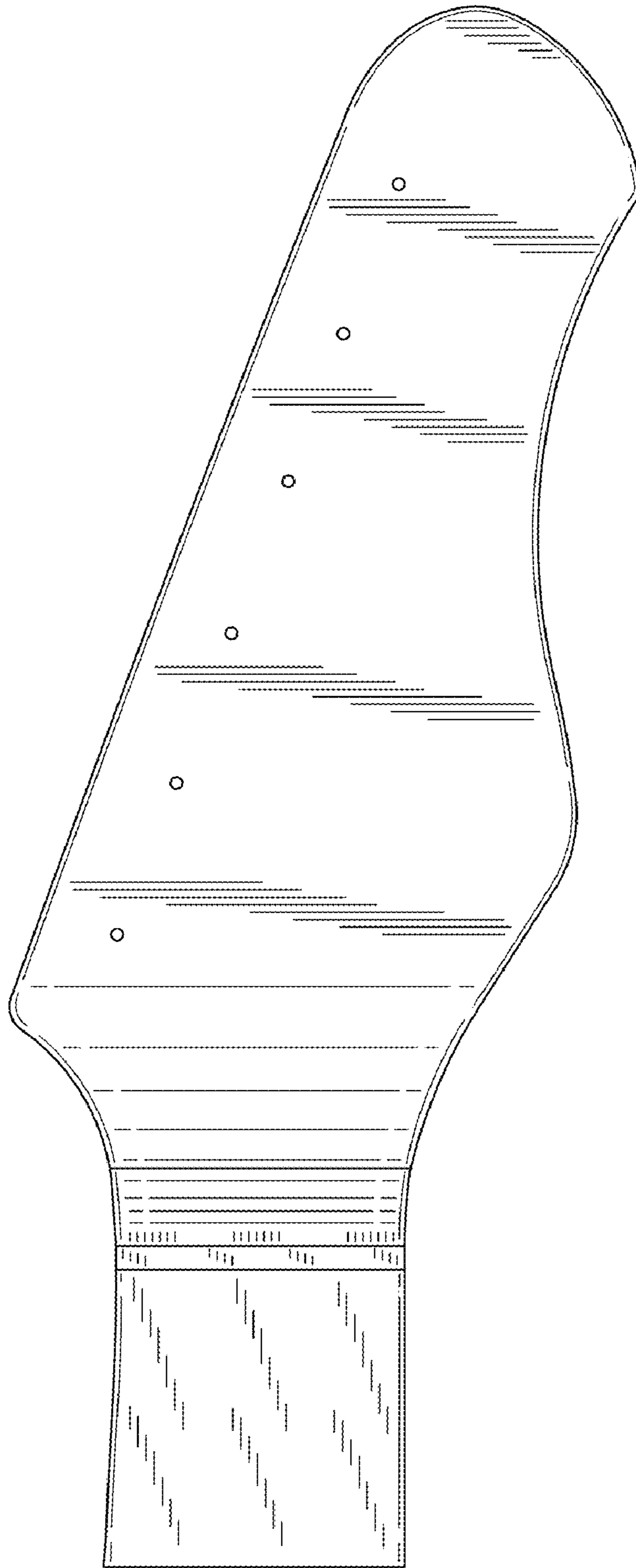

FIG. 2

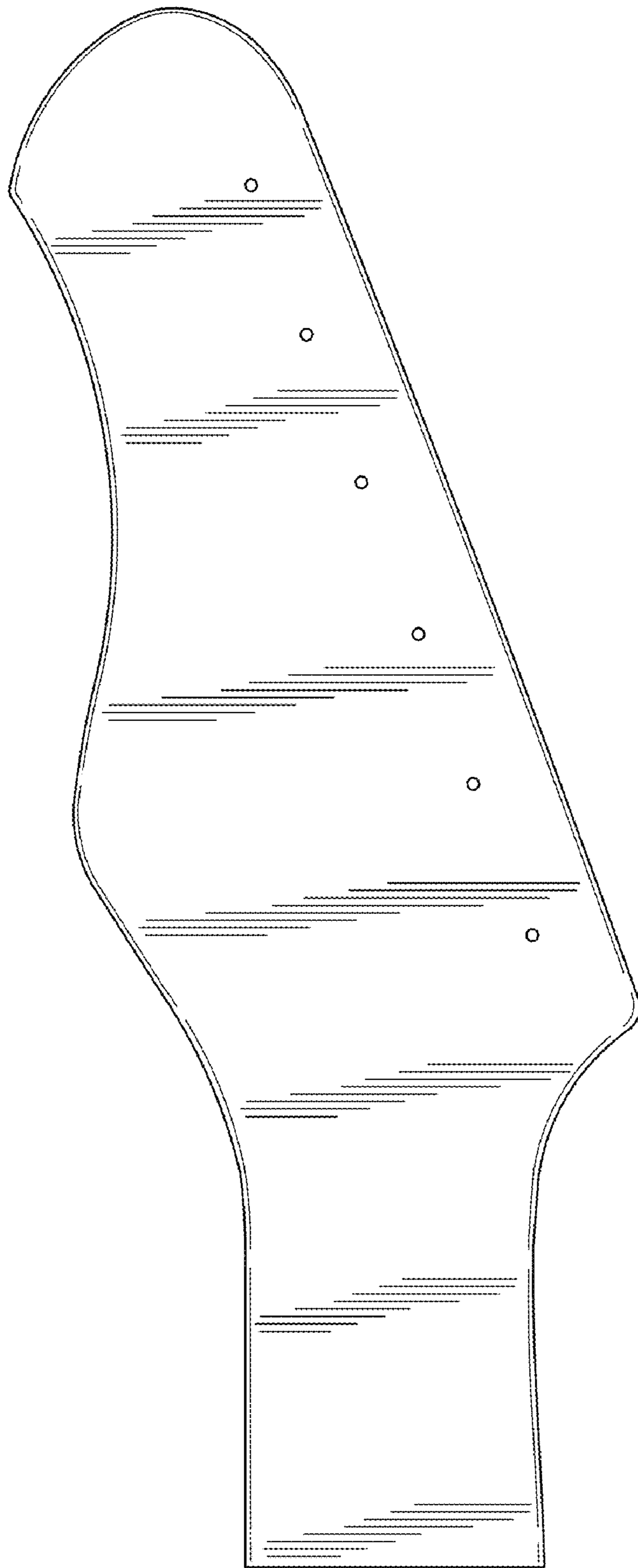

FIG. 3

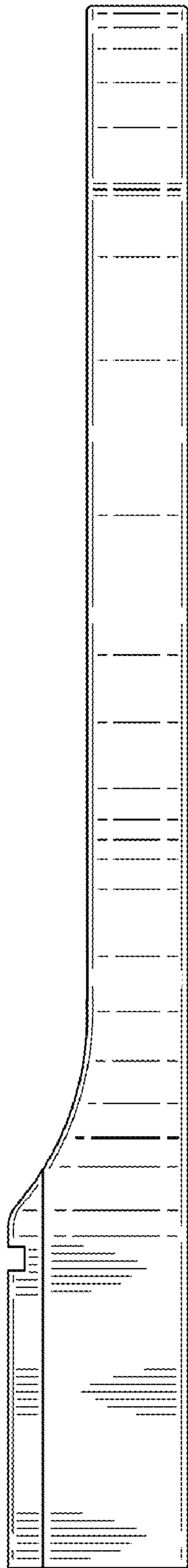

FIG. 4

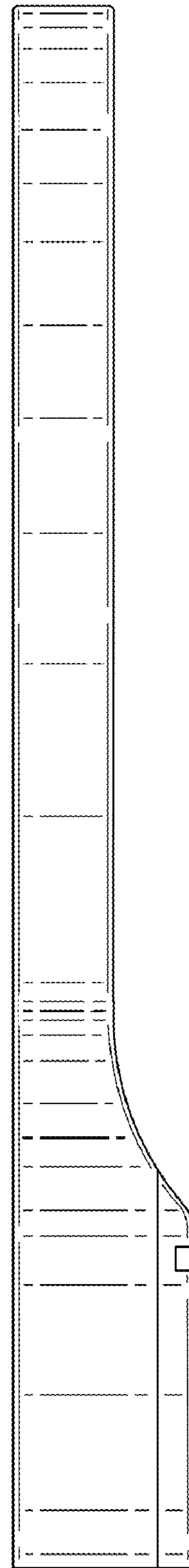

FIG. 5

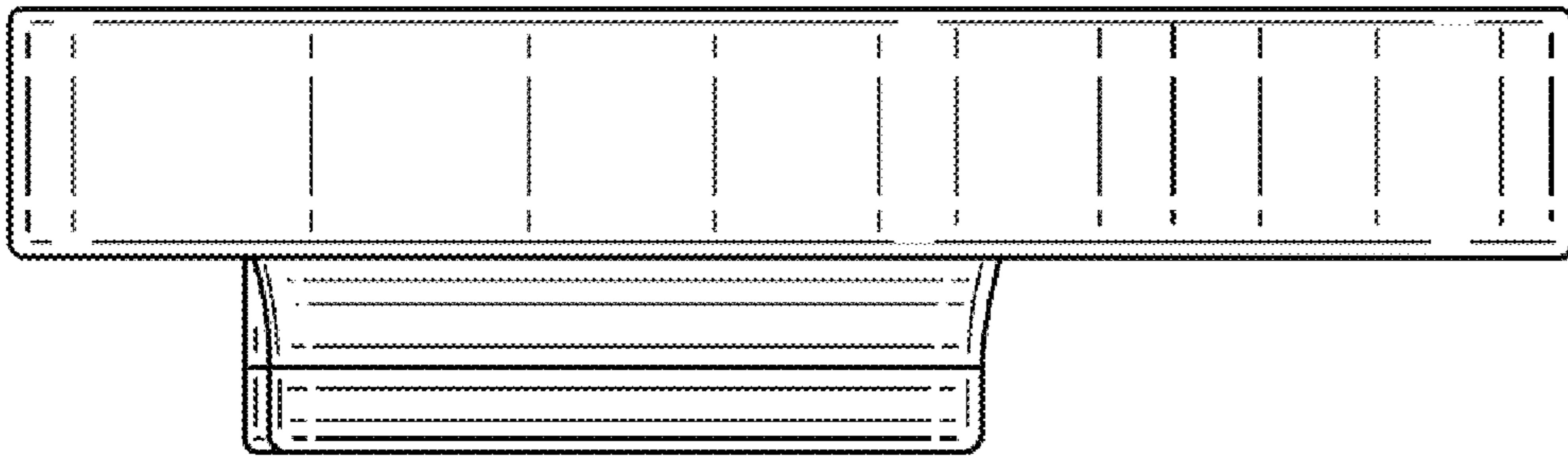

FIG. 6