



US00D677642S

(12) **United States Design Patent**
Park

(10) **Patent No.:** **US D677,642 S**
(45) **Date of Patent:** **** Mar. 12, 2013**

(54) **MOBILE TERMINAL**

(75) Inventor: **Jun-Sang Park**, Anyang-si (KR)

(73) Assignee: **Samsung Electronics Co., Ltd.** (KR)

(**) Term: **14 Years**

(21) Appl. No.: **29/413,285**

(22) Filed: **Feb. 14, 2012**

(30) **Foreign Application Priority Data**

Sep. 5, 2011 (KR) 30-2011-0037150

(51) **LOC (9) Cl.** **14-03**

(52) **U.S. Cl.** **D14/138 G**

(58) **Field of Classification Search** D14/138 G,
D14/138 AD, 341, 346, 138 R, 138 AA, 138 AC,
D14/138 C, 496, 203.1, 203.4, 203.7, 248,
D14/218; 455/575.1, 556.2, 575.3, 575.4;
D21/517; 379/433.01, 433.04; D10/65,
D10/78, 104; D13/168

See application file for complete search history.

(56) **References Cited**

U.S. PATENT DOCUMENTS

D337,569 S *	7/1993	Kando	D14/341
D568,286 S *	5/2008	Suk et al.	D14/138 G
D601,539 S *	10/2009	Hong	D14/138 G
D618,200 S *	6/2010	Kim et al.	D14/138 AD
D621,378 S *	8/2010	Kim et al.	D14/138 AD
D629,782 S *	12/2010	Kim et al.	D14/138 G
D631,029 S *	1/2011	Park et al.	D14/138 G
D635,537 S *	4/2011	Kim	D14/138 G
D635,541 S *	4/2011	Park et al.	D14/138 G
D638,815 S *	5/2011	Lee et al.	D14/138 G
D646,248 S *	10/2011	Lee	D14/138 G
D646,251 S *	10/2011	Park et al.	D14/138 G
D647,501 S *	10/2011	Kim	D14/138 G
D650,766 S *	12/2011	Hong	D14/138 G
D651,186 S *	12/2011	Park et al.	D14/138 G
D654,047 S *	2/2012	Kim et al.	D14/138 G
D654,048 S *	2/2012	Ichinose et al.	D14/138 G
D654,461 S *	2/2012	Kim et al.	D14/138 AD

D654,894 S *	2/2012	Kim	D14/138 G
D657,764 S *	4/2012	Hong	D14/138 G
D658,147 S *	4/2012	Yoon	D14/138 G
D658,148 S *	4/2012	Park	D14/138 AD
D663,278 S *	7/2012	Kim et al.	D14/138 G
D663,709 S *	7/2012	Kim et al.	D14/138 AD
D663,710 S *	7/2012	Park	D14/138 G
D666,570 S *	9/2012	Kim et al.	D14/138 G

OTHER PUBLICATIONS

Samsung Galaxy S II T989 telephone, announced Aug. 2011, [online], [site visited Sep. 26, 2011]. Available from Internet, <URL: http://www.gsmarena.com/samsung_galaxy_s_ii_t989-4129.php>.*

Motorola Droid Bionic XT865 telephone, announced Jan. 2011, [online], [site visited Sep. 26, 2011]. Available from Internet, <URL: http://www.gsmarena.com/motorola_droid_bionic_xt865-4523.php>.*

LG Optimus True HD LTE P936 telephone, announced Apr. 2012, [online], [site visited Sep. 26, 2011]. Available from Internet, <URL: http://www.gsmarena.com/lg_optimus_true_hd_lte_p936-4717.php>.*

(Continued)

Primary Examiner — Jeffrey D Asch
(74) *Attorney, Agent, or Firm* — NSIP Law

(57) **CLAIM**

The ornamental design for a mobile terminal, as shown and described.

DESCRIPTION

FIG. 1 is a perspective view of a mobile terminal;
FIG. 2 is a front view of the mobile terminal of FIG. 1;
FIG. 3 is a rear view of the mobile terminal of FIG. 1;
FIG. 4 is a left-side view of the mobile terminal of FIG. 1;
FIG. 5 is a right-side view of the mobile terminal of FIG. 1;
FIG. 6 is a top plan view of the mobile terminal of FIG. 1; and,
FIG. 7 is a bottom plan view of mobile terminal of FIG. 1.
The images shown in broken lines in the bottom portion of the mobile terminal of FIGS. 1 and 2 are for illustrative purposes only and form no part of the claimed design.

1 Claim, 5 Drawing Sheets

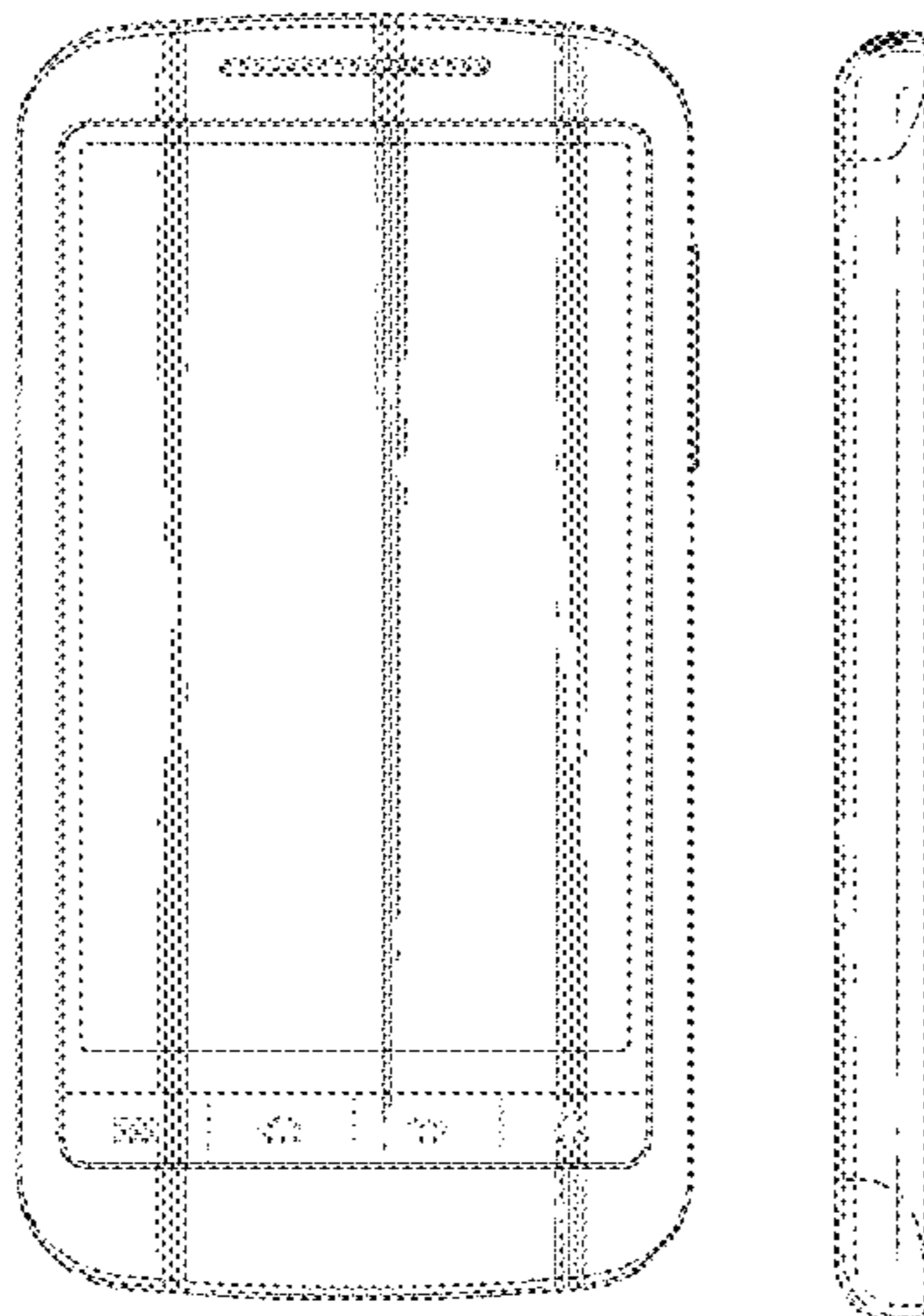

OTHER PUBLICATIONS

Motorola Atrix 2 telephone, announced Oct. 2011, [online], [site visited Sep. 26, 2011]. Available from Internet, <URL: http://www.gsmarena.com/motorola_triumph-3988.php>.*

HTC One ST telephone, announced Aug. 2012, [online], [site visited Sep. 26, 2011]. Available from Internet, <URL: http://www.gsmarena.com/htc_one_st-4980.php>.*

Alcatel OT-993 telephone, announced Aug. 2012, [online], [site visited Sep. 26, 2011]. Available from Internet, <URL: http://www.gsmarena.com/alcatel_ot_993-4846.php>.*

Motorola Defy XT telephone, announced Jul. 2012, [online], [site visited Sep. 26, 2011]. Available from Internet, <URL: http://www.gsmarena.com/motorola_defy_xt-4892.php>.*

Samsung Conquer 4G telephone, announced Jun. 2011, [online], [site visited Sep. 26, 2011]. Available from Internet, <URL: http://www.gsmarena.com/samsung_conquer_4g-4026.php>.*

Samsung C3300K Champ telephone, announced May 2010, [online], [site visited Sep. 26, 2011]. Available from Internet, <URL: http://www.gsmarena.com/samsung_c3300k_champ-3346.php>.*

Samsung Galaxy Victory 4G LTE L300 telephone, announced Sep. 2012, [online], [site visited Sep. 26, 2011]. Available from Internet, <URL: http://www.gsmarena.com/samsung_galaxy_victory_4g_lte_l300-4992.php>.*

LG KS660 telephone, announced Feb. 2009, [online], [site visited Sep. 26, 2011]. Available from Internet, <URL: http://www.gsmarena.com/lg_ks660-2790.php>.*

Samsung Galaxy Nexus i515 telephone, announced Oct. 2011, [online], [site visited Sep. 26, 2011]. Available from Internet, <URL: http://www.gsmarena.com/samsung_galaxy_nexus_i515-4301.php>.*

* cited by examiner

FIG. 1

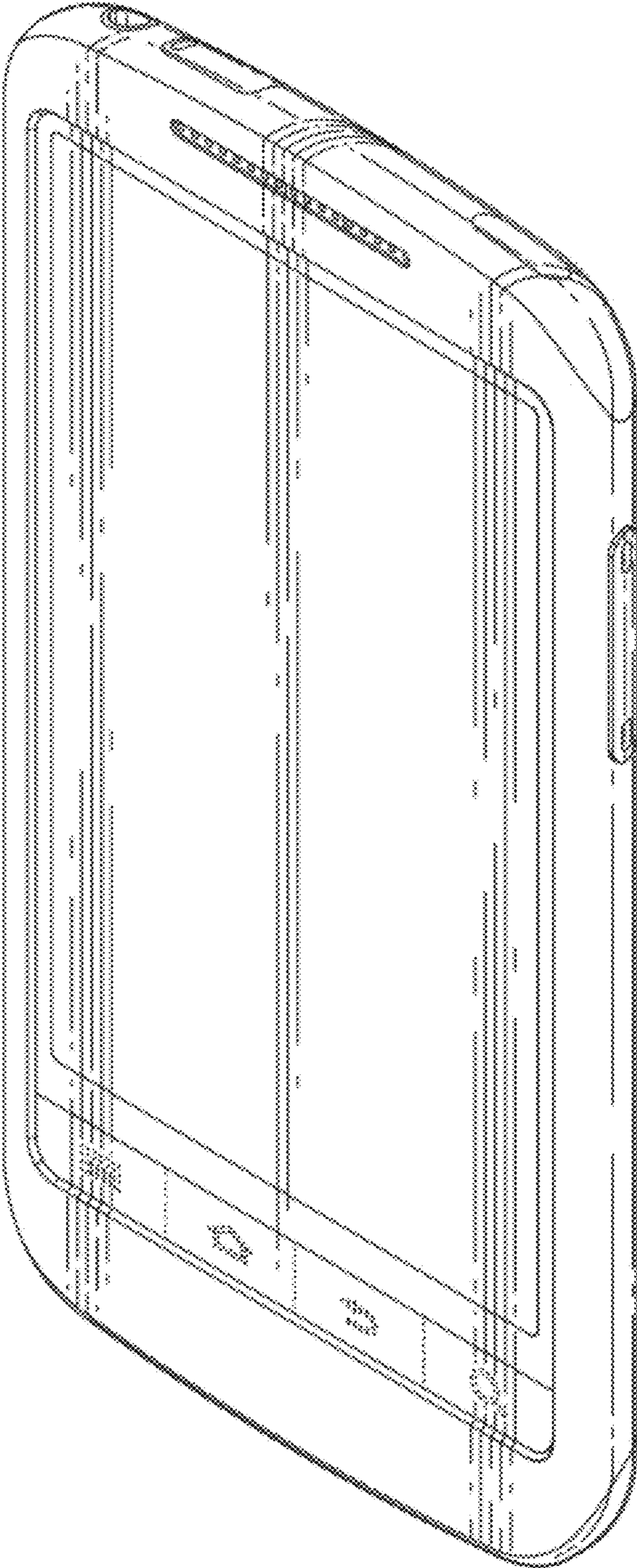

FIG. 2

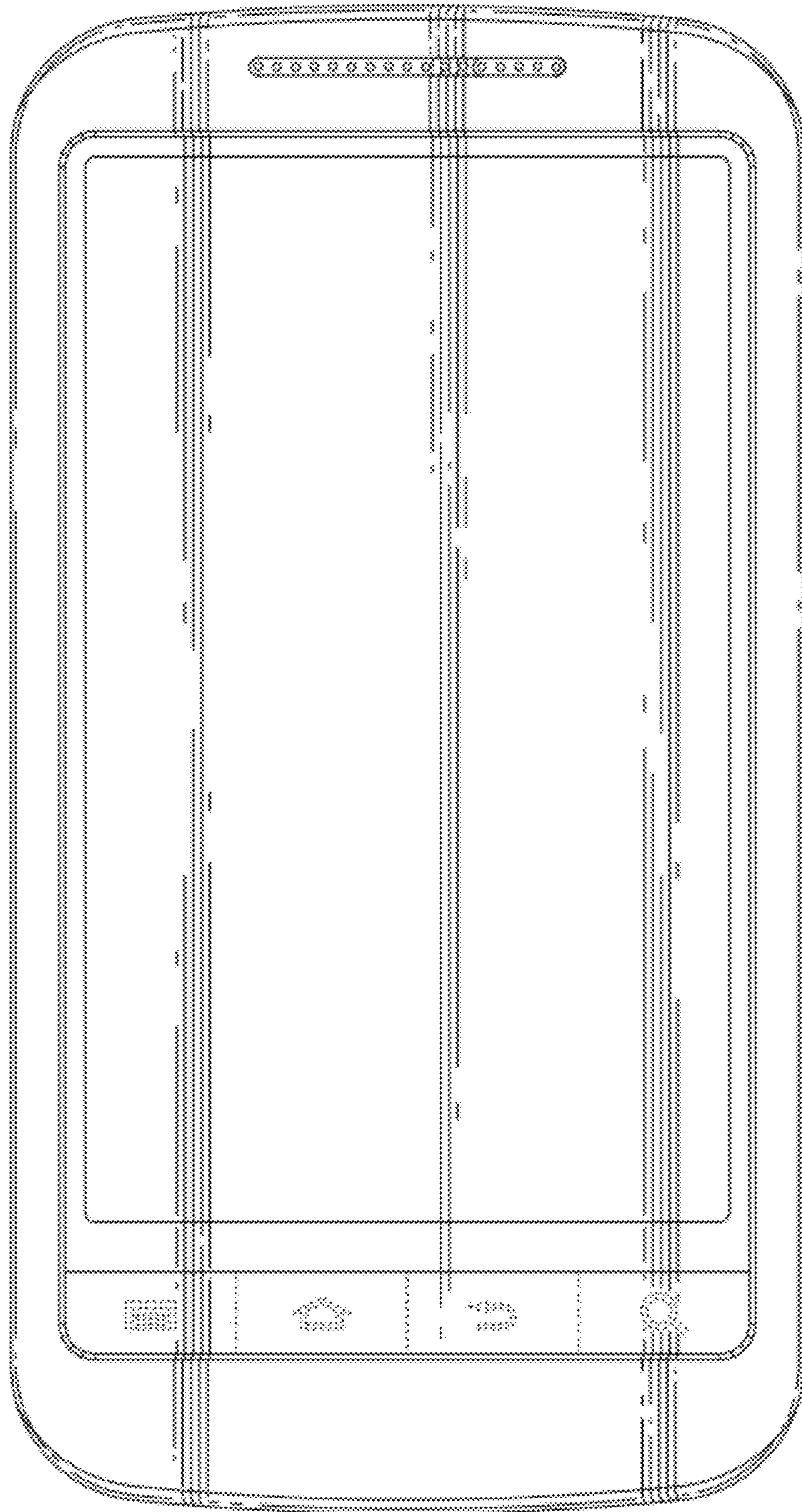

FIG. 3

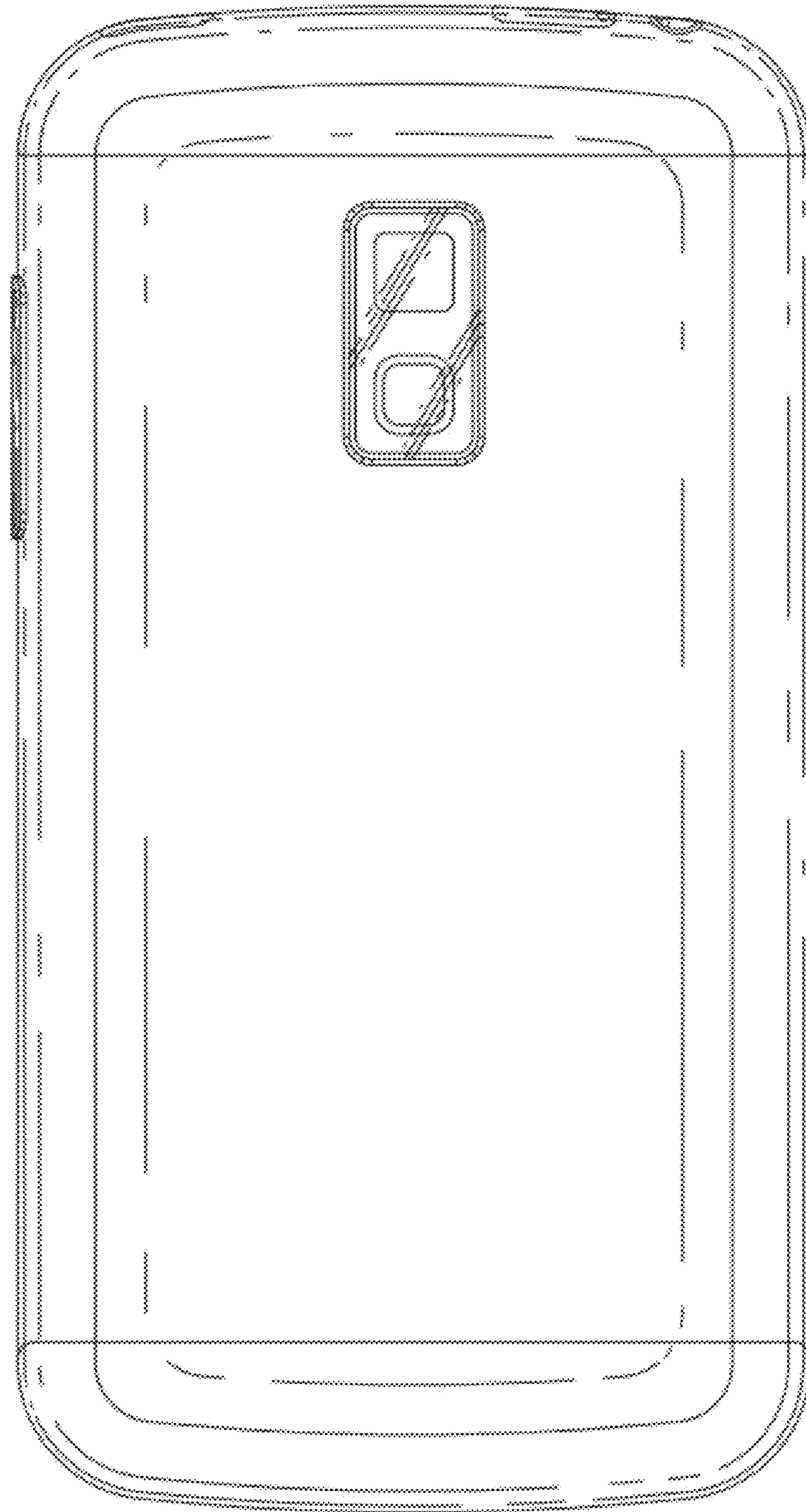

FIG. 4

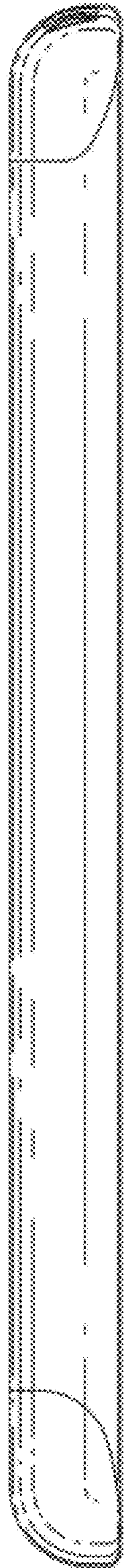

FIG. 5

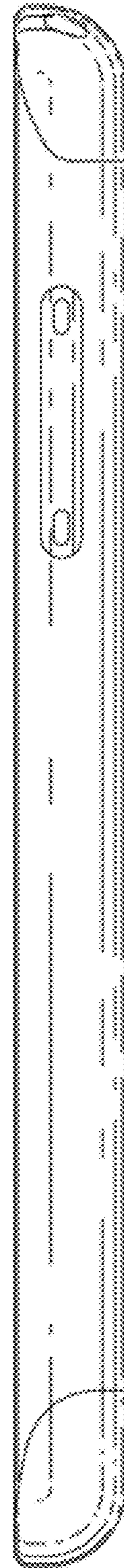

FIG. 6

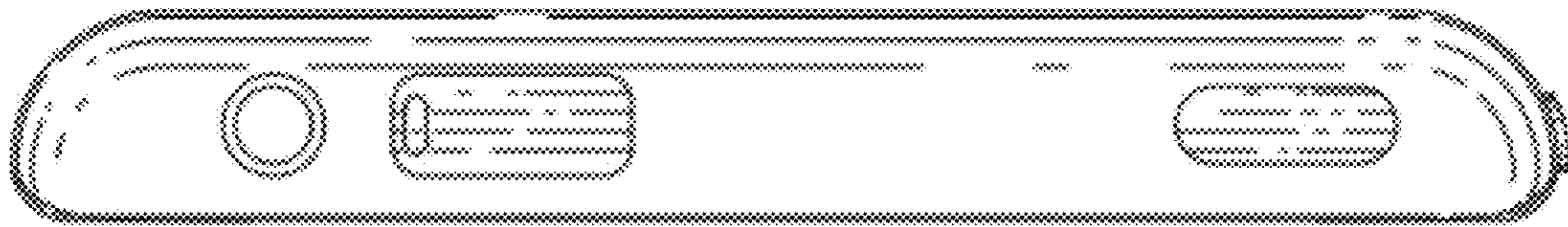

FIG. 7

