

US00D677565S

(12) **United States Design Patent**
Barbieri et al.

(10) **Patent No.:** **US D677,565 S**
(45) **Date of Patent:** **** Mar. 12, 2013**

(54) **PACKAGE AND MATERIAL FOR PACKAGING**

(75) Inventors: **Marcello Barbieri**, Modena (IT);
Siegrid Putzer, Modena (IT); **Alice Olivieri**, Modena (IT); **Stefania Pertusi**, Sant' Agata Bolognese (IT); **Joyce Nassif**, Modena (IT)

(73) Assignee: **Tetra Laval Holdings & Finance S.A.**, Pully (CH)

(**) Term: **14 Years**

(21) Appl. No.: **29/430,159**

(22) Filed: **Aug. 22, 2012**

Related U.S. Application Data

(62) Division of application No. 29/380,548, filed on Dec. 7, 2010, now Pat. No. Des. 668,539.

(30) **Foreign Application Priority Data**

Jun. 7, 2010 (EM) 1218549-0001
Jun. 7, 2010 (EM) 1218549-0002
Jun. 7, 2010 (EM) 1218549-0003

(51) **LOC (9) Cl.** **09-03**

(52) **U.S. Cl.** **D9/431; D9/433**

(58) **Field of Classification Search** D9/414,
D9/418, 420-424, 430-433; 206/267, 269,
206/270, 273, 299, 737, 740, 822; 229/100,
229/101, 101.3, 106, 108-112, 114-117,
229/117.05-117.09, 117.24, 117.26, 221,
229/222, 227, 902, 939, 941, 942; D3/272

See application file for complete search history.

(56) **References Cited**

U.S. PATENT DOCUMENTS

4,343,402	A *	8/1982	Holmstrom	229/216
D310,822	S *	9/1990	Danek	D13/162.1
D318,460	S *	7/1991	Heath et al.	D13/160
D401,148	S	11/1998	Bouraoui et al.		
D447,941	S	9/2001	Quensel et al.		
D464,566	S	10/2002	Anchor et al.		
D502,103	S	2/2005	Schmedes		
D511,502	S *	11/2005	Kim	D13/160
7,017,796	B2	3/2006	Ishikawa		
D534,073	S	12/2006	Stillerud		
D536,964	S	2/2007	Smith et al.		
D543,851	S	6/2007	Franic		
D605,506	S *	12/2009	Franic	D9/433
D609,088	S	2/2010	Kvam		
D624,404	S *	9/2010	Darbonne	D9/431
D635,018	S	3/2011	Wallace et al.		
7,934,637	B2	5/2011	Kaneko		
D668,539	S *	10/2012	Barbieri et al.	D9/431
2007/0170233	A1	7/2007	Fontanazzi		
2011/0192118	A1	8/2011	Kaneko		

* cited by examiner

Primary Examiner — Thomas Johannes

(74) *Attorney, Agent, or Firm* — Finnegan, Henderson, Farabow, Garrett & Dunner, LLP

(57) **CLAIM**

We claim the ornamental design for package and material for packaging, as shown and described.

DESCRIPTION

FIG. 1 is a top plan view of material for packaging according to our new design;
FIG. 2 is a right side view of a package, which is assembled, in part, from the material for packaging of FIG. 1;
FIG. 3 is a left side view thereof;
FIG. 4 is a front view thereof;
FIG. 5 is a rear view thereof;
FIG. 6 is a top view thereof; and,
FIG. 7 is a perspective view thereof.

1 Claim, 2 Drawing Sheets

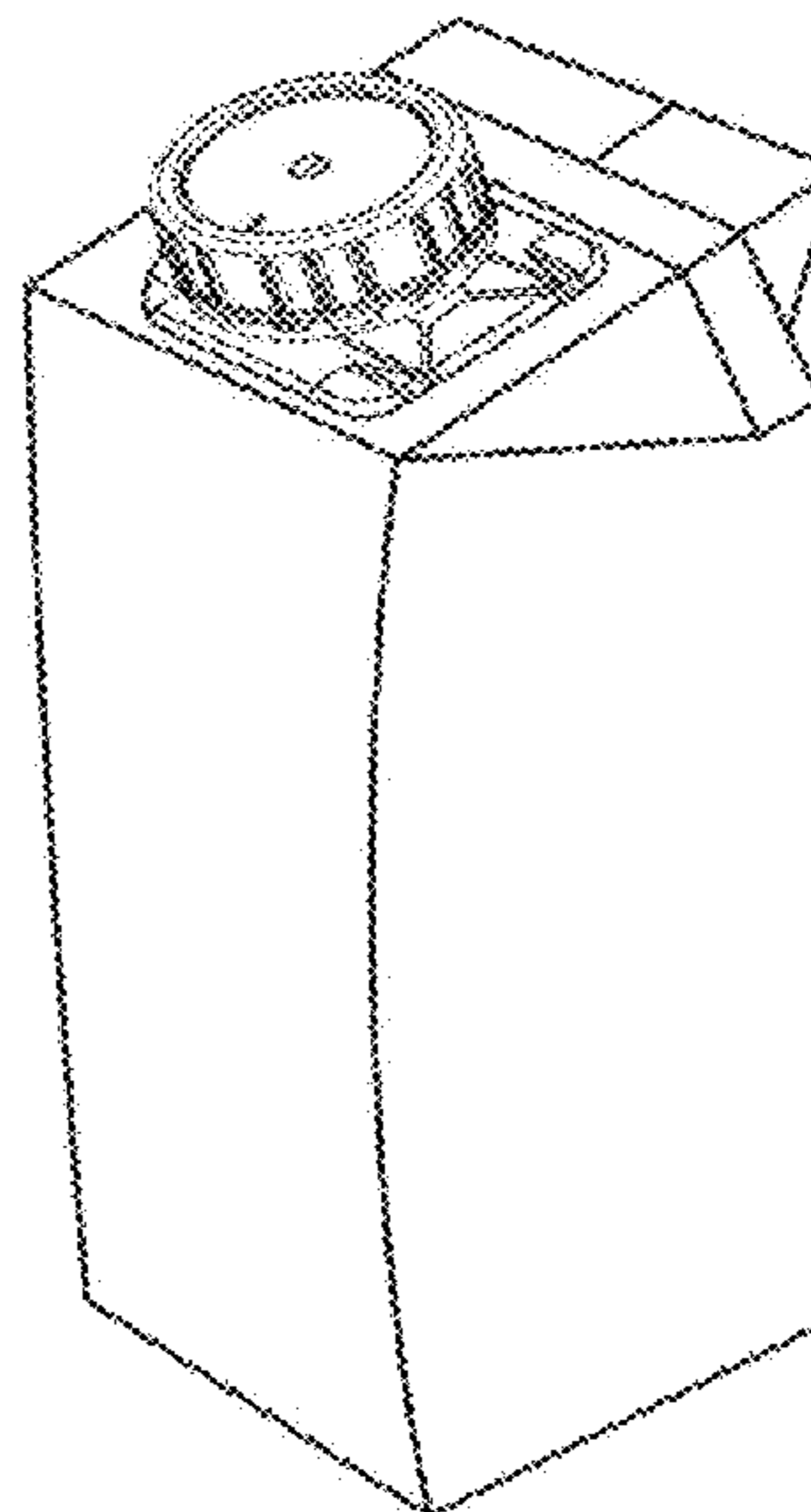
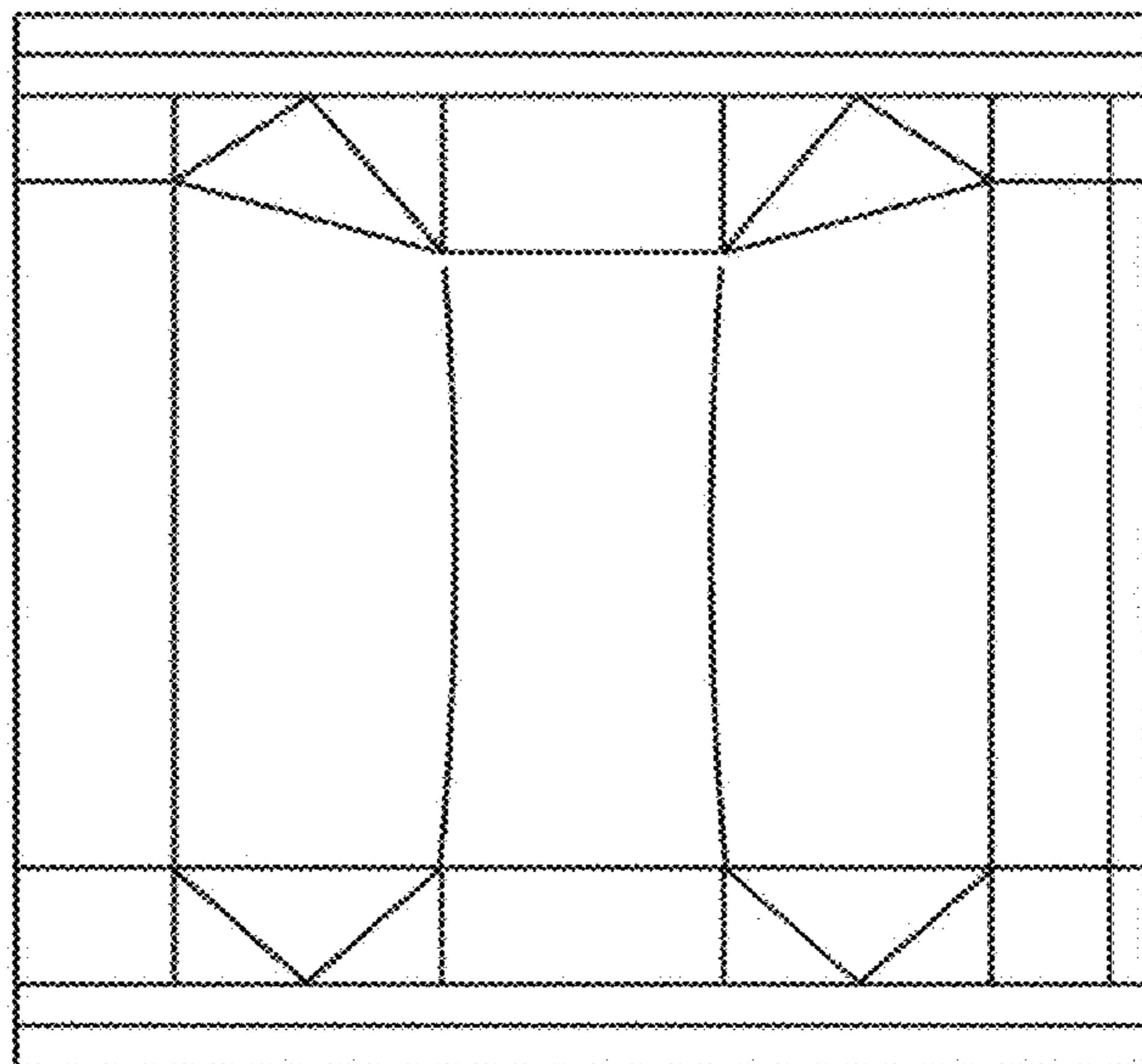

FIG. 1

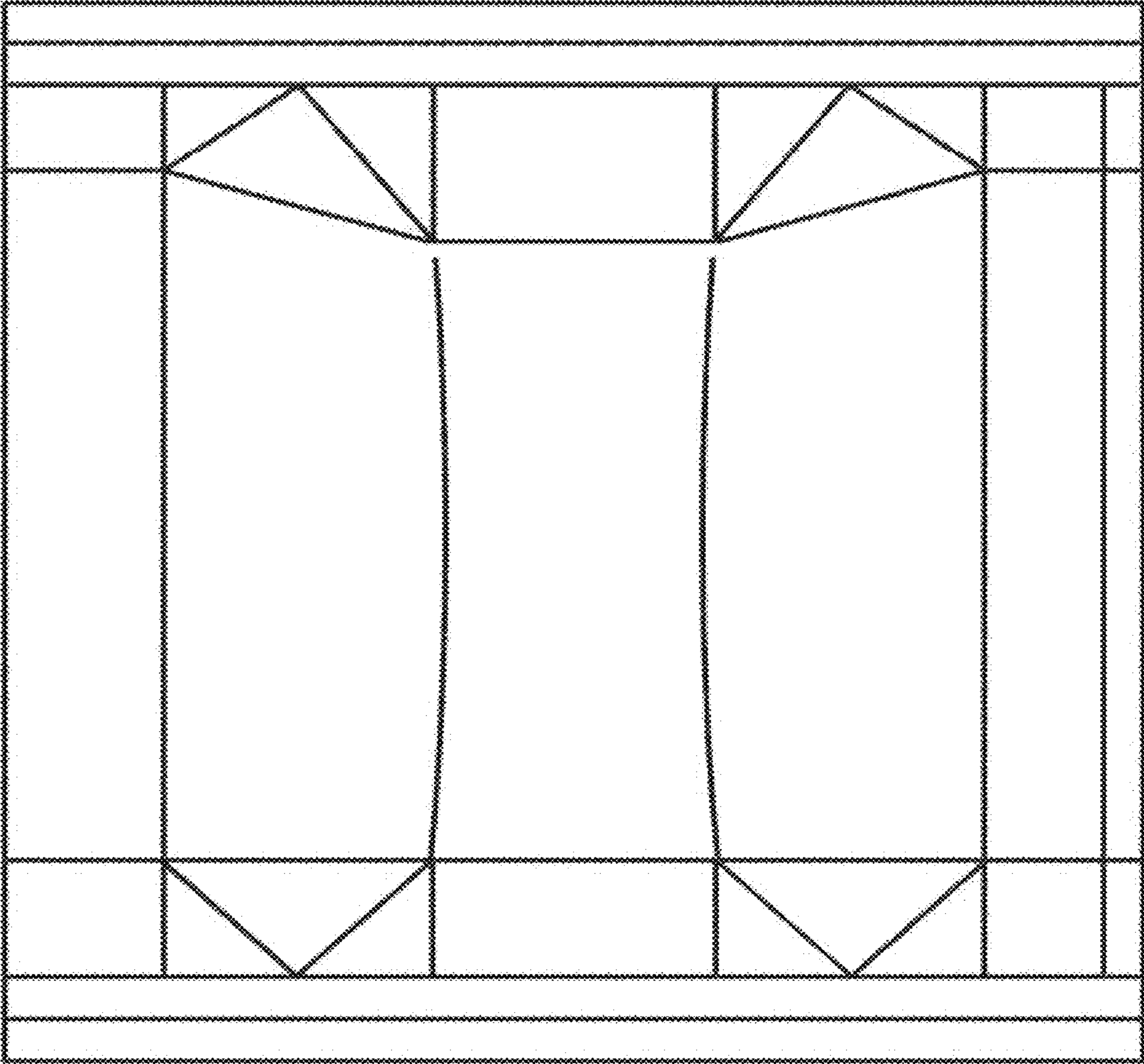

FIG. 2

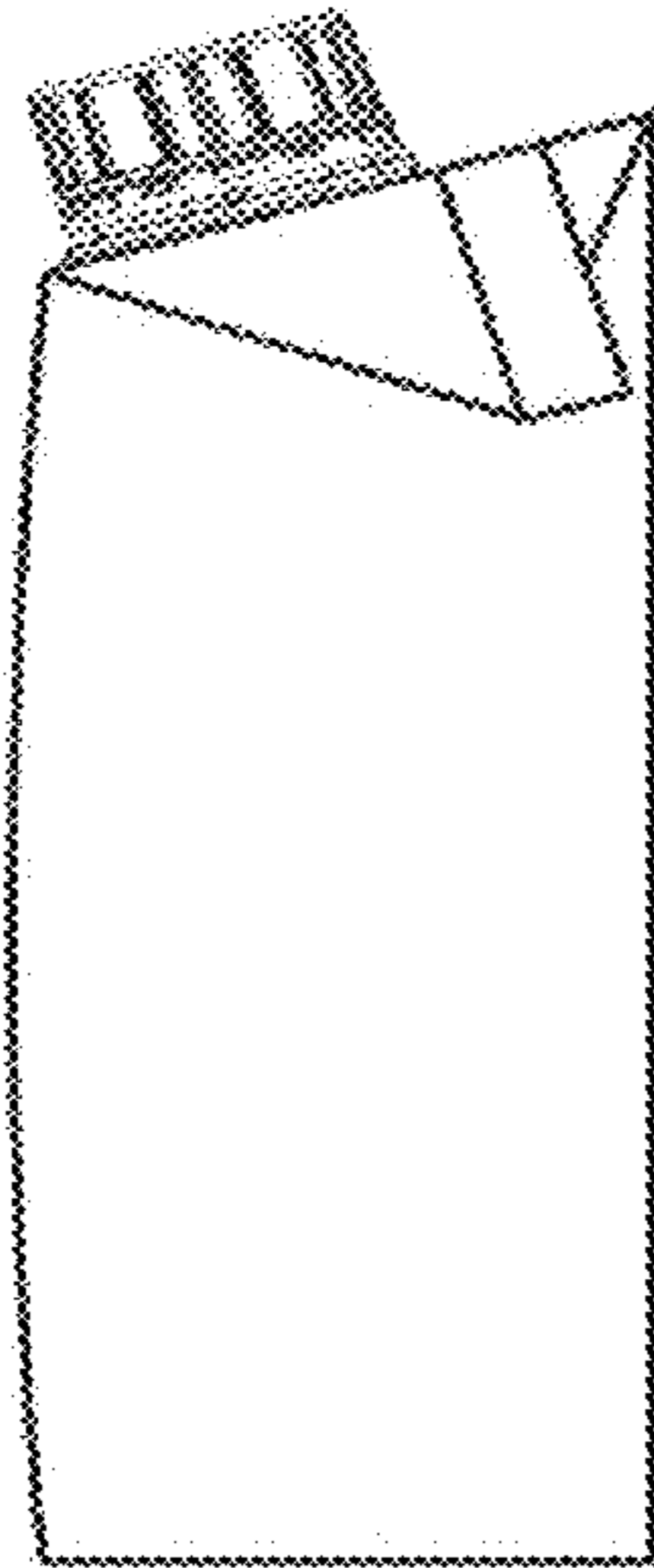

FIG. 4

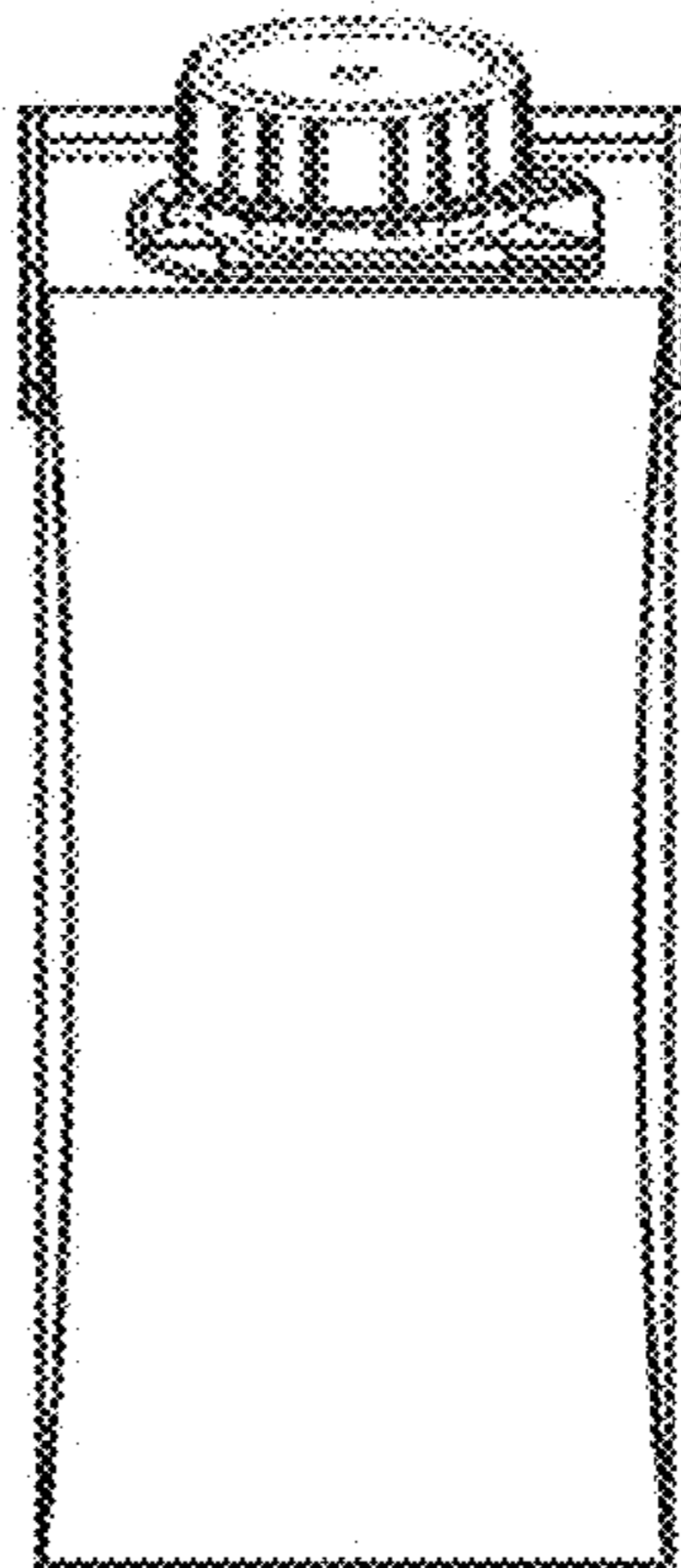

FIG. 7

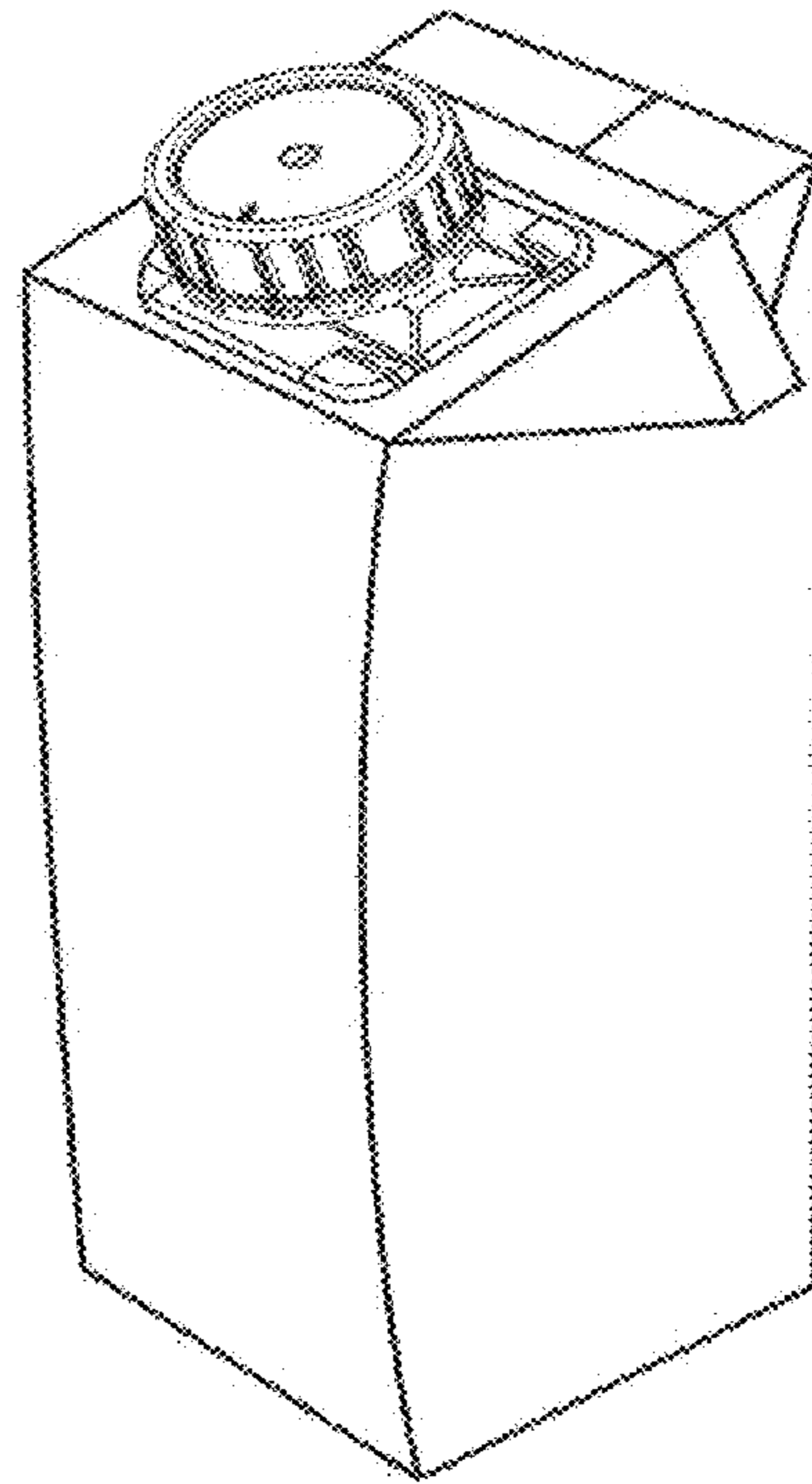

FIG. 3

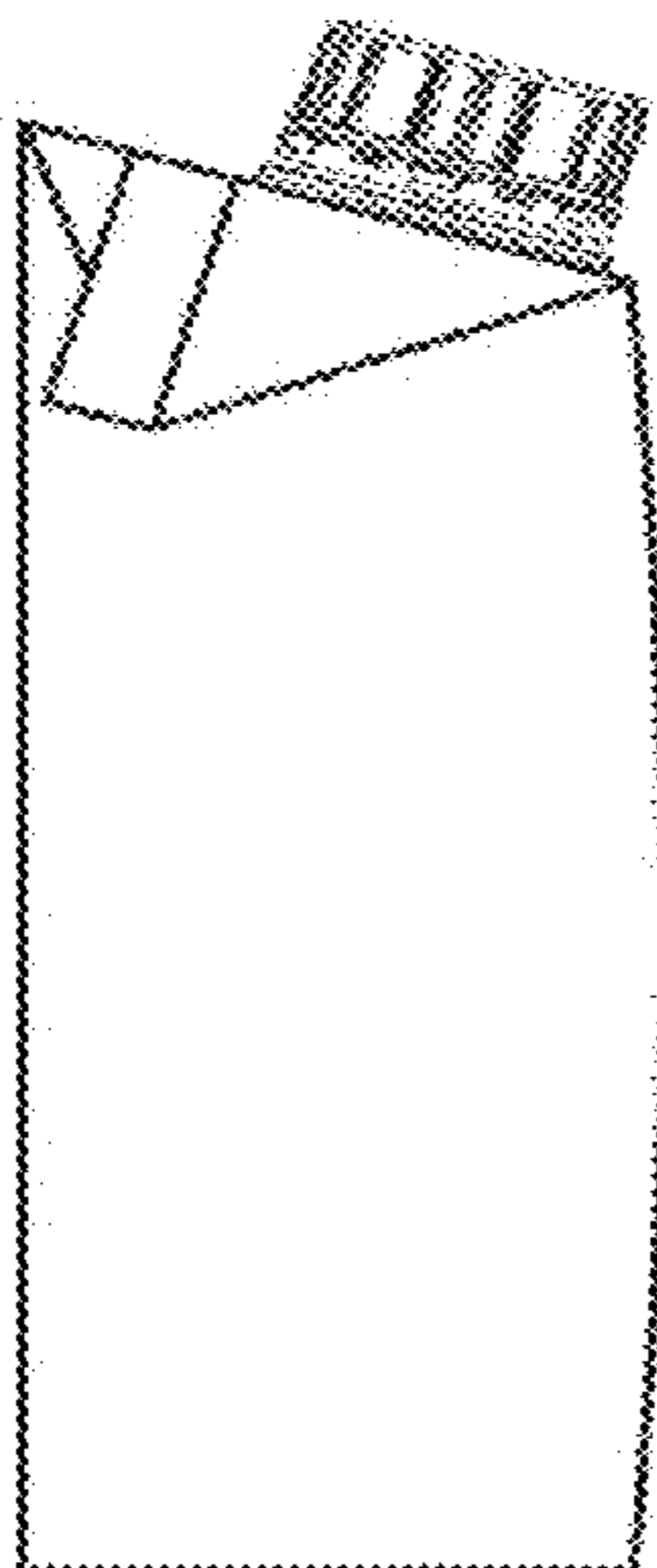

FIG. 5

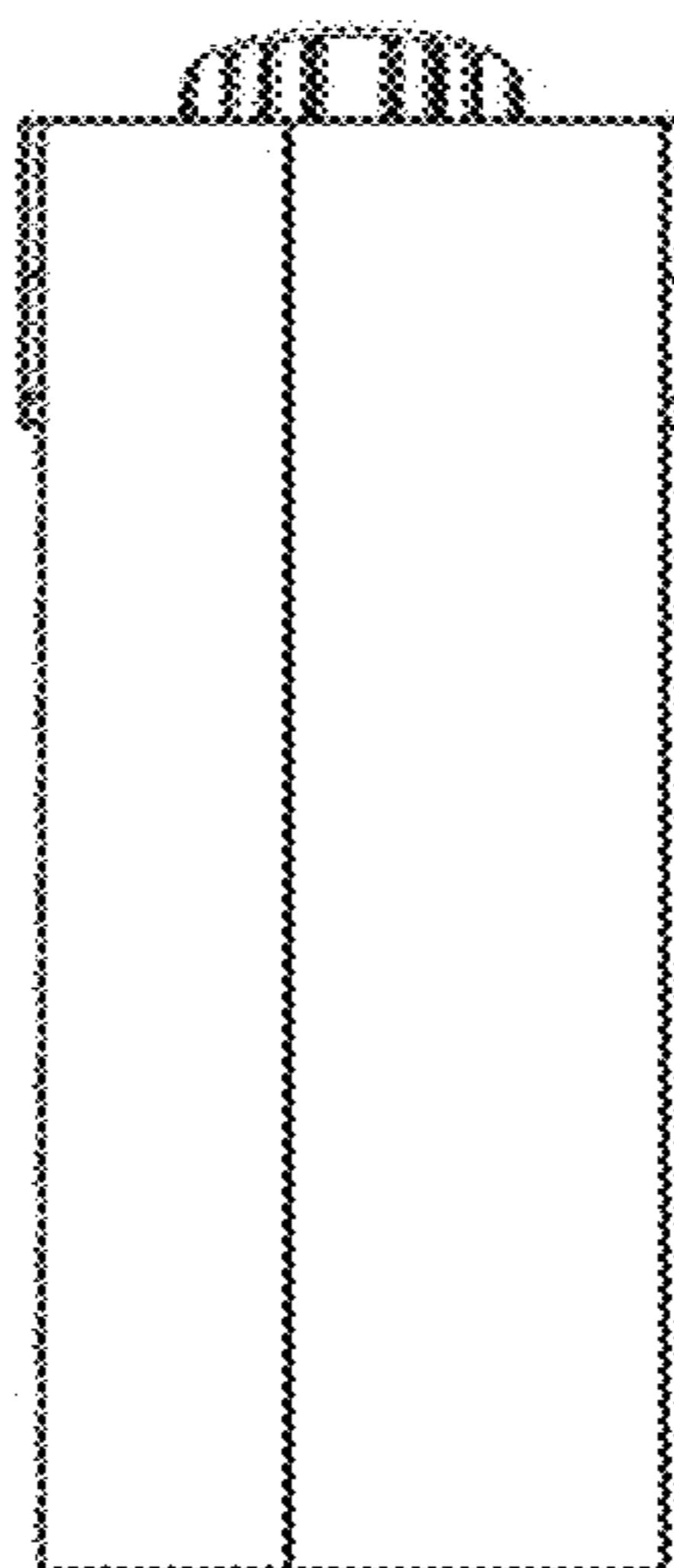

FIG. 6

