



US00D677513S

(12) **United States Design Patent**
Blacken

(10) **Patent No.:** **US D677,513 S**

(45) **Date of Patent:** **** *Mar. 12, 2013**

(54) **WAFFLE MAKER**

(75) Inventor: **Lars Blacken**, Roswell, GA (US)

(73) Assignee: **Calphalon Corporation**, Atlanta, GA (US)

(*) Notice: This patent is subject to a terminal disclaimer.

(**) Term: **14 Years**

(21) Appl. No.: **29/394,413**

(22) Filed: **Jun. 16, 2011**

(51) **LOC (9) Cl.** **07-02**

(52) **U.S. Cl.** **D7/352; D7/362; D7/363**

(58) **Field of Classification Search** D7/323,
D7/329-331, 337, 339, 346-347, 350.1-350.4,
D7/352-367, 391, 393, 395, 402, 409, 538,
D7/542; 99/324-325, 331-332, 337-340,
99/369, 375, 400-418, 422, 425, 444-446,
99/483; 126/37 R, 261, 378.1; 206/501-505,
206/507-508; 219/386, 400, 405, 429-442,
219/450.1, 620-624, 725, 730-735; 220/315,
220/573.1-573.5, 912; 426/438, 441
See application file for complete search history.

(56) **References Cited**

U.S. PATENT DOCUMENTS

4,307,658	A	12/1981	Kaebitzsch	
4,476,379	A	10/1984	Andrizzi	
D309,844	S *	8/1990	Storsberg	D7/352
D334,108	S *	3/1993	Fisher	D7/323
D364,992	S *	12/1995	Wooderson et al.	D7/352
5,636,564	A	6/1997	Weiss	
D411,937	S *	7/1999	Siegler et al.	D7/352
D419,823	S *	2/2000	Choi	D7/352
6,427,581	B1	8/2002	Wu	
D467,766	S *	12/2002	Wanat et al.	D7/352
6,555,795	B2	4/2003	Glucksman	
6,889,602	B2	5/2005	Brady	
D523,284	S *	6/2006	Lam	D7/352
D543,410	S *	5/2007	Cohen et al.	D7/352

D575,576	S *	8/2008	Chao	D7/352
D586,174	S *	2/2009	Averty	D7/352
D602,732	S *	10/2009	Busse et al.	D7/352
7,752,958	B2 *	7/2010	Cohen et al.	99/375
D626,783	S *	11/2010	Kaow et al.	D7/352
2006/0201333	A1	9/2006	Friel	

OTHER PUBLICATIONS

Cuisinart, Round Classic Waffle Maker WMR-CA Manual, <http://www.cuisinart.com/share/pdf/manuals/wmr-ca.pdf>, 3 pages, Jun. 15, 2011.

Villaware, Classic Waffler Round UNO Series No. 2004 Manual, www.villaware.com/manuals/VillaWare/V5800_English.pdf, 2 pages, Jun. 15, 2011.

* cited by examiner

Primary Examiner — Ricky Pham

(74) *Attorney, Agent, or Firm* — Newell Rubbermaid, Inc.

(57) **CLAIM**

The ornamental design for a “waffle maker,” as shown and described.

DESCRIPTION

FIG. 1 is a perspective view of a waffle maker, showing my new design, according to one embodiment;

FIG. 2 is a back elevational view of the waffle maker shown in FIG. 1;

FIG. 3 is a front elevational view of the waffle maker shown in FIG. 1;

FIG. 4 is a right side elevational view of the waffle maker shown in FIG. 1;

FIG. 5 is a left side elevational view of the waffle maker shown in FIG. 1;

FIG. 6 is a top plan view of the waffle maker shown in FIG. 1; and,

FIG. 7 is a bottom plan view of the waffle maker shown in FIG. 1.

The subject matter shown in dashed lines is for illustrative purposes and forms no part of the claimed design.

1 Claim, 5 Drawing Sheets

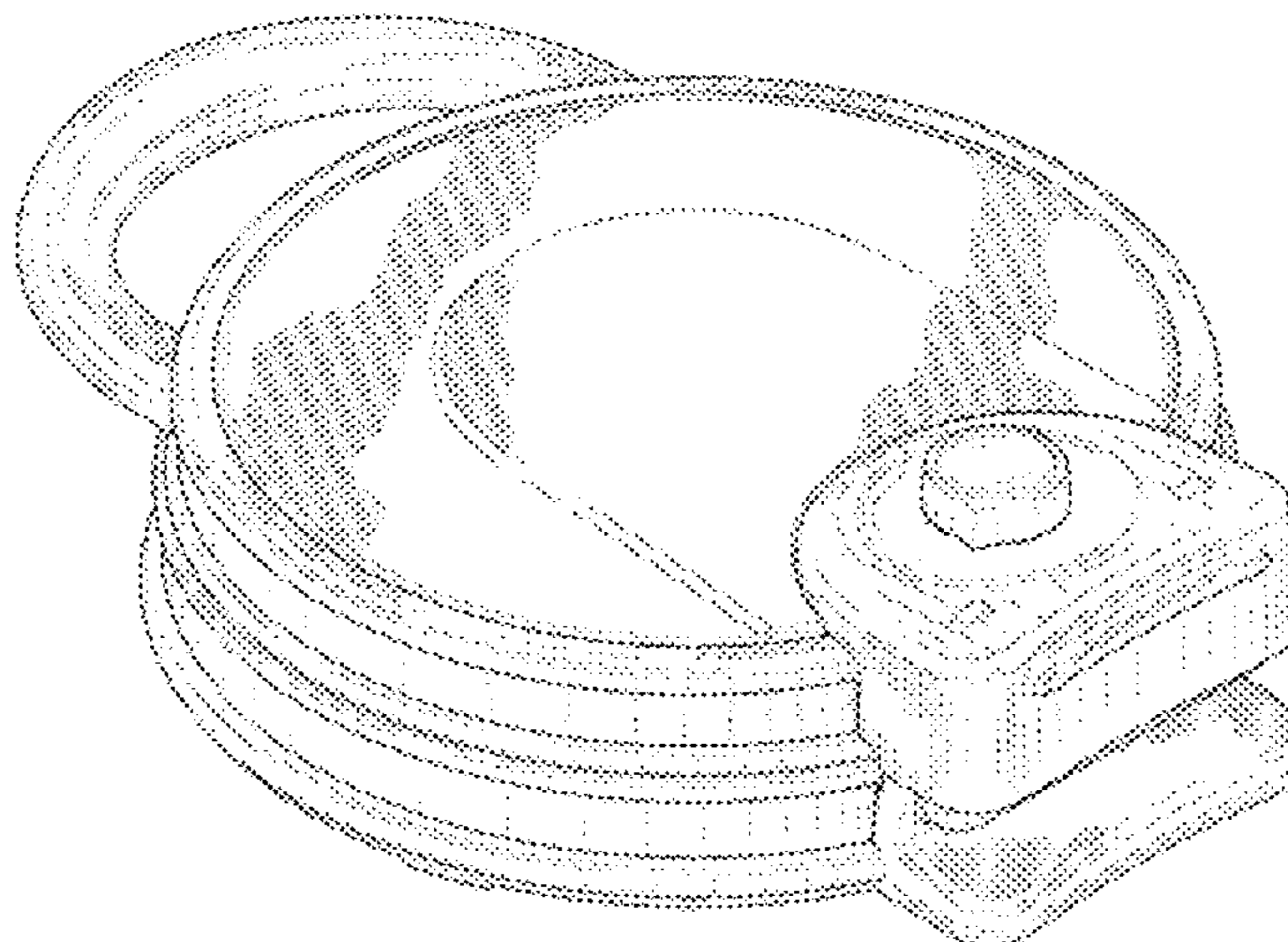

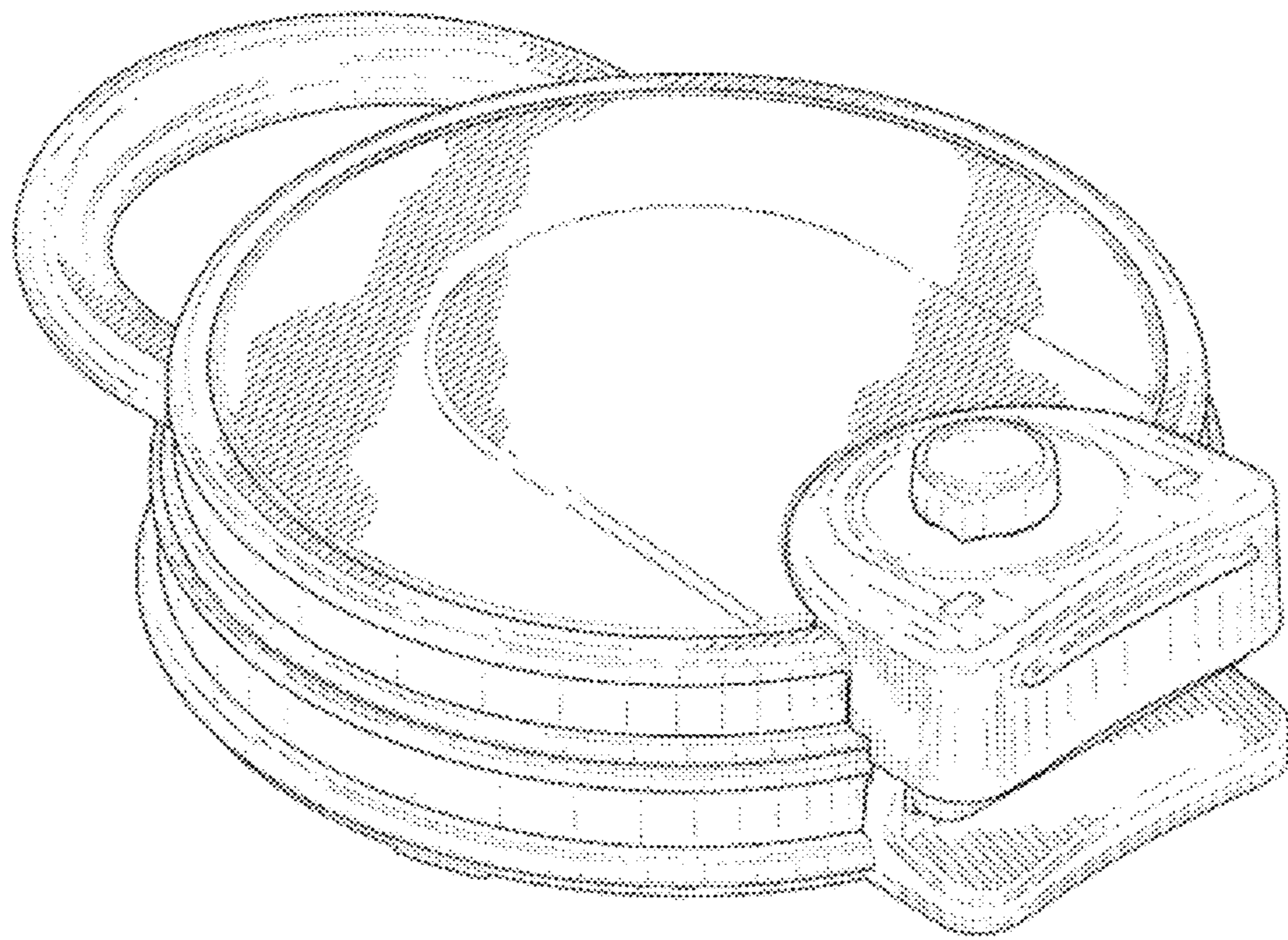

FIG. 1

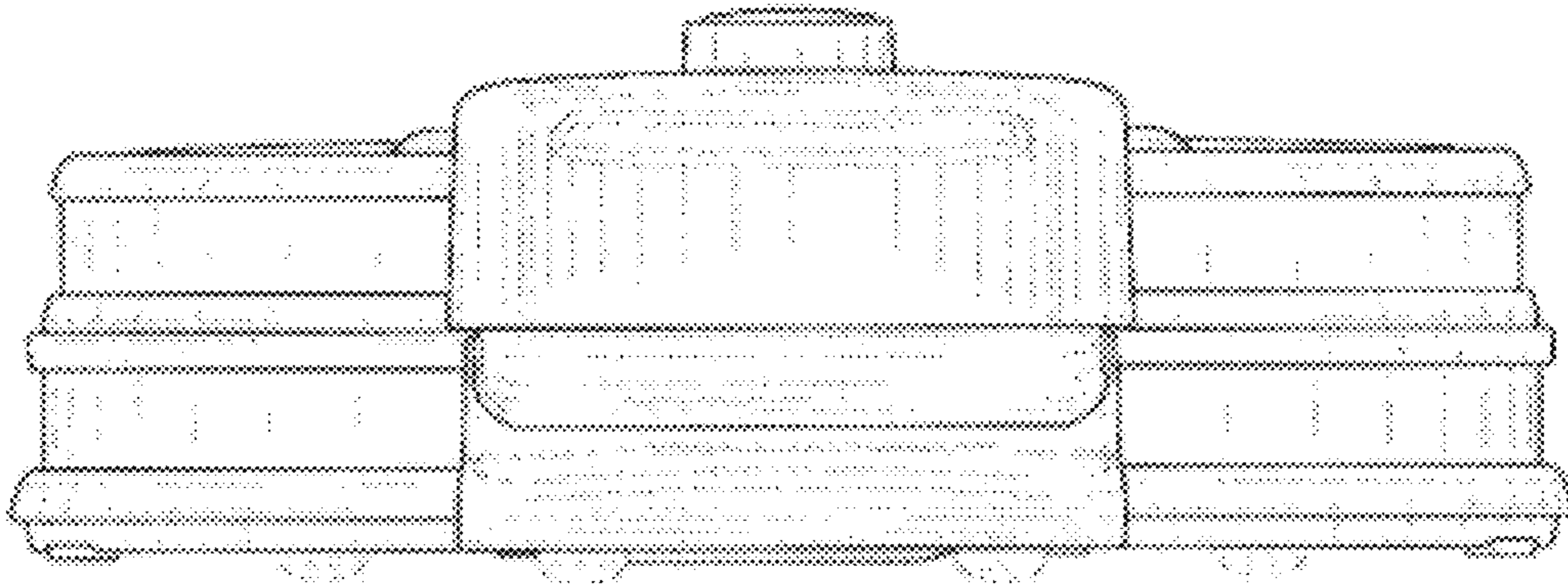

FIG. 2

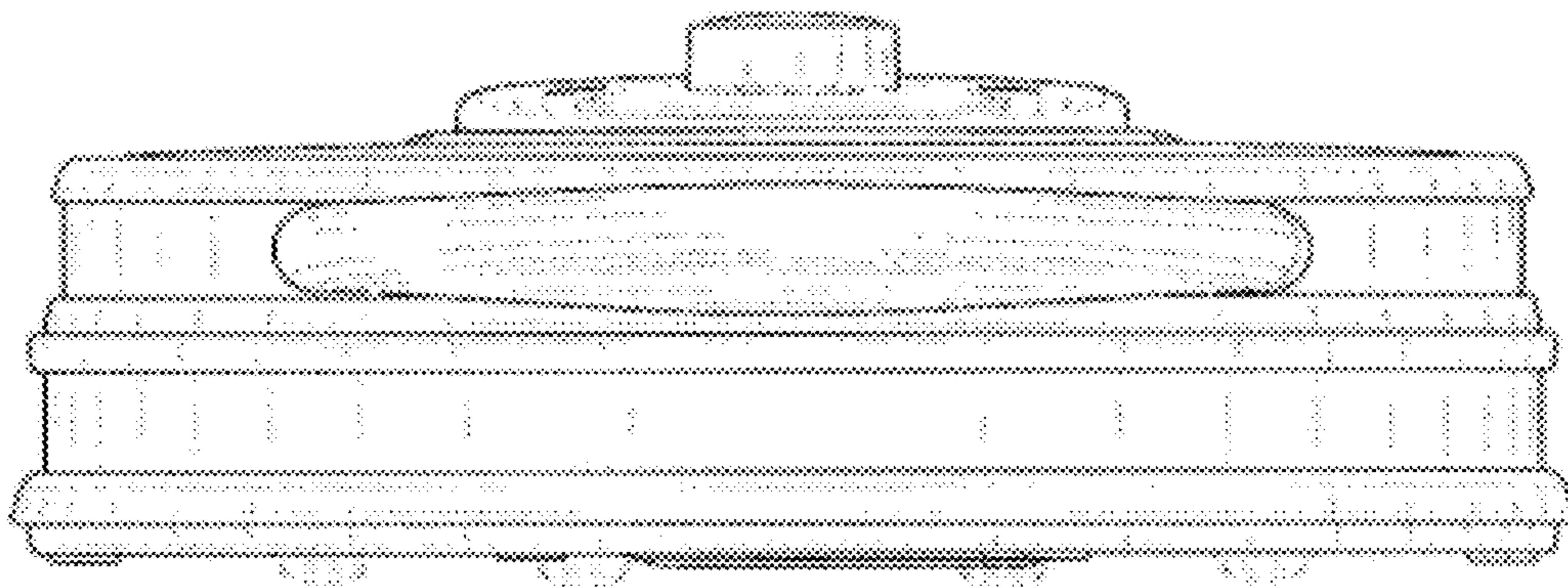

FIG. 3

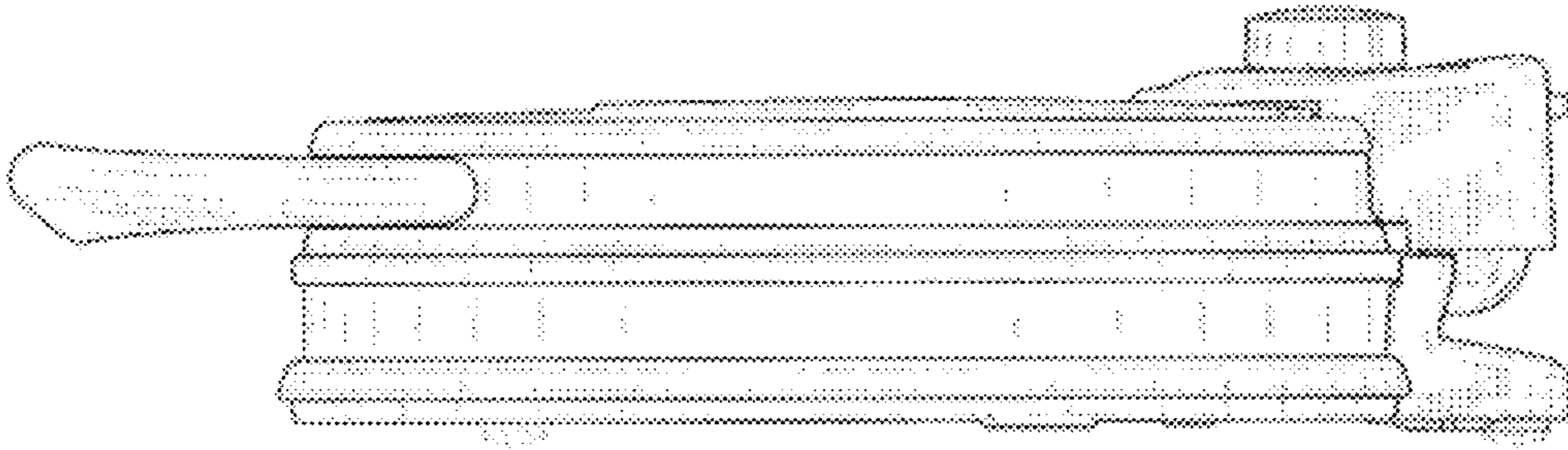

FIG. 4

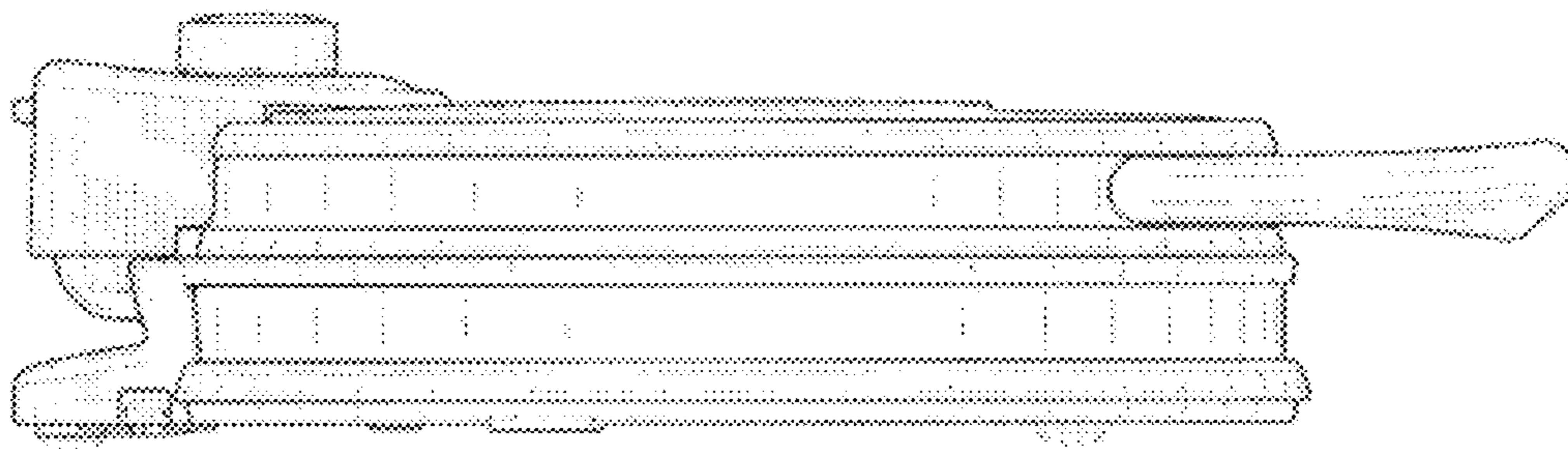

FIG. 5

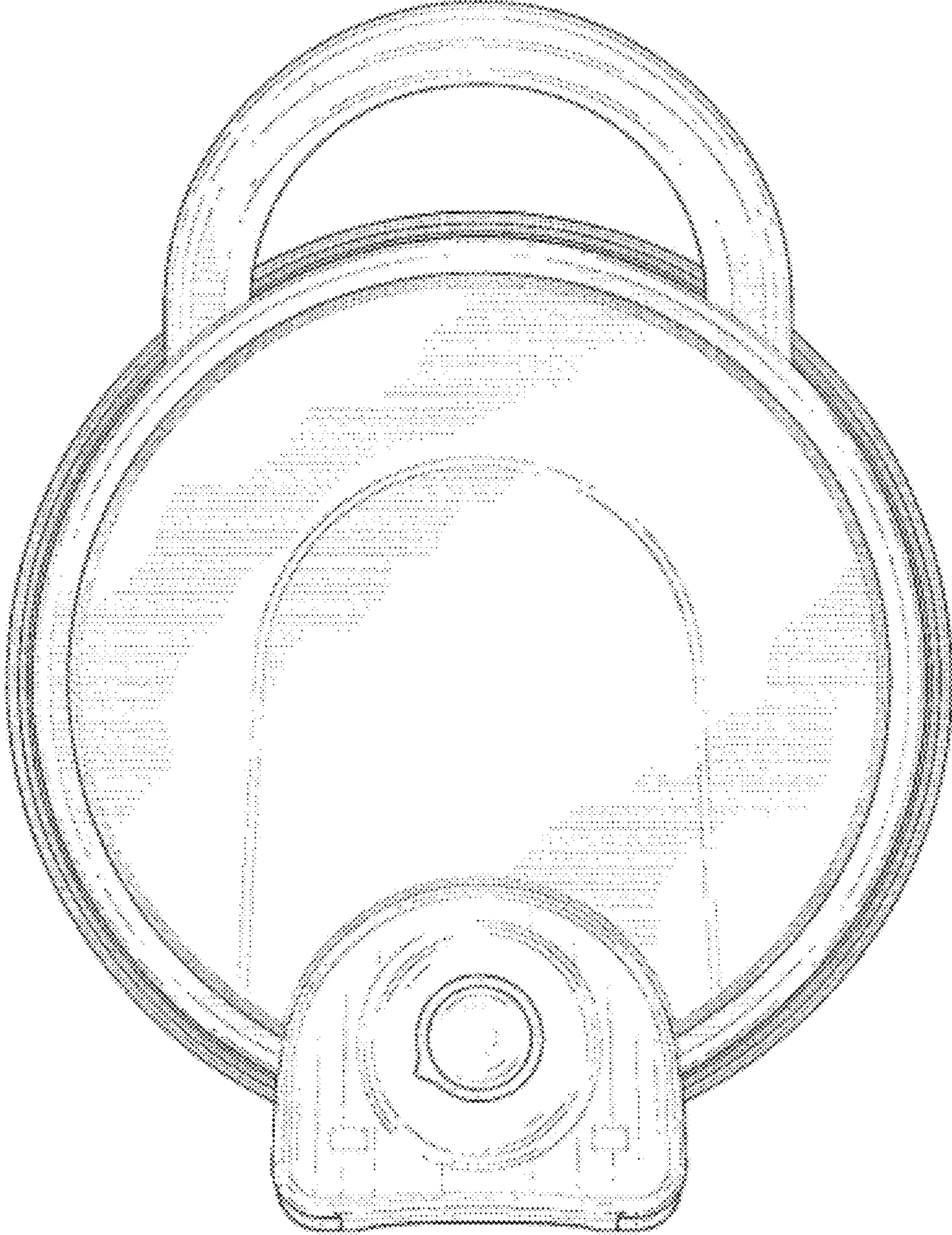

FIG. 6

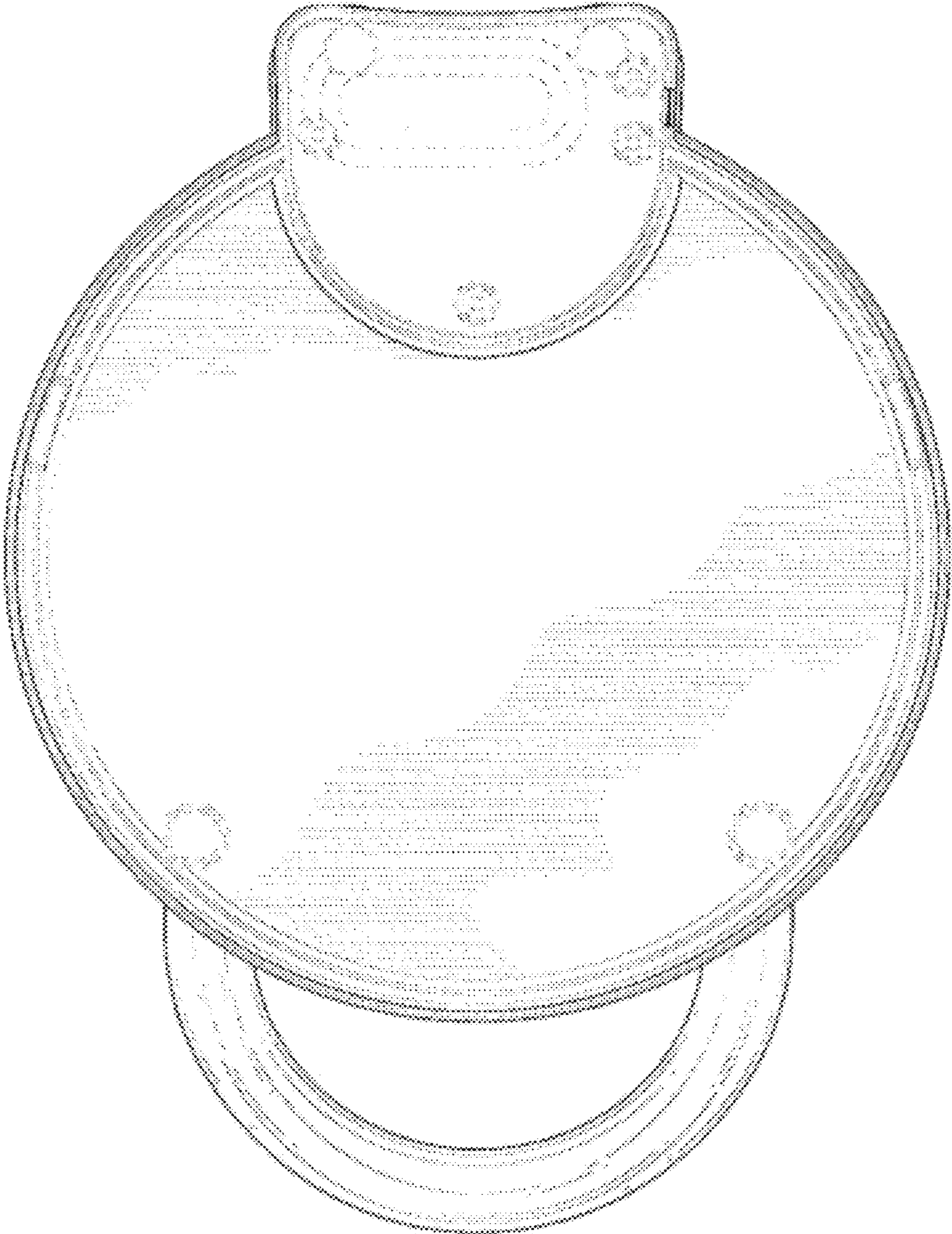

FIG. 7