

US00D677508S

(12) **United States Design Patent**
Margalit

(10) **Patent No.:** **US D677,508 S**

(45) **Date of Patent:** **** *Mar. 12, 2013**

(54) **SPORT TOWEL**

(76) Inventor: **Jon Margalit**, San Diego, CA (US)

(*) Notice: This patent is subject to a terminal disclaimer.

(**) Term: **14 Years**

(21) Appl. No.: **29/380,635**

(22) Filed: **Dec. 8, 2010**

(51) **LOC (9) Cl.** **06-06**

(52) **U.S. Cl.** **D6/608**

(58) **Field of Classification Search** D6/595,
D6/596, 601, 608; 5/417-420; 15/118, 209.1,
15/210.1

See application file for complete search history.

(56) **References Cited**

U.S. PATENT DOCUMENTS

2,754,532	A *	7/1956	Kanehl et al.	15/209.1
D258,035	S *	1/1981	Fenwick	D6/603
D363,404	S *	10/1995	Cute	D6/608
5,533,653	A	7/1996	Kaufman		
D378,483	S *	3/1997	Kiefer	D6/608
D379,893	S *	6/1997	Dilbeck	D6/602
5,817,379	A	10/1998	Rich		
D421,198	S *	2/2000	Surface	D6/608
6,058,530	A	5/2000	Wheeler		
6,186,155	B1	2/2001	Cheek		

D446,986	S *	8/2001	McCumber, Jr.	D6/608
D646,102	S *	10/2011	Margalit	D6/608
2006/0189463	A1	8/2006	Boice		
2007/0226934	A1	10/2007	Bohannon		
2008/0201882	A1	8/2008	Hay		

* cited by examiner

Primary Examiner — Janice Seeger

(74) *Attorney, Agent, or Firm* — Mark Wisnosky

(57) **CLAIM**

The ornamental design for a sport towel, as shown and described.

DESCRIPTION

FIG. 1 is a front view of a first embodiment of a sport towel. FIG. 2 is a back view of the embodiment shown in FIG. 1. FIG. 3 is a left side view of the embodiment shown in FIG. 1. FIG. 4 is a right side view of the embodiment shown in FIG. 1.

FIG. 5 is a top view of the embodiment shown in FIG. 1. FIG. 6 is a bottom view of the embodiment shown in FIG. 1. FIG. 7 is a view of the embodiment of FIG. 1 showing the sport towel in a rolled up or storage configuration; and, FIG. 8 is a perspective drawing of the embodiment of FIG. 1 showing the front view.

In the drawings, the broken lines indicate stitching.

The pattern shown on the rear surface in FIGS. 2 and 8 is continuous throughout.

1 Claim, 5 Drawing Sheets

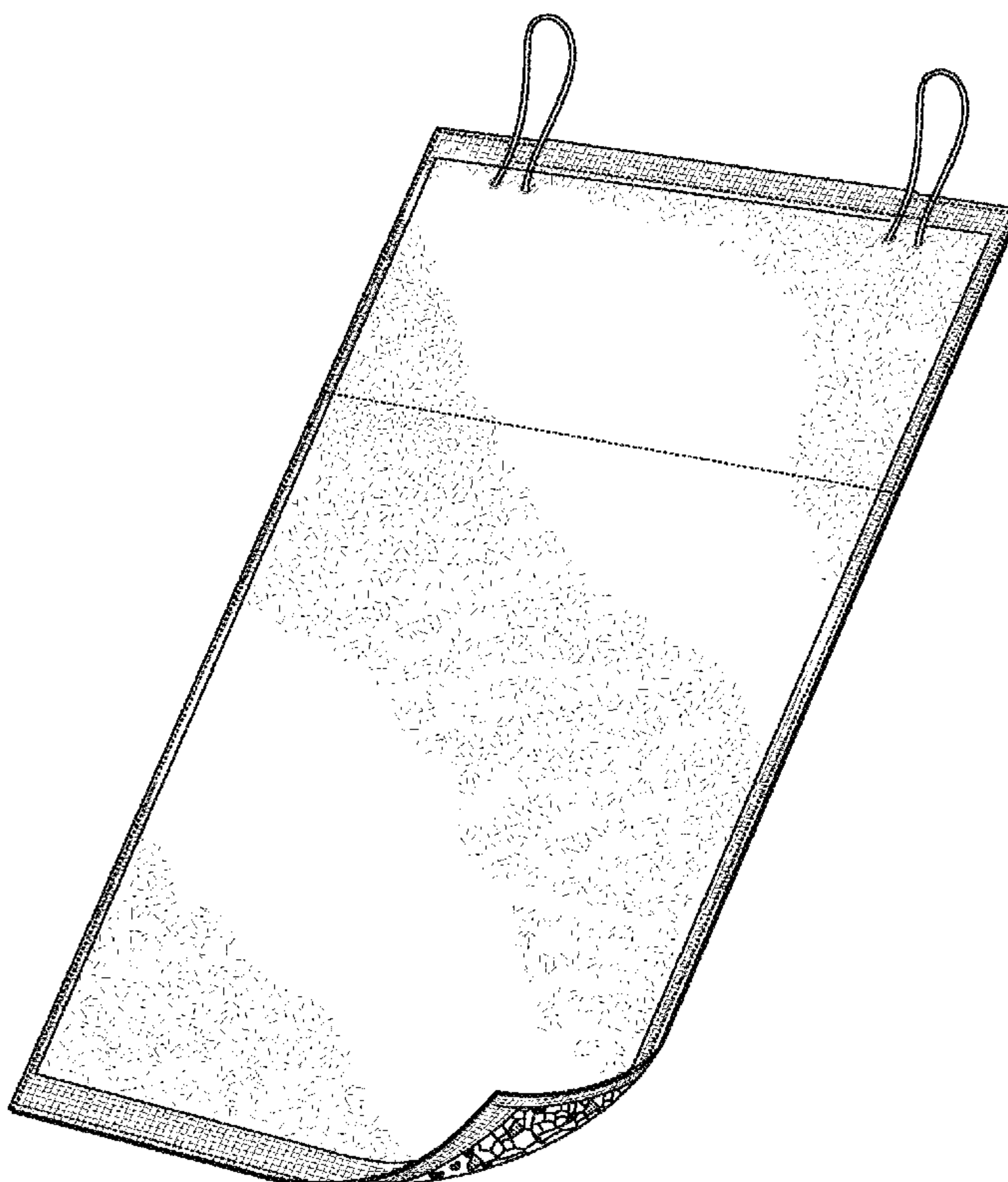

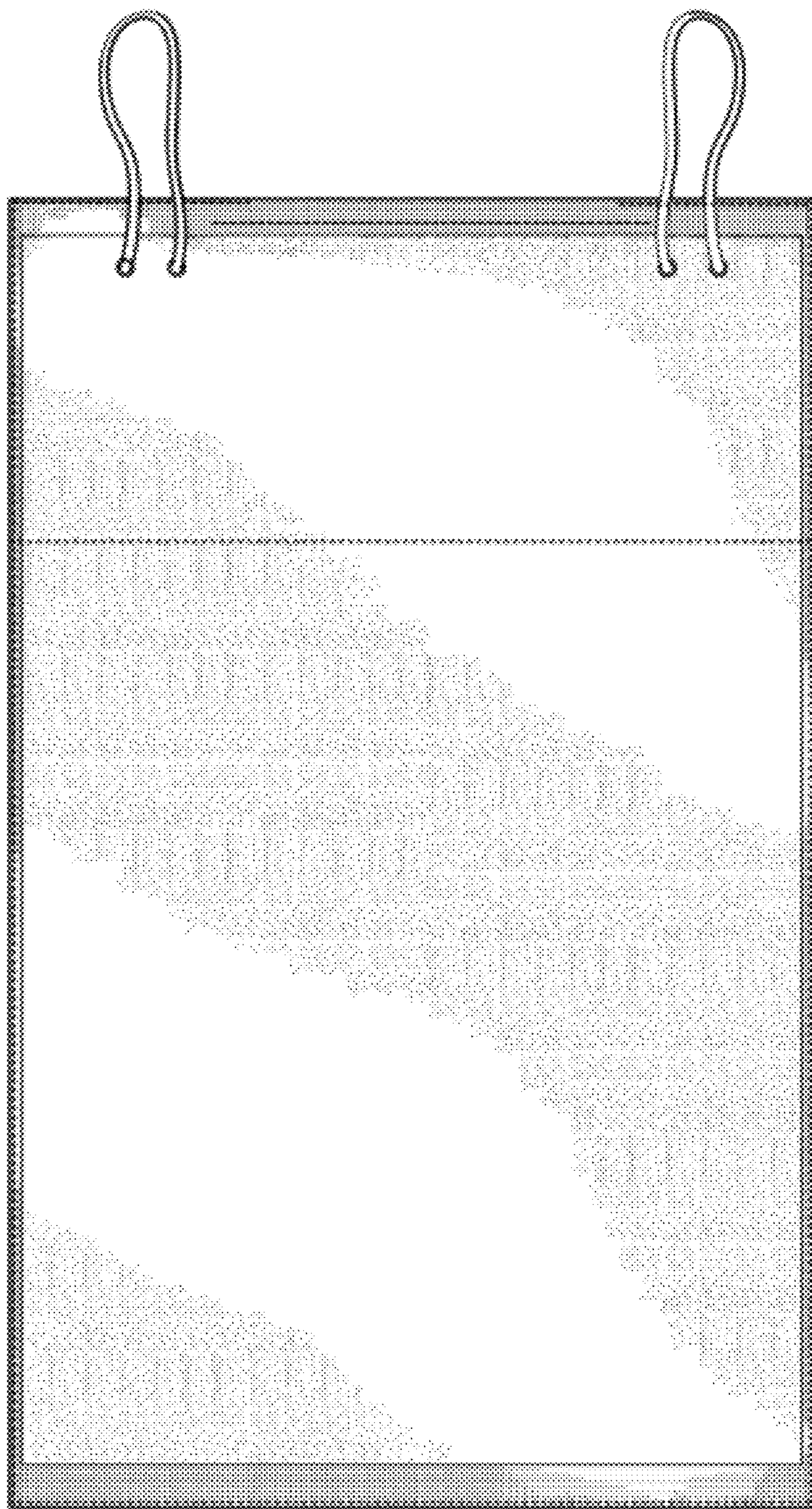

Figure 1

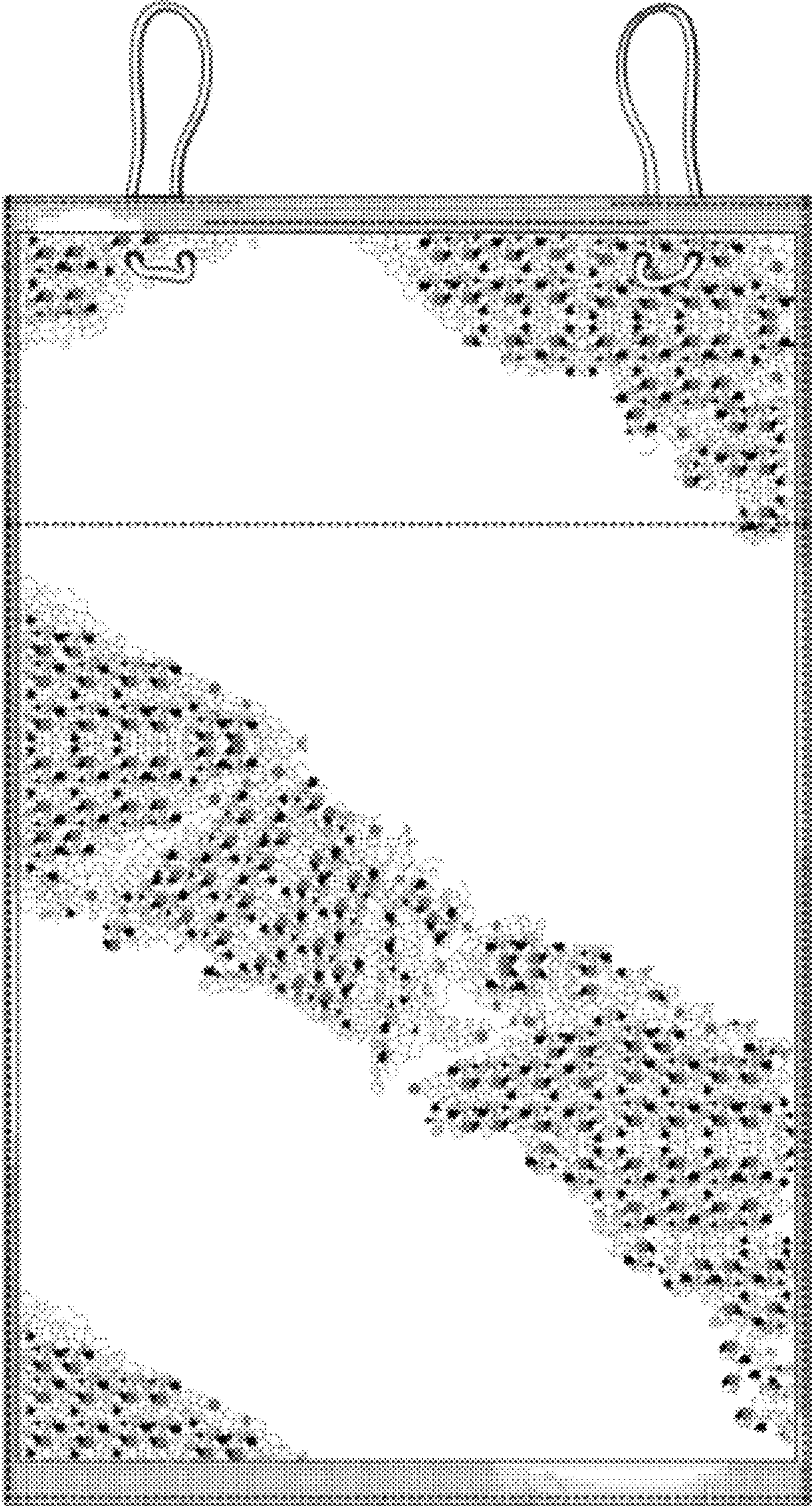

Figure 2

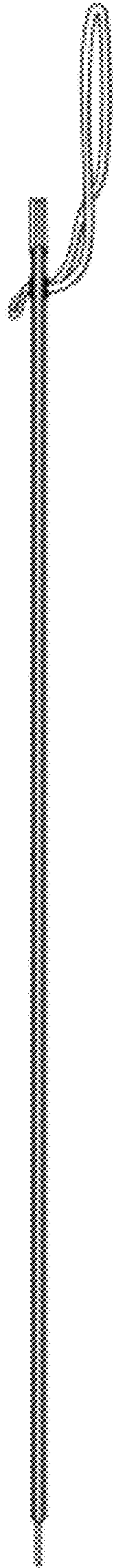

Figure 3

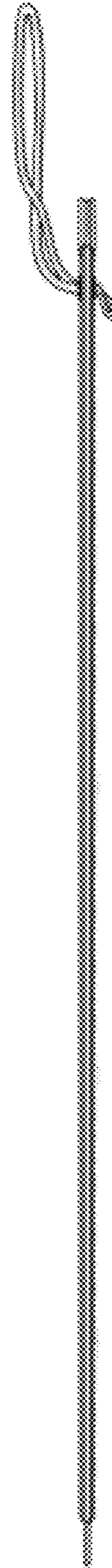

Figure 4



Figure 5



Figure 6

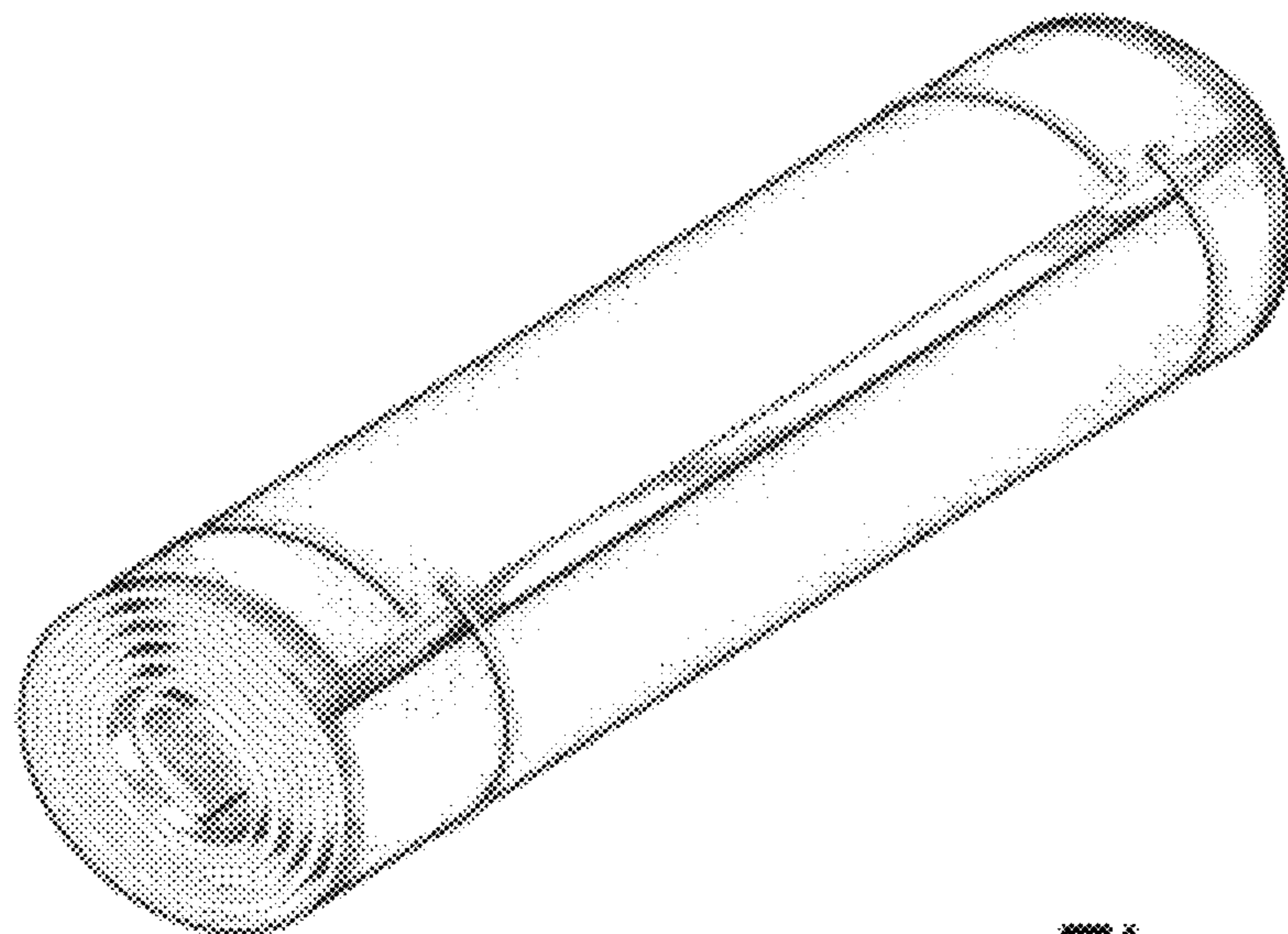

Figure 7

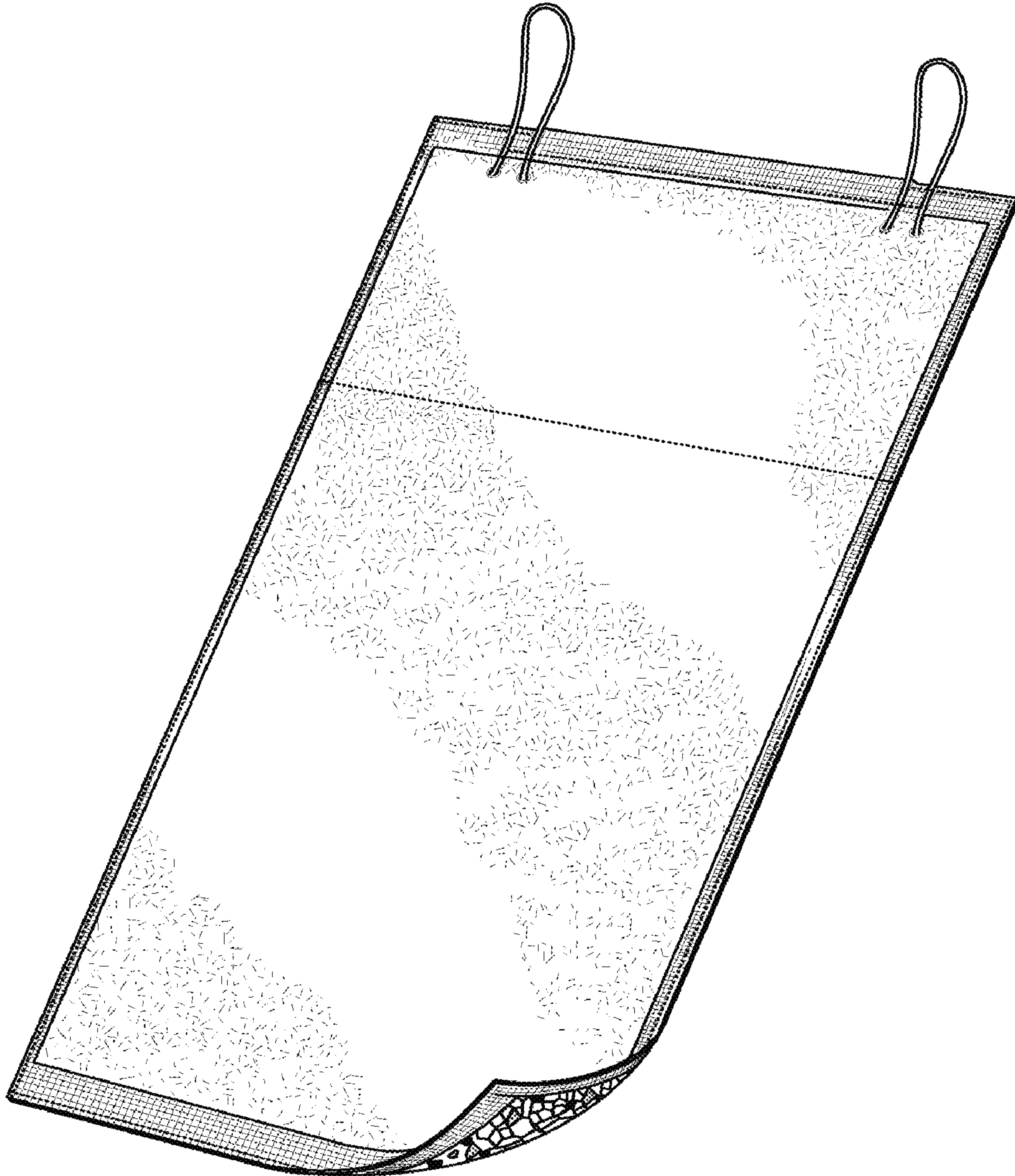

Figure 8