



US00D677470S

(12) **United States Design Patent**
Floyd et al.

(10) **Patent No.:** **US D677,470 S**
(45) **Date of Patent:** **** Mar. 12, 2013**

(54) **BRUSH**

(75) Inventors: **Brian Lee Floyd**, Cincinnati, OH (US);
Brandon Albert Lynne, Daly City, CA
(US); **Jesse Samuel Madsen**, Oakland,
CA (US)

(73) Assignee: **The Gillette Company**, Boston, MA
(US)

(**) Term: **14 Years**

(21) Appl. No.: **29/431,212**

(22) Filed: **Sep. 5, 2012**

(51) **LOC (9) Cl.** **04-02**

(52) **U.S. Cl.** **D4/127**

(58) **Field of Classification Search** D4/127,
D4/135, 138; D28/7; 15/143.1, 159.1, 160,
15/191.1-195, 198; 132/286, 289, 290, 293,
132/294, 313, 317, 320

See application file for complete search history.

(56) **References Cited**

U.S. PATENT DOCUMENTS

D37,340 S *	2/1905	Thompson	D4/127
D53,980 S *	11/1919	Behrman	D4/127
1,674,972 A *	6/1928	Kendrick et al.	401/270
1,783,754 A *	12/1930	Stepelton	401/175
1,810,544 A	6/1931	Trupiano		

1,909,146 A	5/1933	Bohanan		
2,145,570 A *	1/1939	Miettunen	401/176
2,681,462 A	6/1954	Turnes		
D347,326 S *	5/1994	Coleman	D4/135
D564,232 S	3/2008	Schulz		
2009/0089949 A1 *	4/2009	Mink et al.	15/160

FOREIGN PATENT DOCUMENTS

KR	104863 S *	7/1990
KR	30-0638846 S *	4/2012

* cited by examiner

Primary Examiner — Melanie H Tung

Assistant Examiner — Lavone D Tabor

(74) *Attorney, Agent, or Firm* — Kevin C. Johnson; Steven
W. Miller

(57) **CLAIM**

The ornamental design for a brush, as shown and described.

DESCRIPTION

FIG. 1 is a perspective view of a brush of the present inven-
tion;

FIG. 2 is a front view thereof;

FIG. 3 is a rear view thereof;

FIG. 4 is a right side view thereof;

FIG. 5 is a left side view thereof;

FIG. 6 is a top view thereof; and,

FIG. 7 is a bottom view thereof.

1 Claim, 6 Drawing Sheets

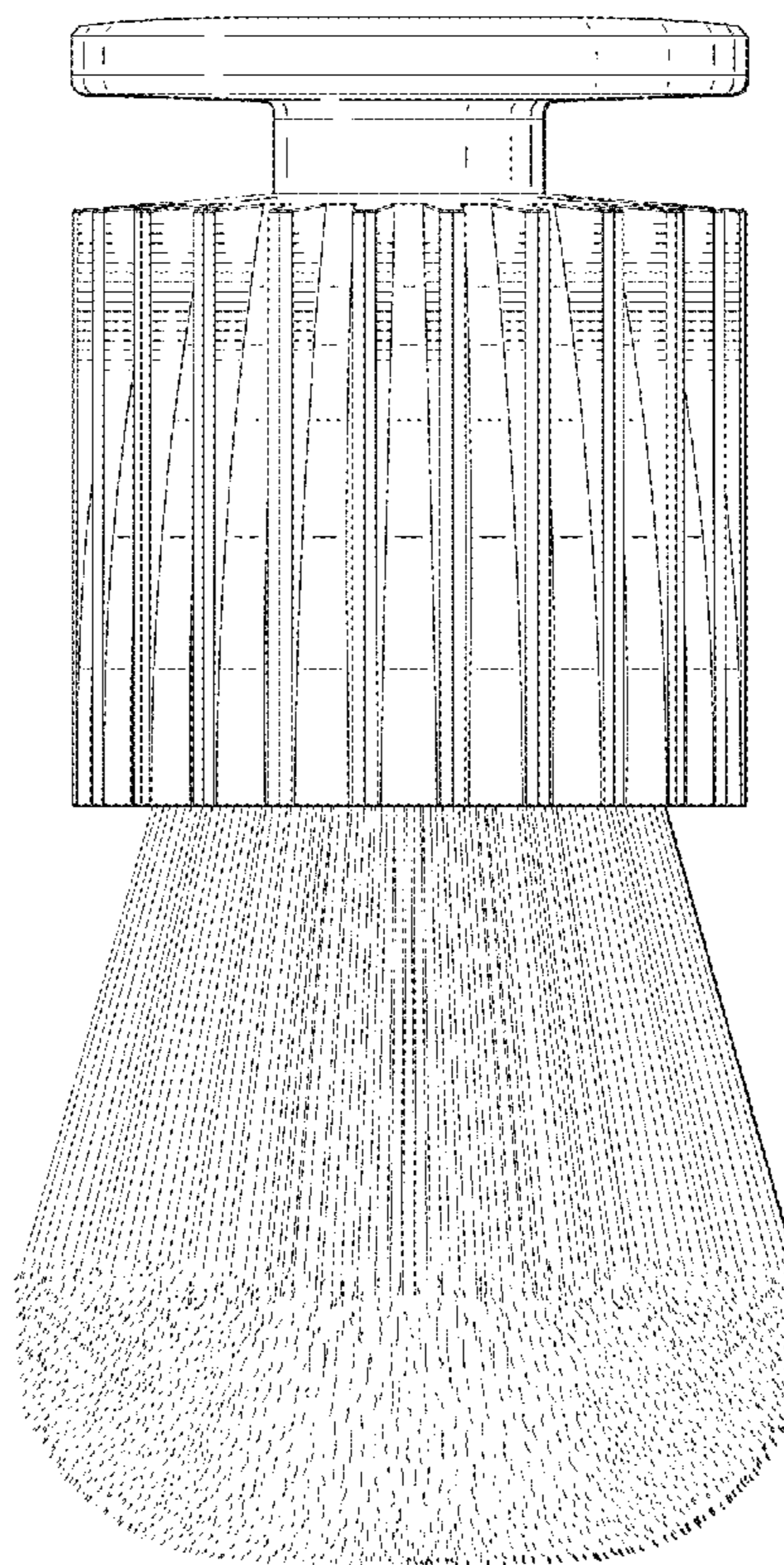
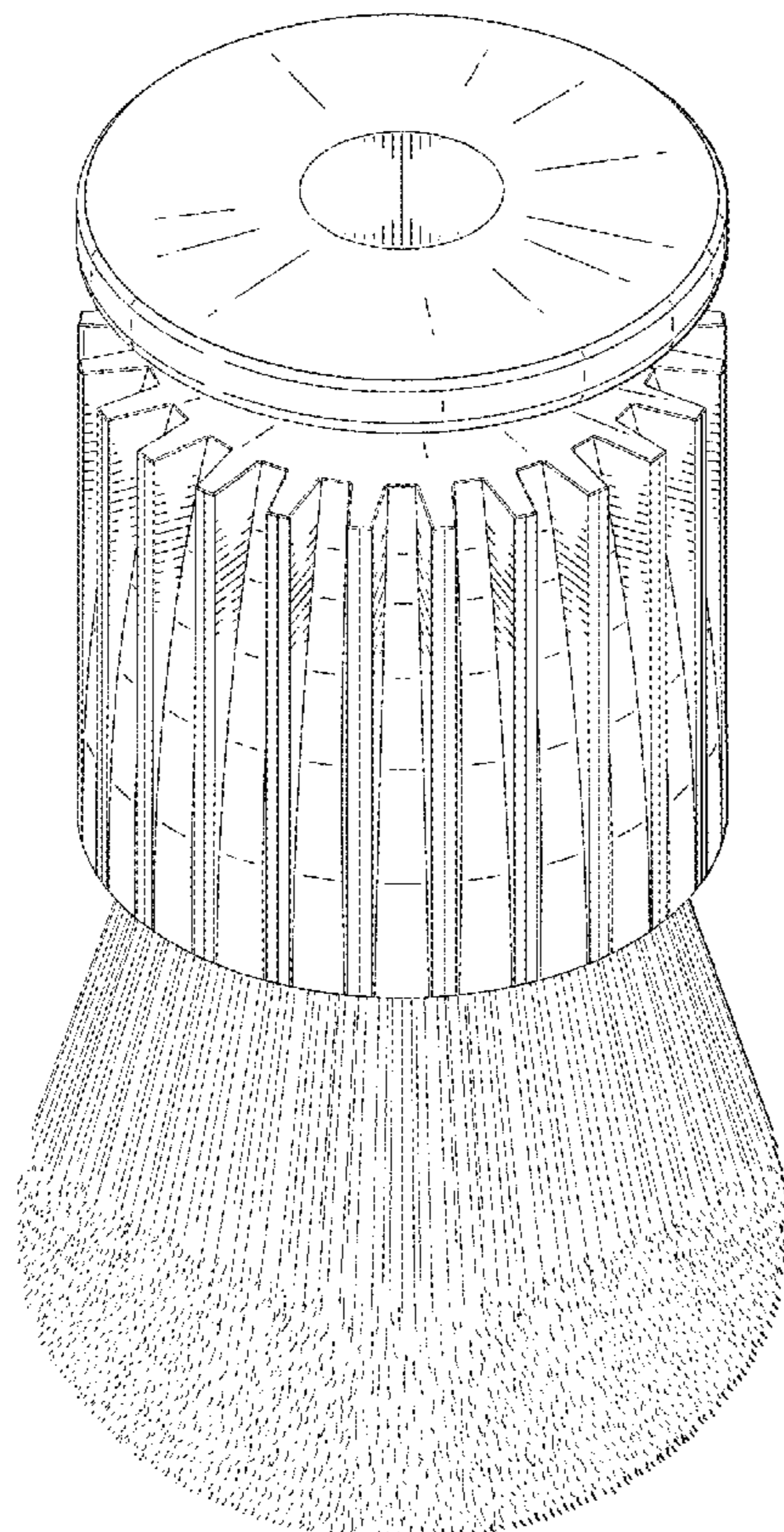

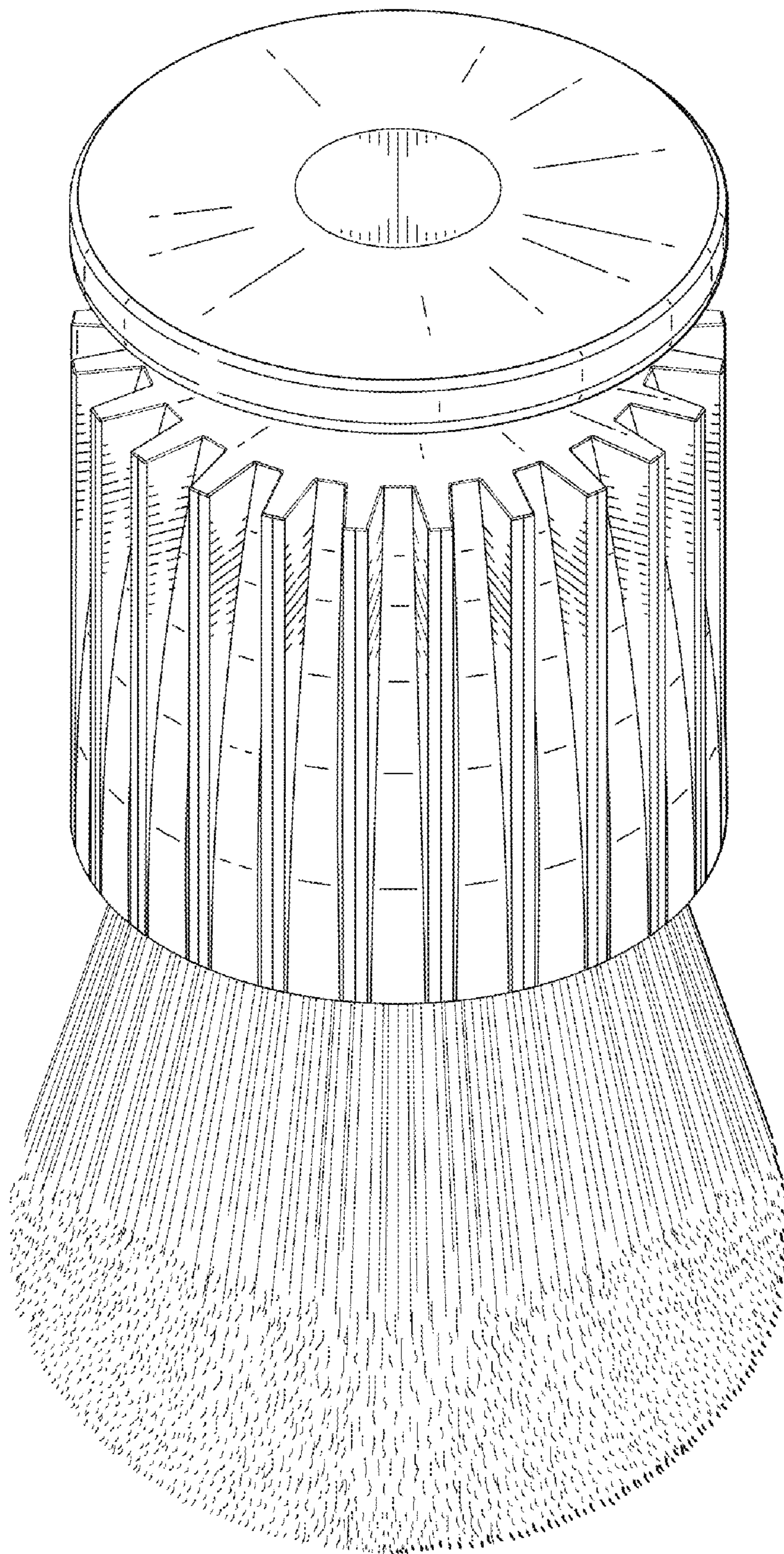

FIG. 1

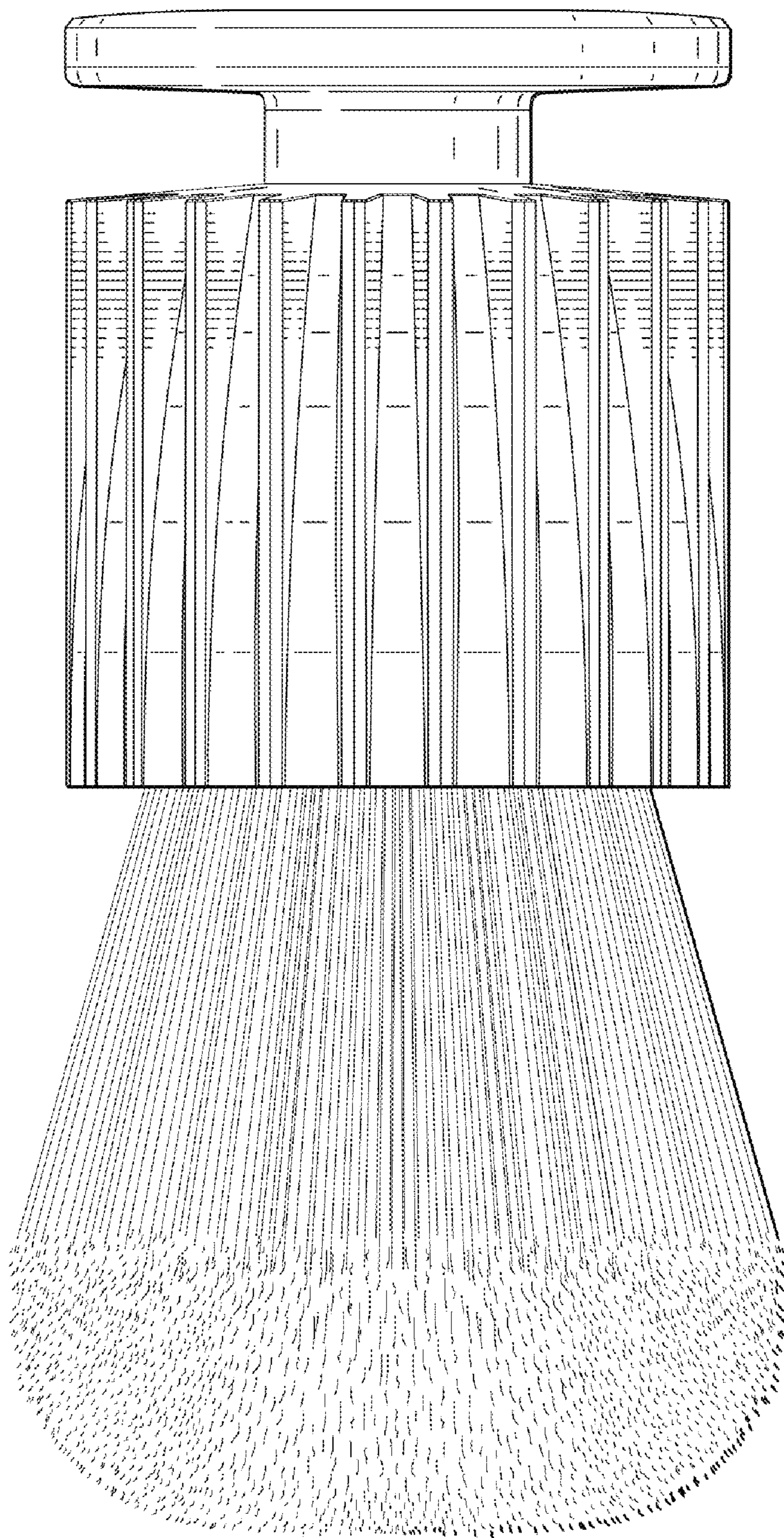

FIG. 2

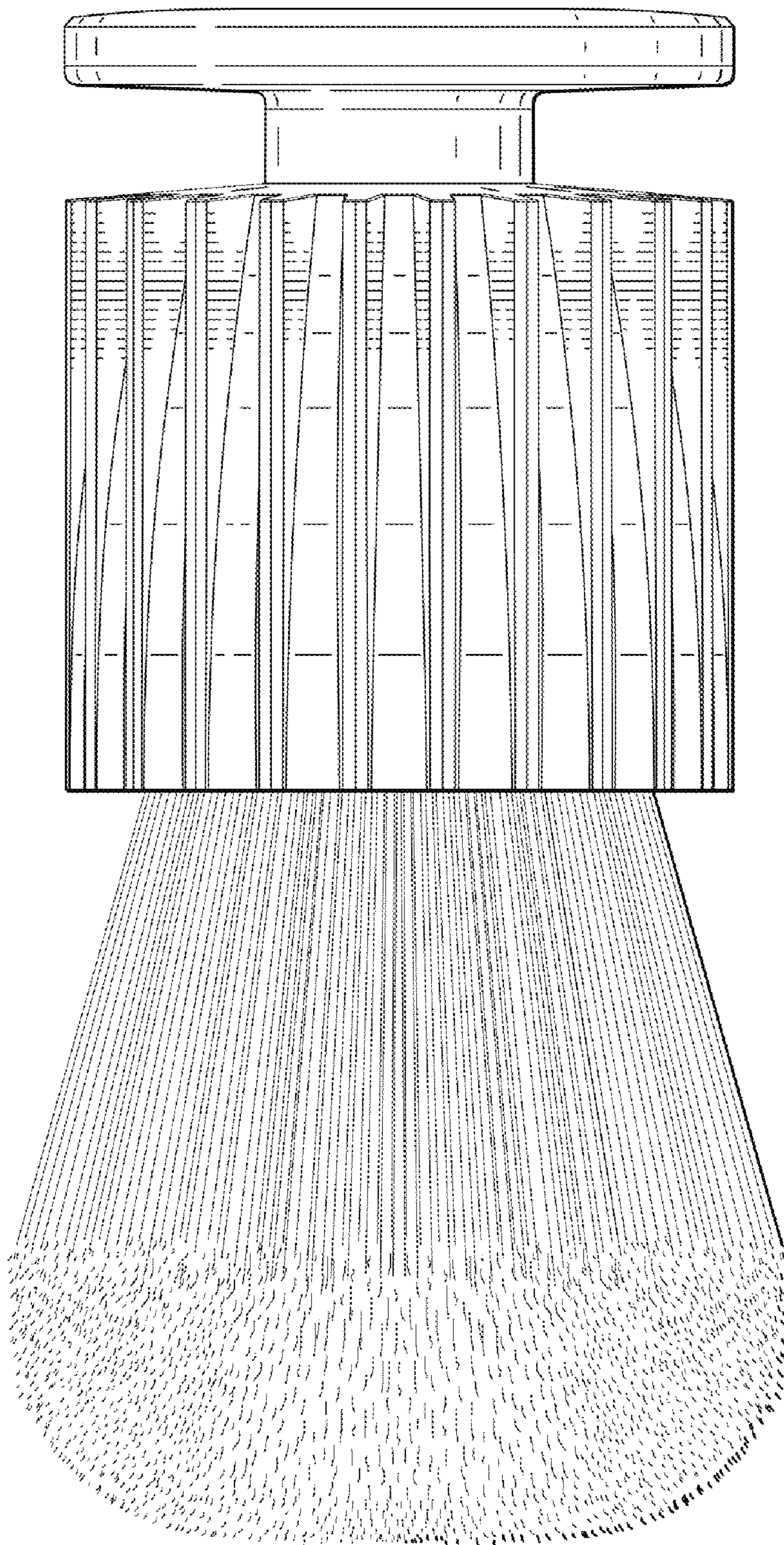

FIG. 3

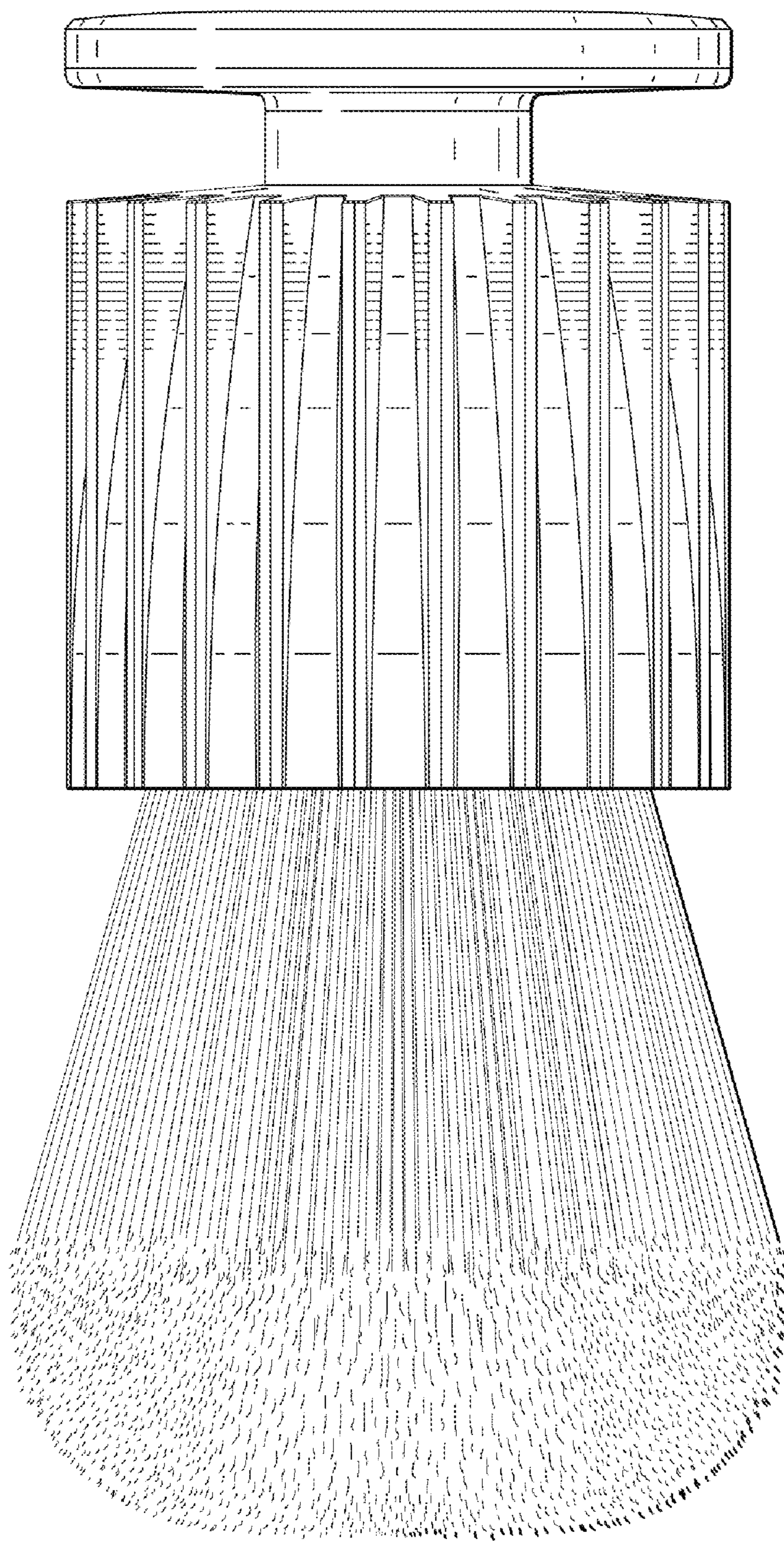

FIG. 4

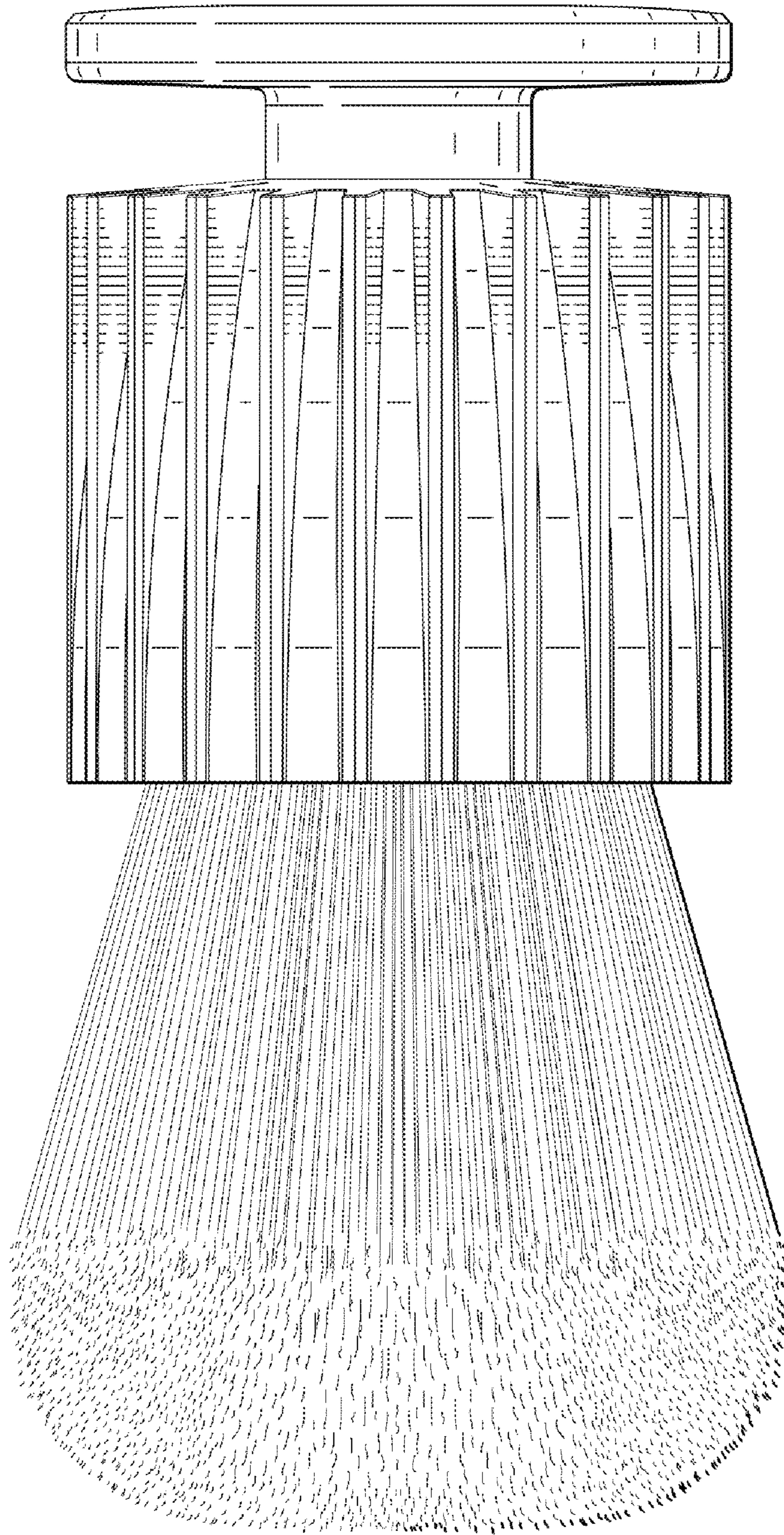

FIG. 5

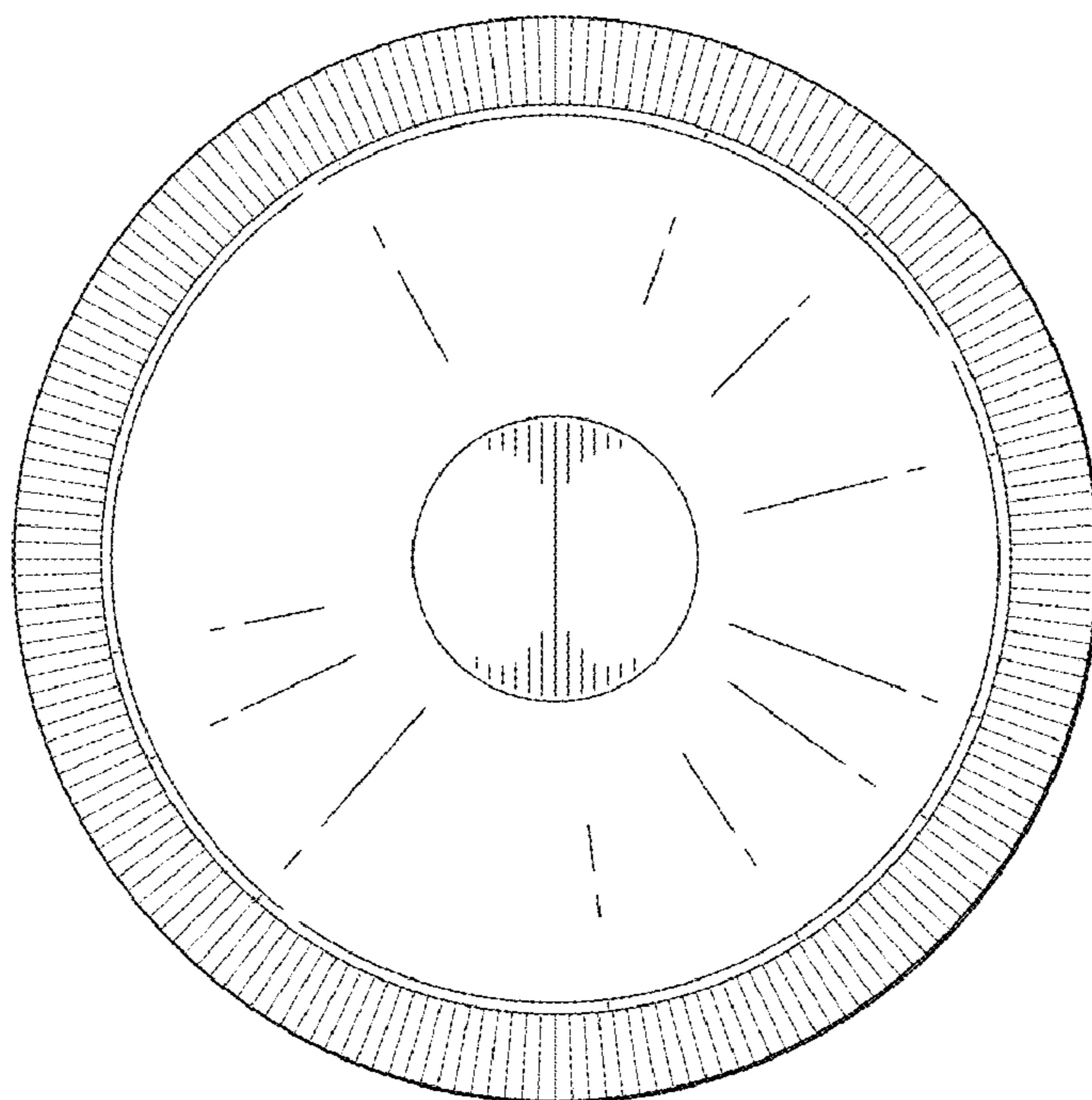

FIG. 6

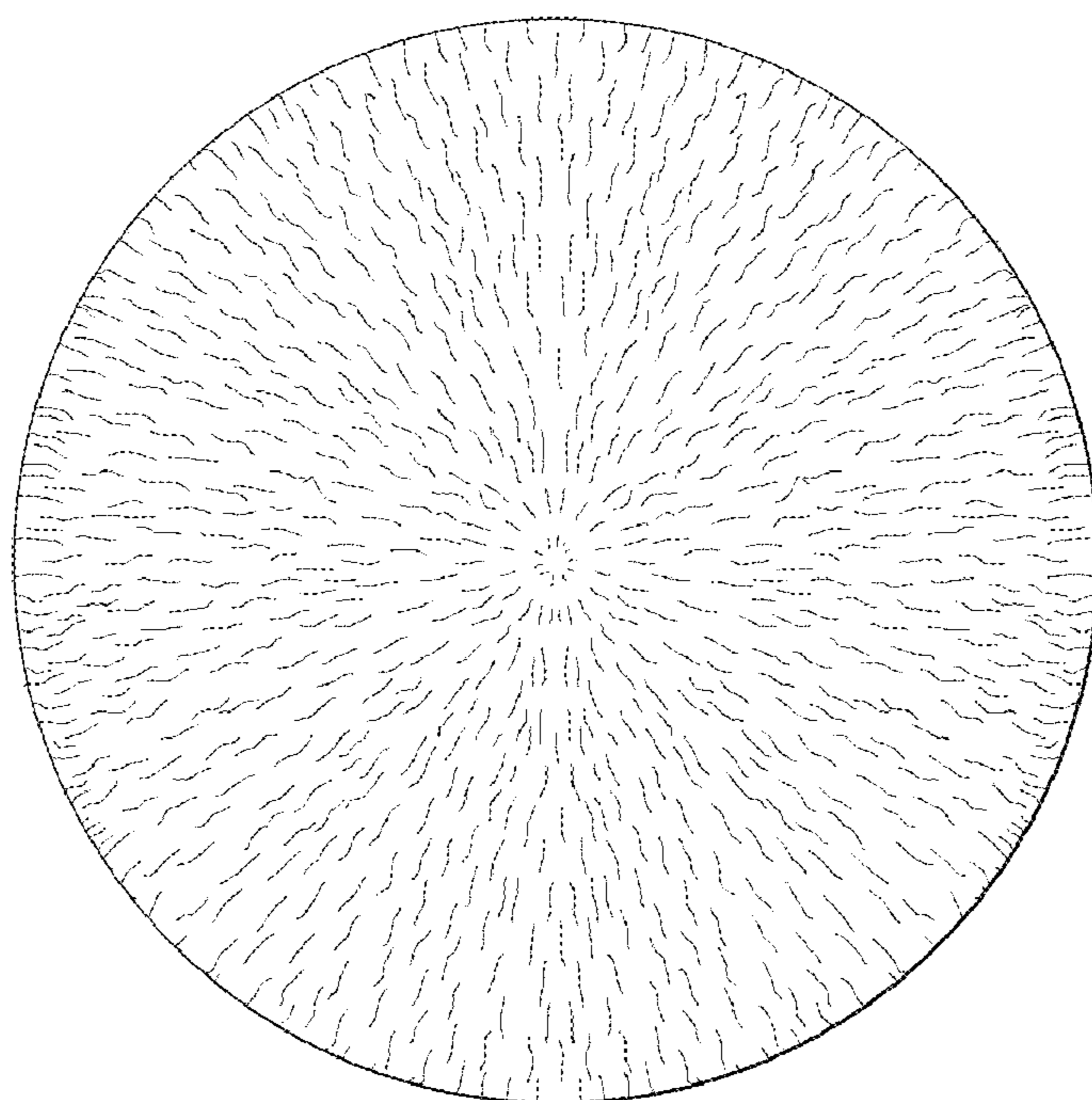

FIG. 7