



US00D677469S

(12) **United States Design Patent**
Seehoff et al.

(10) **Patent No.:** **US D677,469 S**
(45) **Date of Patent:** **** Mar. 12, 2013**

(54) **SCREEN CLEANER**

(75) Inventors: **Gary Stanley Seehoff**, Encino, CA
(US); **Huy Kha Nguyen**, Anaheim, CA
(US); **Jesse Clemmer**, Lake Forest, CA
(US)

(73) Assignee: **Evrholder Products, LLC**, Anaheim,
CA (US)

(**) Term: **14 Years**

(21) Appl. No.: **29/424,886**

(22) Filed: **Jun. 16, 2012**

(51) **LOC (9) Cl.** **08-05**

(52) **U.S. Cl.** **D4/122**

(58) **Field of Classification Search** D4/122,
D4/199; D6/317, 566; D8/370, 373, 303,
D8/107; 15/27, 230.11; 211/106, 106.01;
248/302; 492/13, 16, 17, 19; 16/422, 430,
16/431, 902, DIG. 12, DIG. 18, DIG. 19

See application file for complete search history.

(56) **References Cited**

U.S. PATENT DOCUMENTS

D244,506 S * 5/1977 Yankee D32/51
D248,055 S * 5/1978 MacGregor D18/58
4,302,122 A * 11/1981 Moya 401/268

D280,784 S * 10/1985 deVreeze et al. D4/122
D292,450 S * 10/1987 Moon D4/122
D358,908 S * 5/1995 Rawski D30/158
D562,559 S * 2/2008 Murray D4/102
D612,155 S * 3/2010 Falkins et al. D4/102
D627,565 S * 11/2010 Tyce et al. D4/102

* cited by examiner

Primary Examiner — Austin Murphy

(57) **CLAIM**
The ornamental design for a screen cleaner, as shown and described.

DESCRIPTION

FIG. 1 illustrates a top view of the claimed design for a screen cleaner;
FIG. 2 illustrates a left-side view thereof;
FIG. 3 illustrates a right-side view thereof;
FIG. 4 illustrates a bottom view thereof;
FIG. 5 illustrates a front view thereof;
FIG. 6 illustrates a rear view thereof;
FIG. 7 illustrates a cross-sectional view thereof, taken along line A-A of FIG. 2; and,
FIG. 8 illustrates a perspective view thereof.
The broken line showing an exemplary handle is for illustrative purposes only and forms no part of the claimed design.

1 Claim, 8 Drawing Sheets

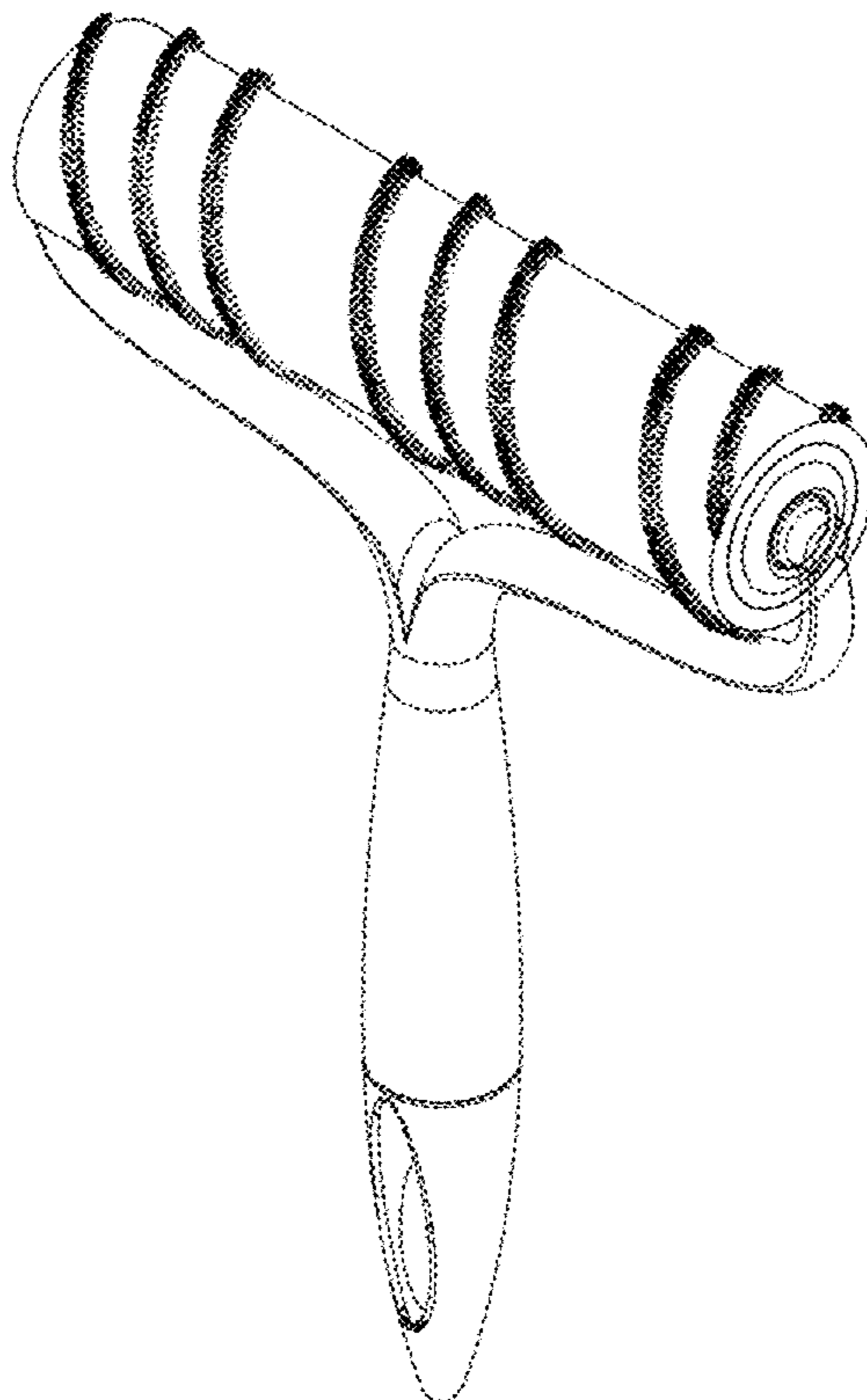

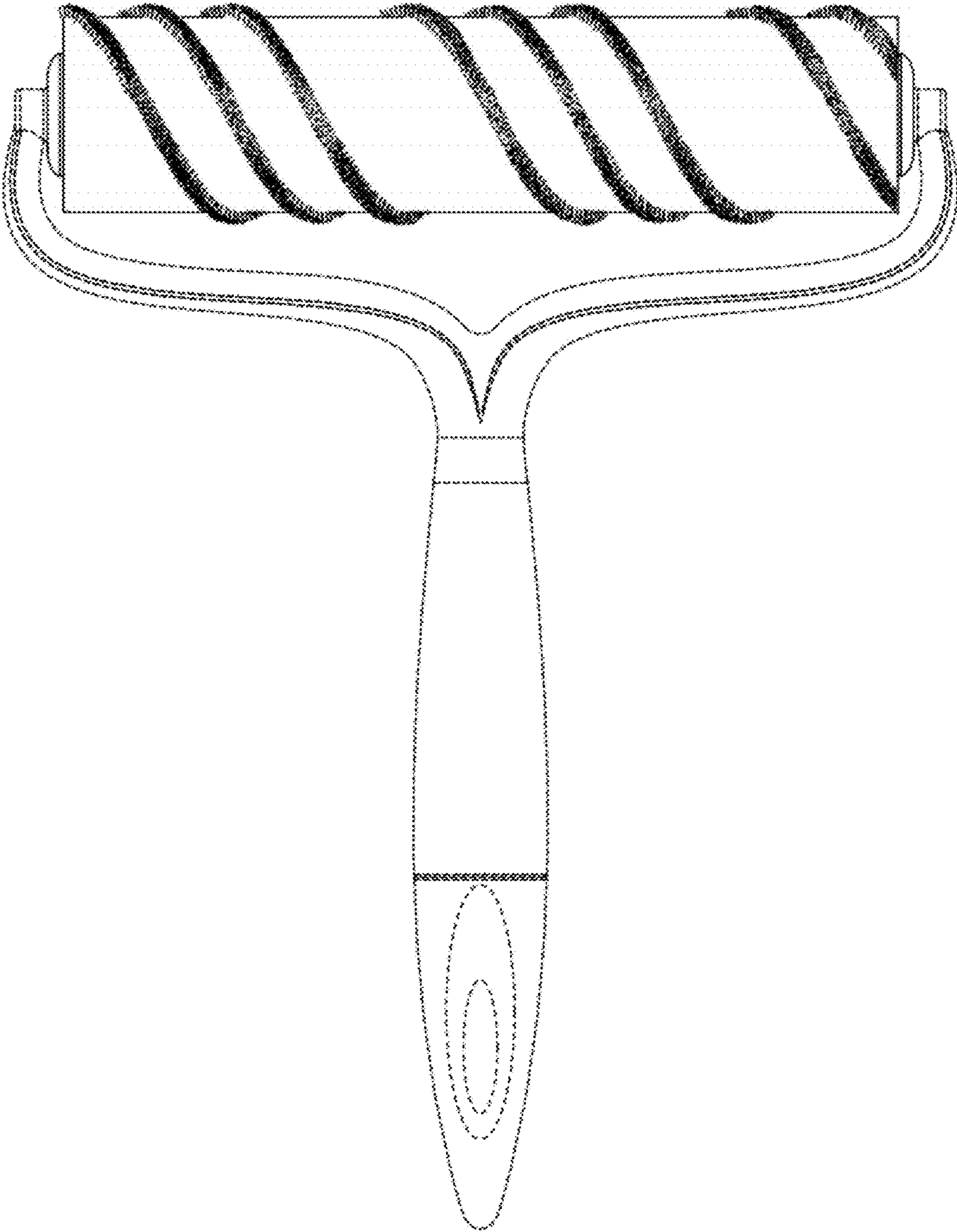
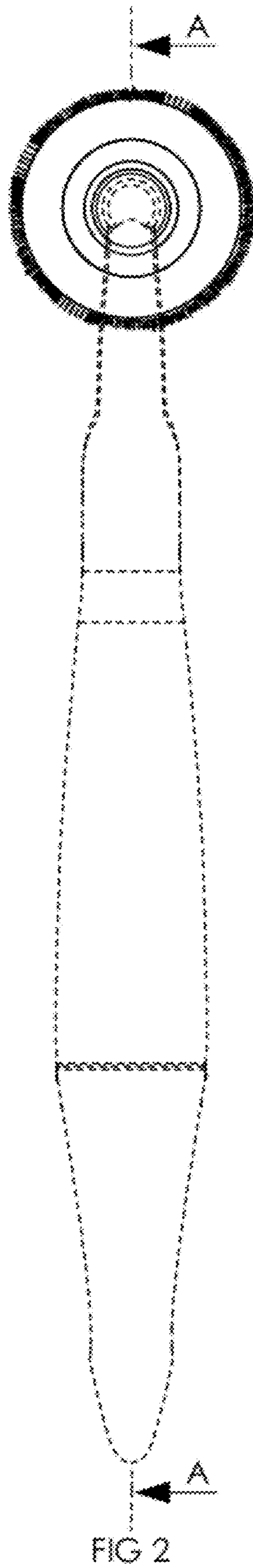

FIG 1



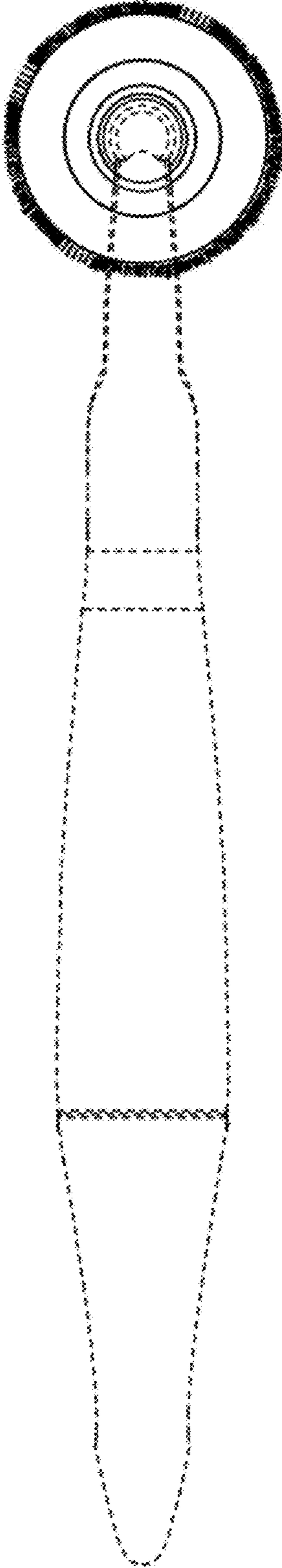

FIG 3

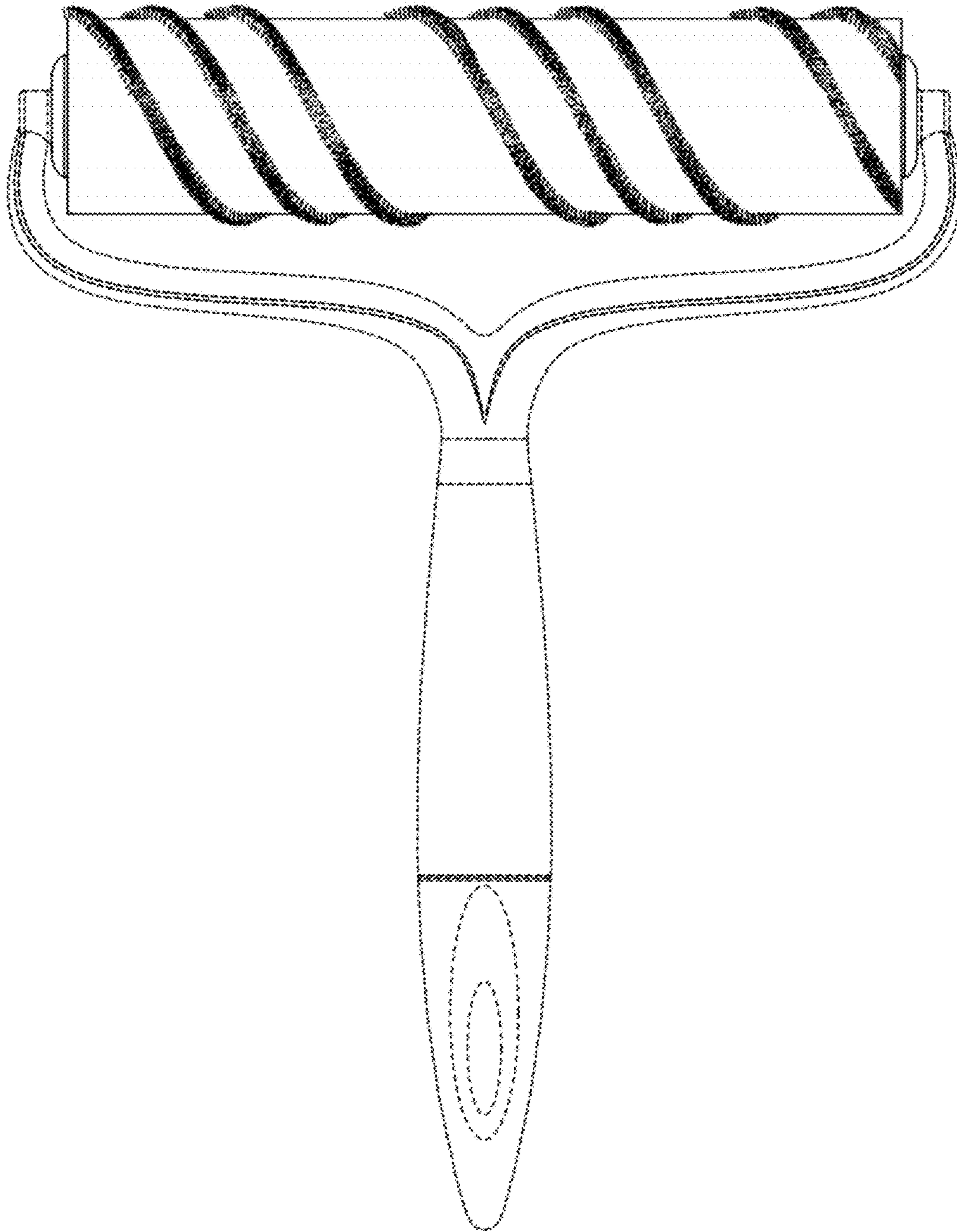

FIG 4



FIG 5

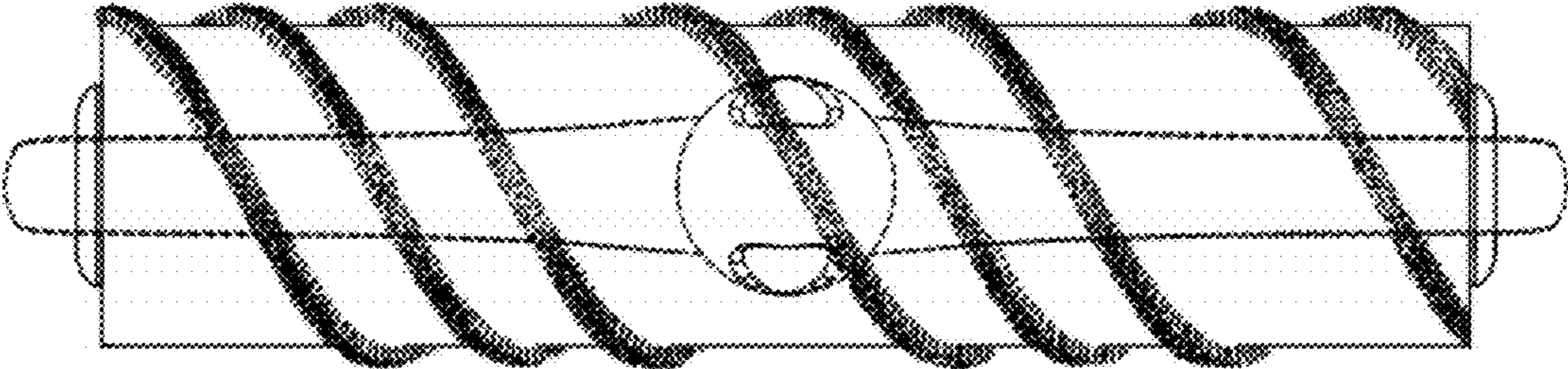

FIG 6

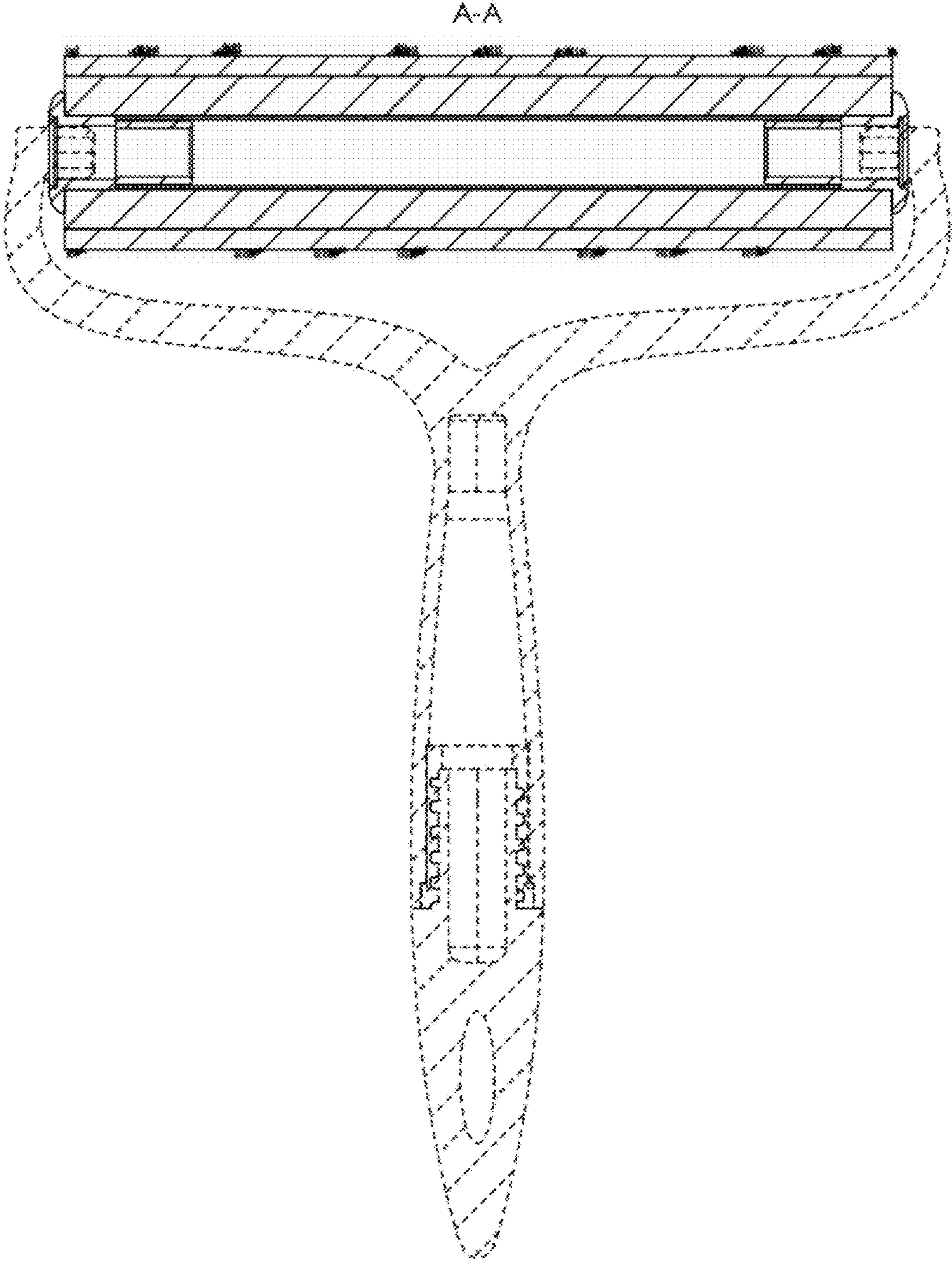

FIG 7

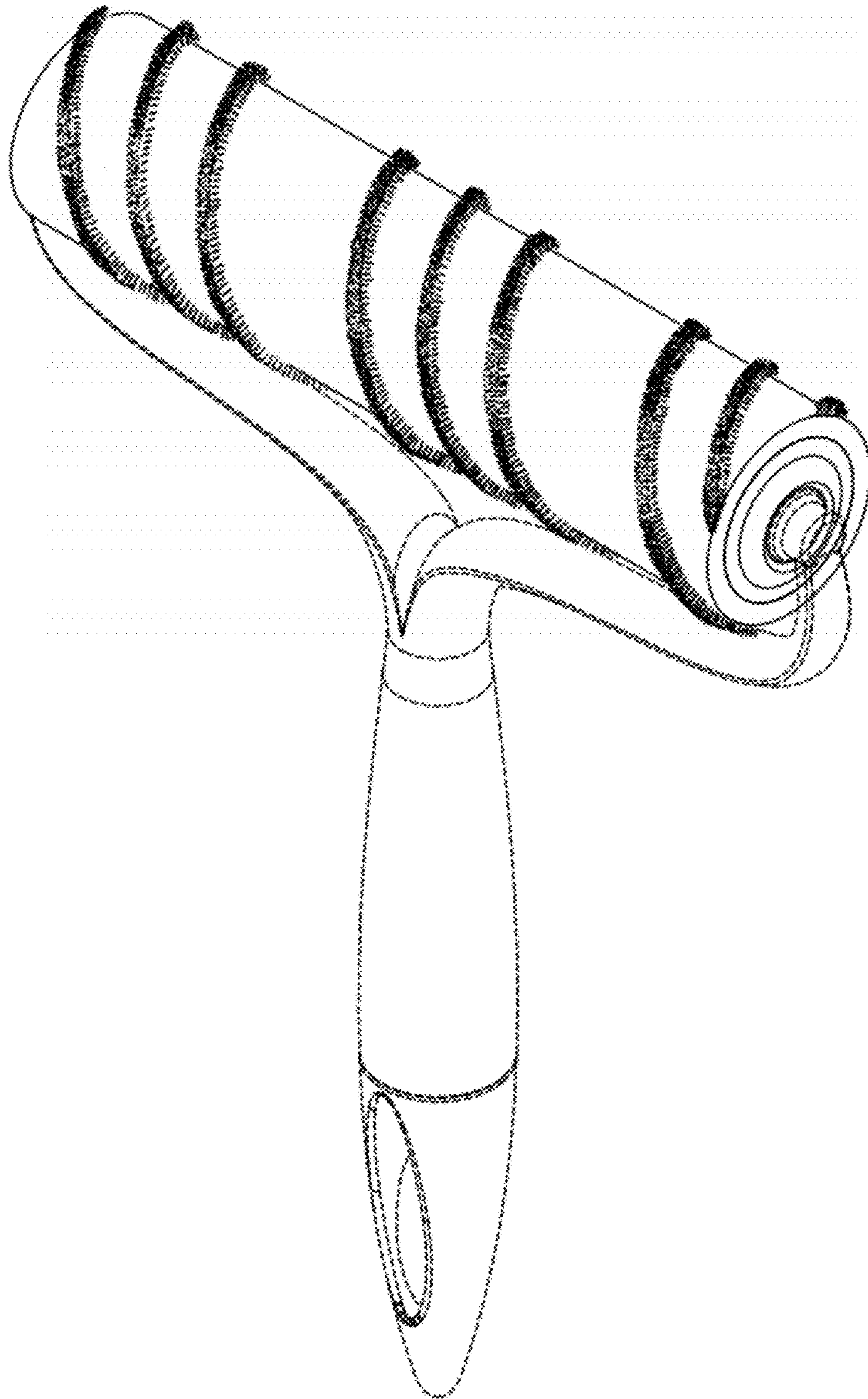

FIG 8