



US00D677467S

(12) **United States Design Patent**
Ford

(10) **Patent No.:** **US D677,467 S**
(45) **Date of Patent:** **** Mar. 12, 2013**

(54) **CHAIN SHEATH**

(76) Inventor: **Thomas C. Ford**, Los Angeles, CA (US)

(**) Term: **14 Years**

(21) Appl. No.: **29/401,263**

(22) Filed: **Sep. 9, 2011**

(51) **LOC (9) Cl.** **03-01**

(52) **U.S. Cl.** **D3/318**

(58) **Field of Classification Search** D3/232–233,
D3/240–246, 318, 324; 150/100, 103–110,
150/113–114, 117–119

See application file for complete search history.

(56) **References Cited**

U.S. PATENT DOCUMENTS

D579,655 S	*	11/2008	Gonzalez	D3/232
D581,158 S	*	11/2008	Hermann	D3/246
D582,666 S	*	12/2008	Javits, Jr.	D3/232
D590,593 S	*	4/2009	Gonzalez	D3/232
D628,803 S	*	12/2010	Gonzalez	D3/318

D628,804 S * 12/2010 Gonzalez D3/318

* cited by examiner

Primary Examiner — Holly Baynham

(74) *Attorney, Agent, or Firm* — Goodwin Procter LLP

(57) **CLAIM**

The ornamental design for a chain sheath, as shown and described.

DESCRIPTION

FIG. 1 is a top plan view of the chain sheath;
FIG. 2 is an enlarged front perspective view of a portion of the chain sheath;
FIG. 3 is a front view of a portion of the chain sheath;
FIG. 4 is a rear view of a portion of the chain sheath;
FIG. 5 is a perspective view of an end of the chain sheath; and,
FIG. 6 is a top view of a portion of the chain sheath.
The broken lines shown in the drawings of a portion of a handbag and associated chain handle are for illustrative purposes only and form no part of the claimed design. The broken away symbols in the drawings indicate that any portion of the article beyond what is shown forms no part of the claimed design.

1 Claim, 6 Drawing Sheets

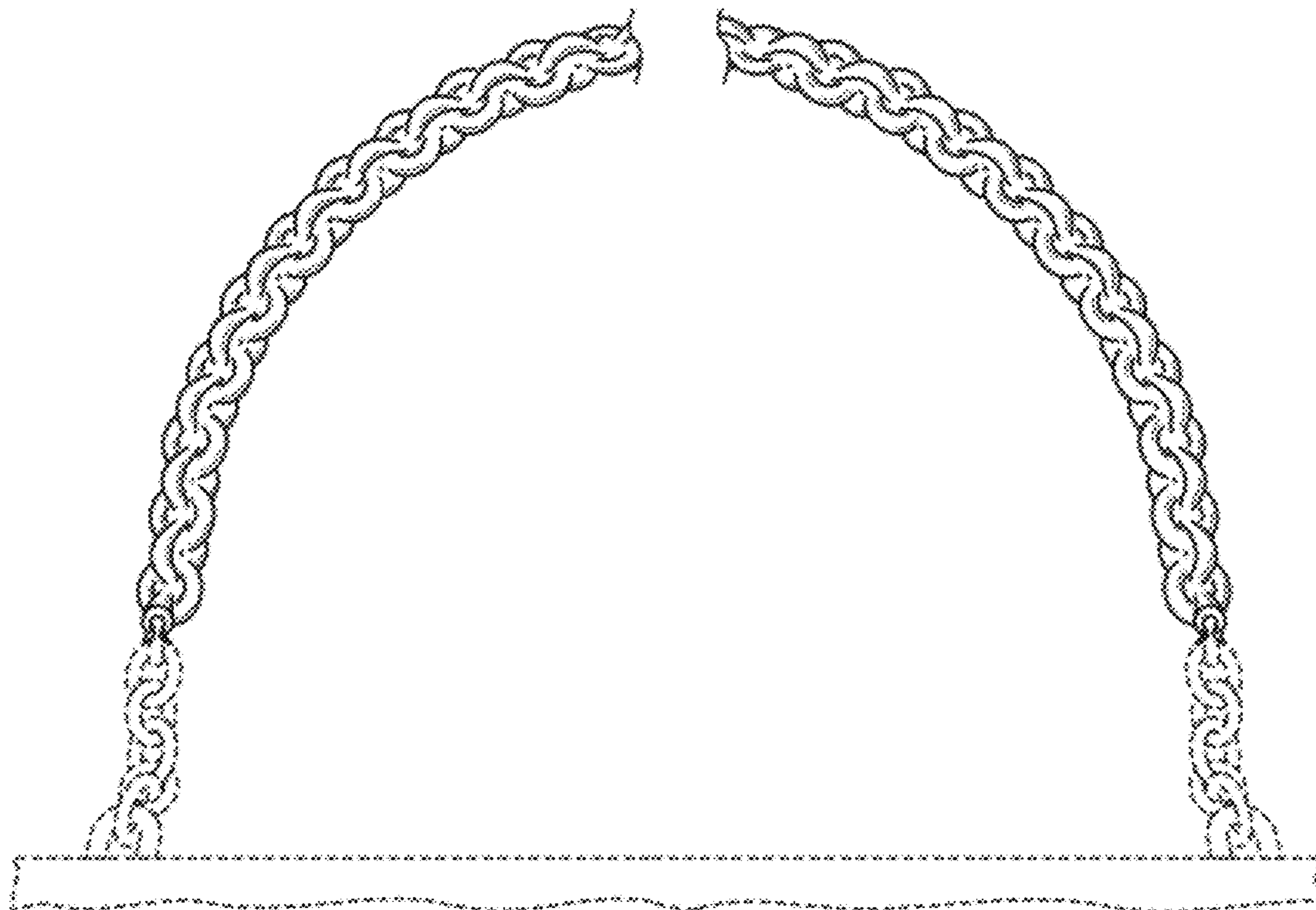

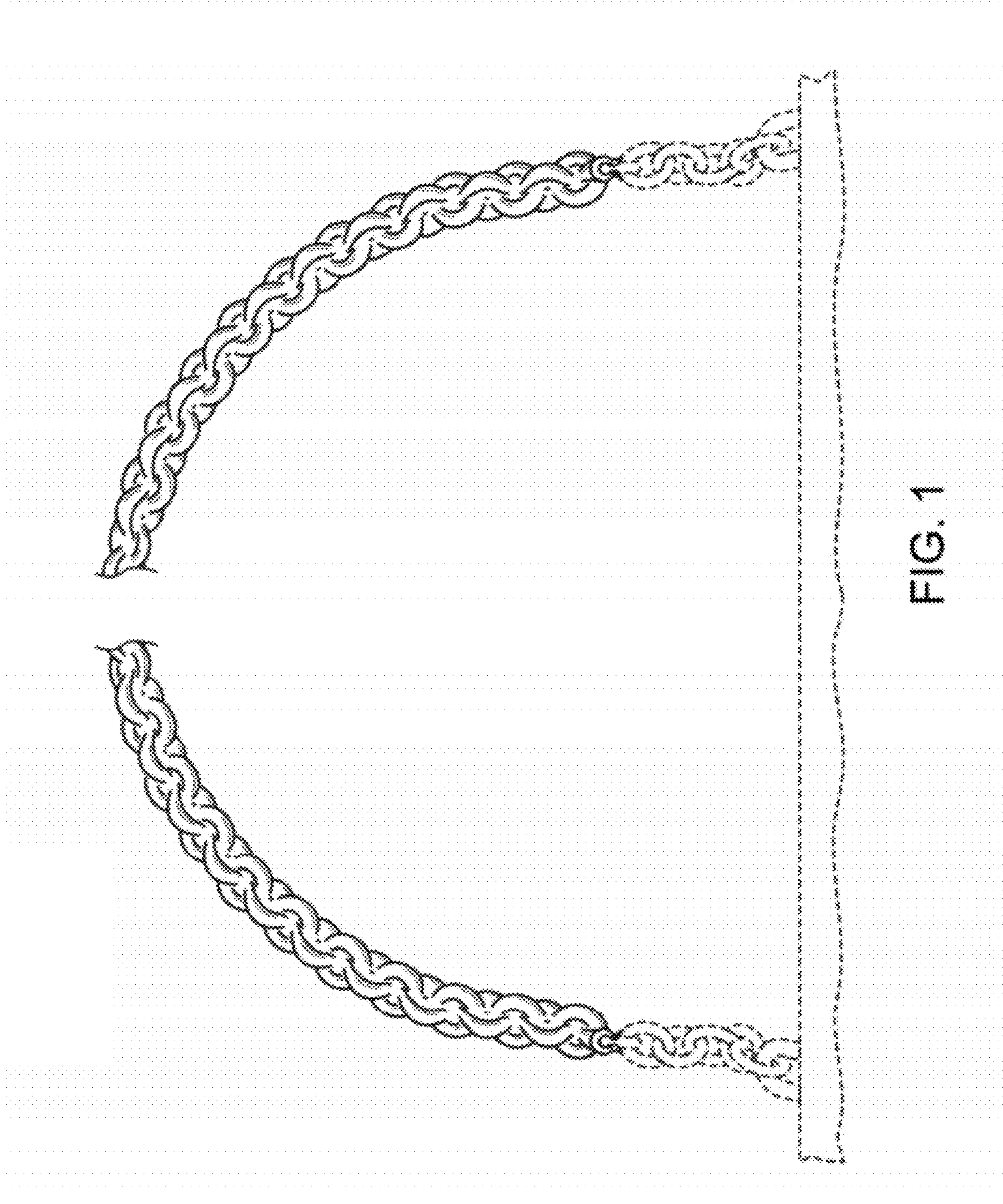

FIG. 1

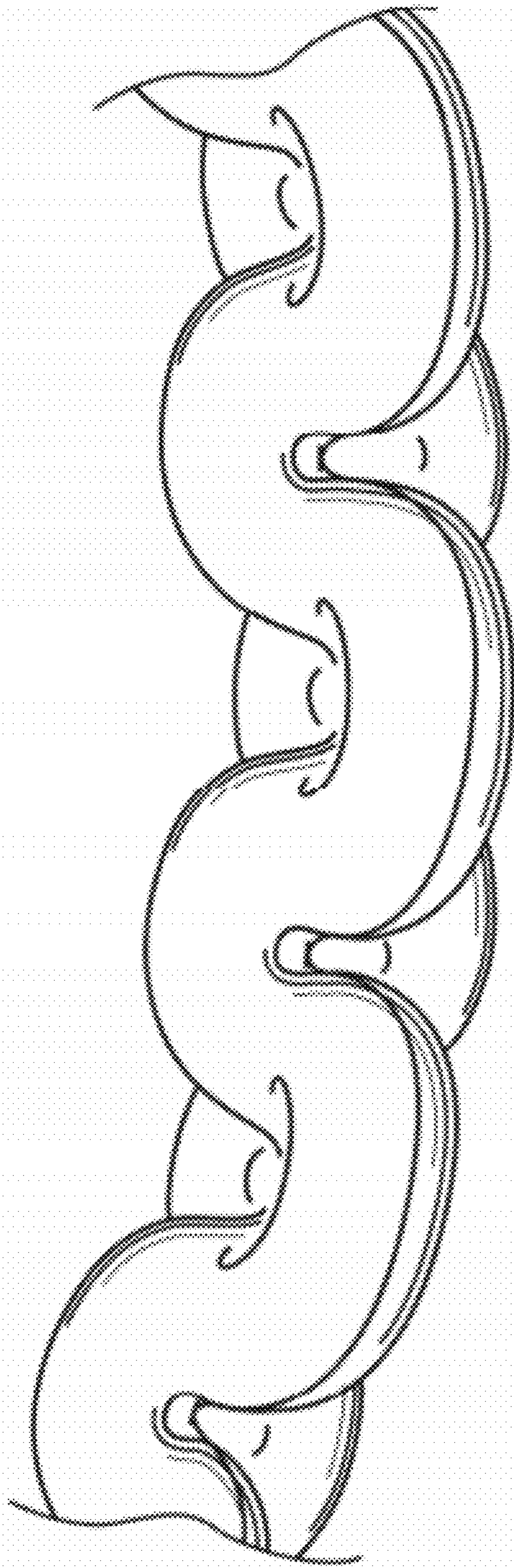

FIG. 2

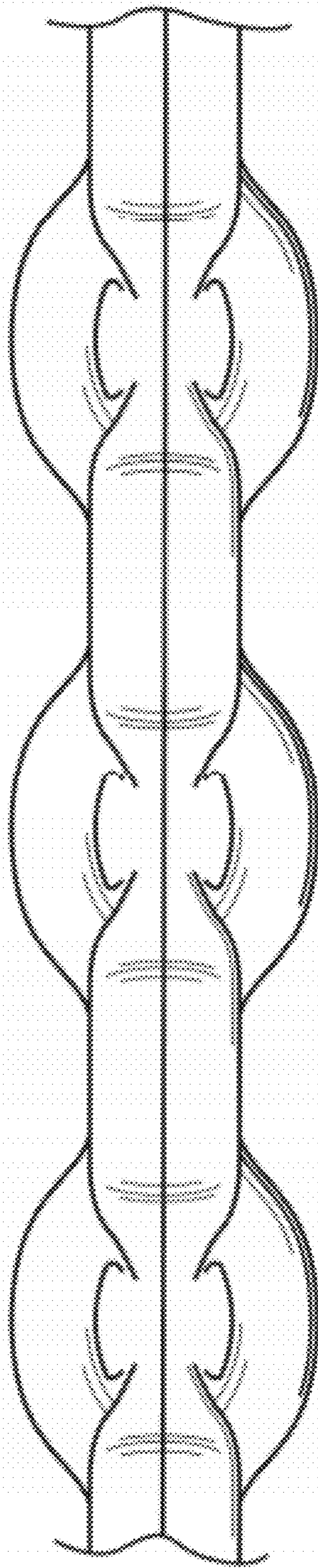

FIG. 3

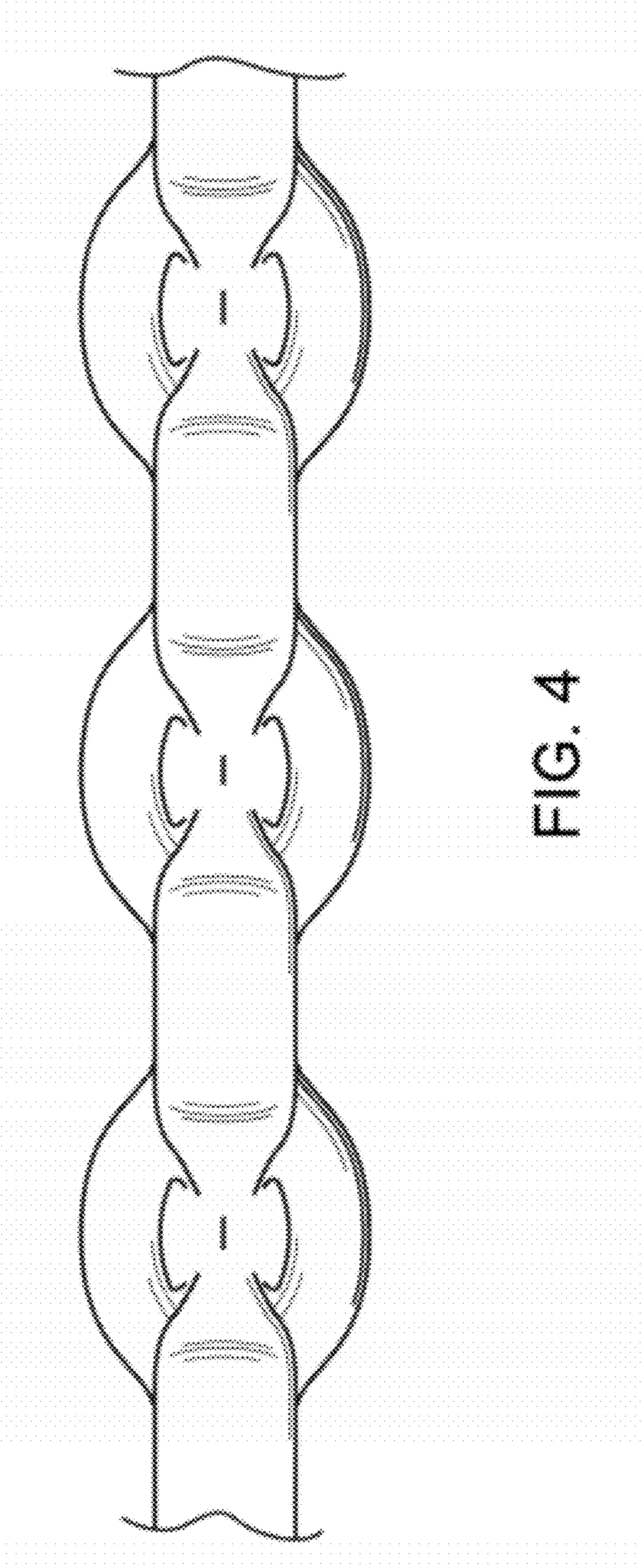

FIG. 4

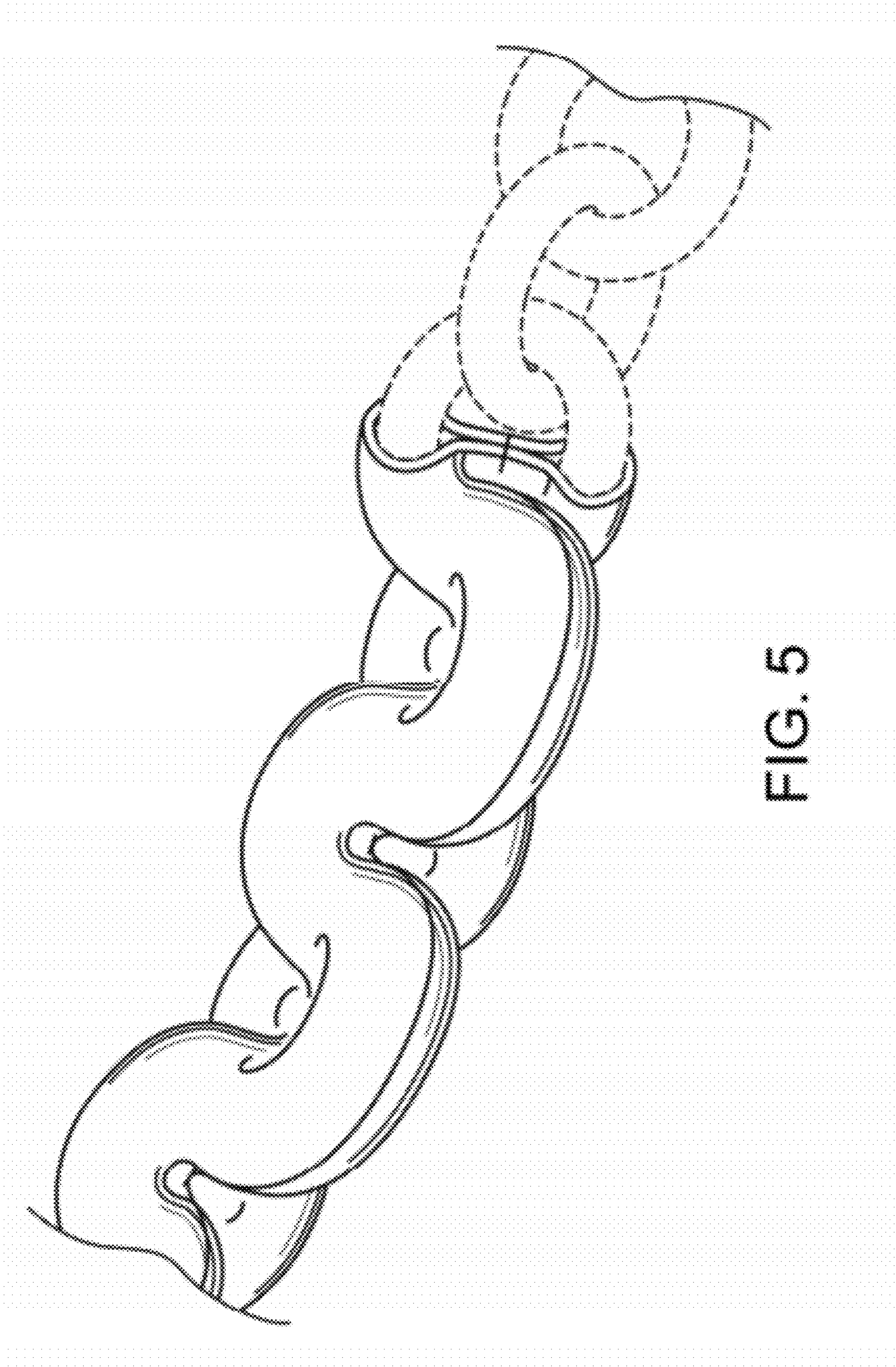

FIG. 5

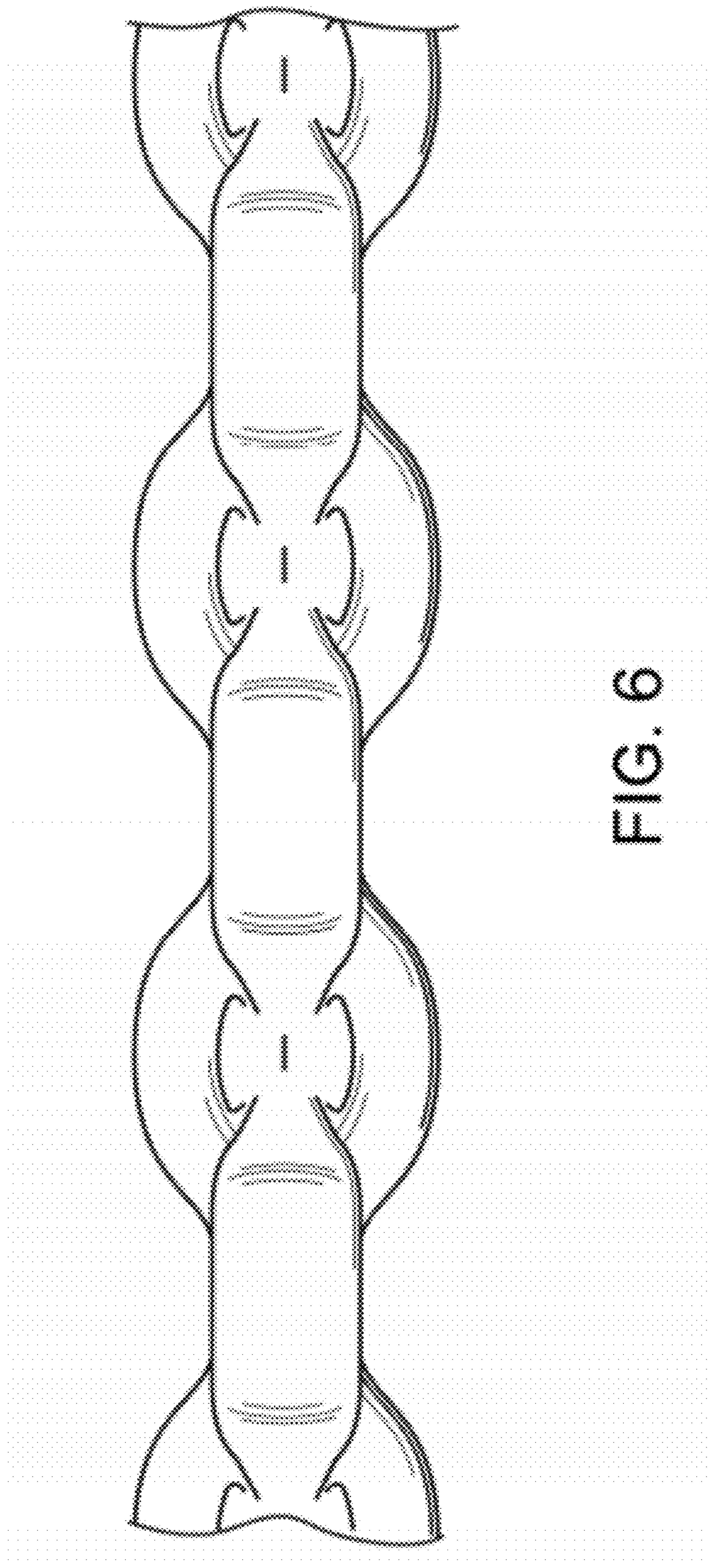

FIG. 6