



US00D677307S

(12) **United States Design Patent**  
**Inoue et al.**

(10) **Patent No.:** **US D677,307 S**  
(45) **Date of Patent:** **\*\* Mar. 5, 2013**

(54) **PROJECTOR**

(75) Inventors: **Kazuya Inoue**, Minato-ku (JP);  
**Toshiyuki Yamaguchi**, Minato-ku (JP);  
**Akira Oda**, Minato-ku (JP); **Takuji**  
**Katsutani**, Ota-ku (JP)

(73) Assignee: **NEC Display Solutions, Ltd.**, Tokyo  
(JP)

(\*\*) Term: **14 Years**

(21) Appl. No.: **29/406,822**

(22) Filed: **Nov. 18, 2011**

(30) **Foreign Application Priority Data**

May 19, 2011 (JP) ..... 2011-11289

(51) **LOC (9) Cl.** ..... **16-02**

(52) **U.S. Cl.** ..... **D16/235; D16/230**

(58) **Field of Classification Search** ..... D16/205,  
D16/208, 219, 221, 225, 230–231, 234–235;  
D21/514; 352/34, 242; 353/100–101, 115,  
353/119, 122; 396/448

See application file for complete search history.

(56) **References Cited**

U.S. PATENT DOCUMENTS

D497,929	S	*	11/2004	Ohki et al.	.....	D16/230
D545,342	S	*	6/2007	Sakamaki et al.	.....	D16/235
D548,264	S	*	8/2007	Sakamaki et al.	.....	D16/230
D595,329	S	*	6/2009	Sakamaki et al.	.....	D16/235
7,677,739	B2	*	3/2010	Kuroda	.....	353/119
D647,555	S	*	10/2011	Ogawa et al.	.....	D16/235
D656,174	S	*	3/2012	Ogawa et al.	.....	D16/230

\* cited by examiner

*Primary Examiner* — Wan Laymon

(74) *Attorney, Agent, or Firm* — Sughrue Mion, PLLC

(57) **CLAIM**

The ornamental design for a projector, as shown and described.

**DESCRIPTION**

FIG. 1 is a front, left side, top perspective view of a projector showing our new design;

FIG. 2 is a front elevational view thereof;

FIG. 3 is a rear elevational view thereof;

FIG. 4 is a left side elevational view thereof;

FIG. 5 is a right side elevational view thereof;

FIG. 6 is a slightly enlarged top plan view thereof;

FIG. 7 is a slightly enlarged bottom plan view thereof; and,

FIG. 8 is a front, left side, top perspective view thereof showing a state in which a lens cover is closed.

The broken lines shown in the figures represent portions of the projector that form no part of the claimed design.

**1 Claim, 8 Drawing Sheets**

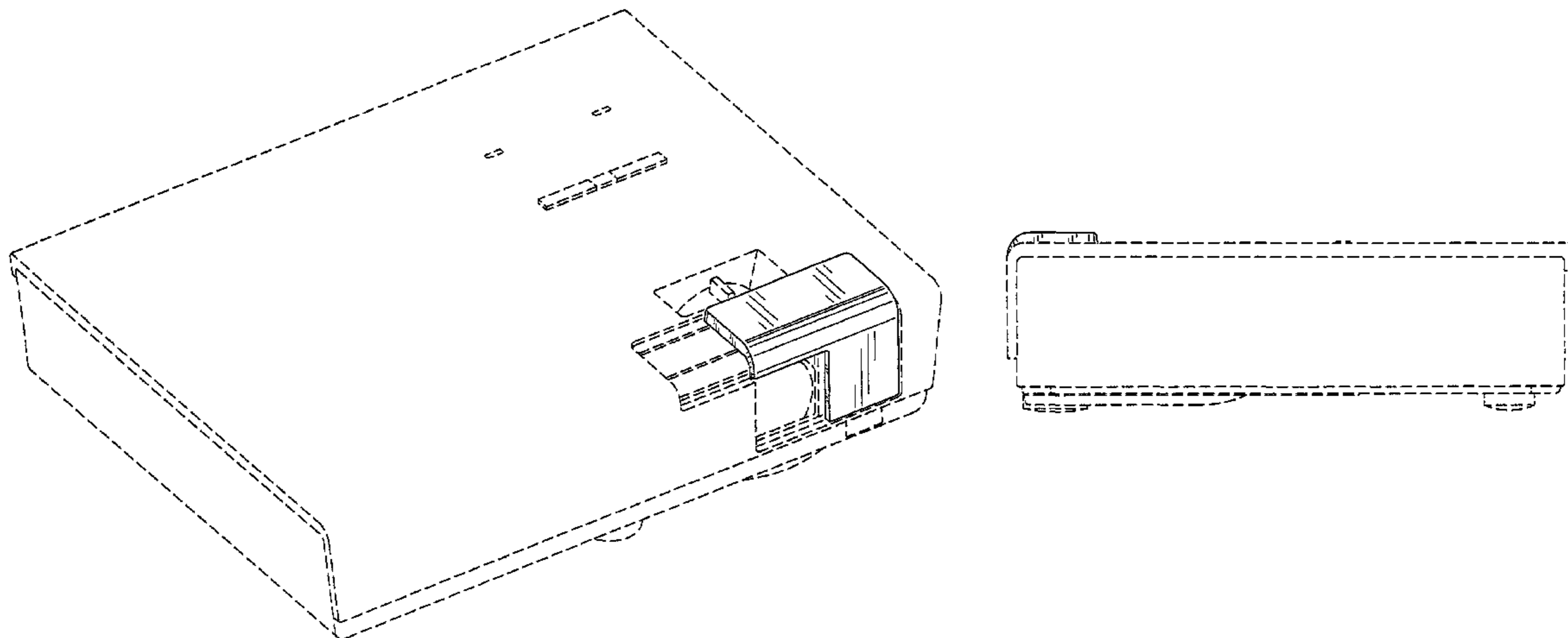

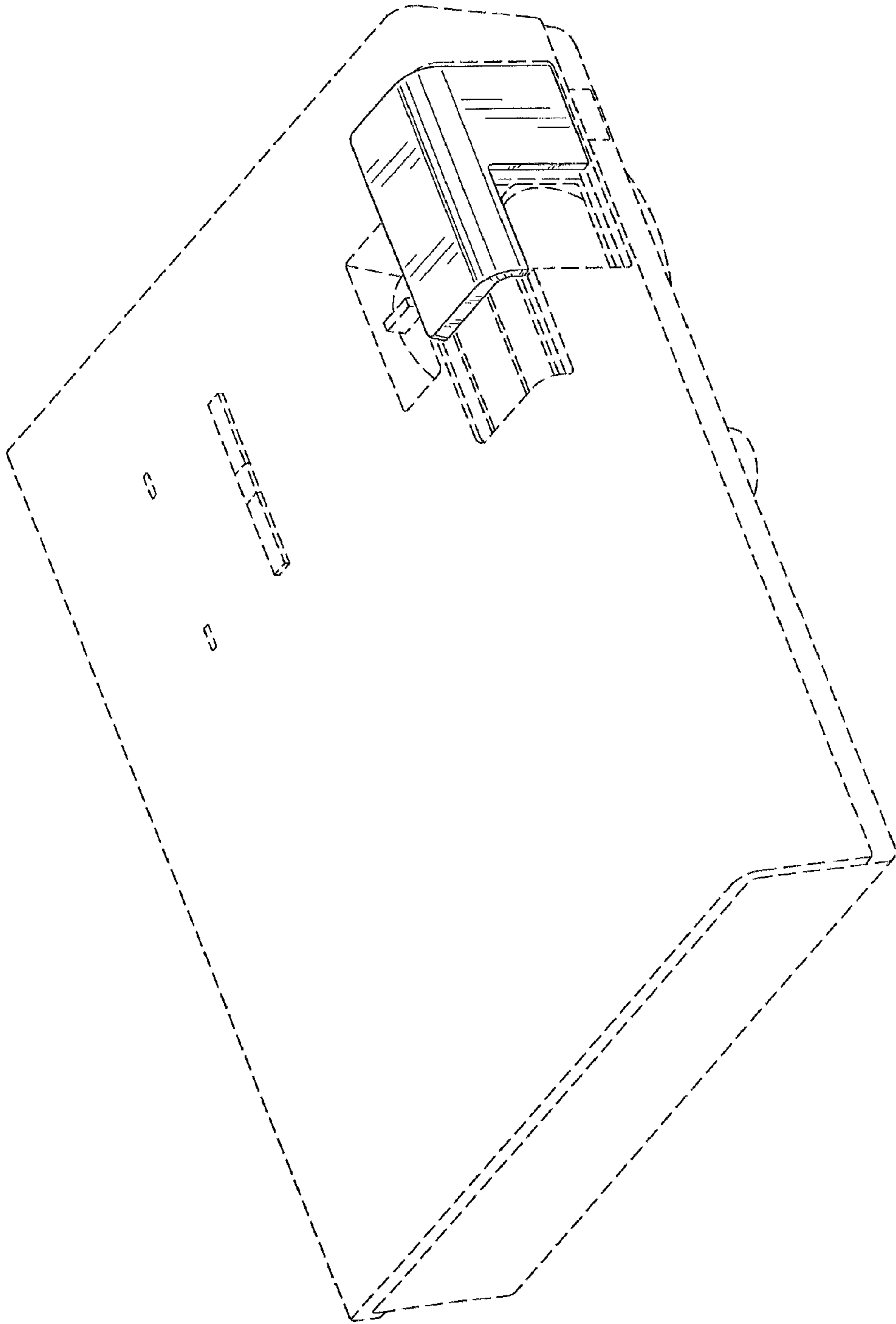

FIG. 1

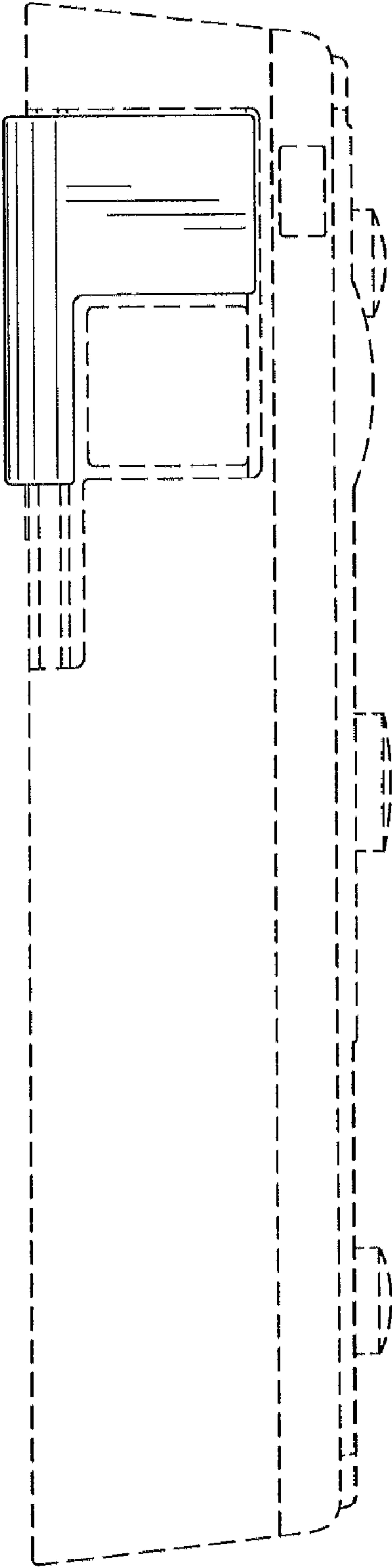

FIG. 2

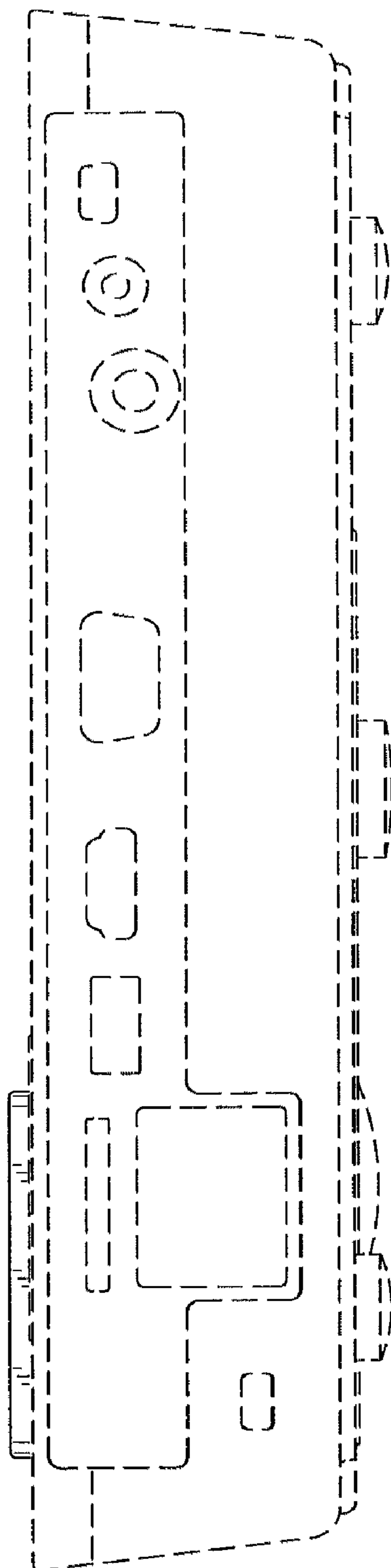

FIG. 3

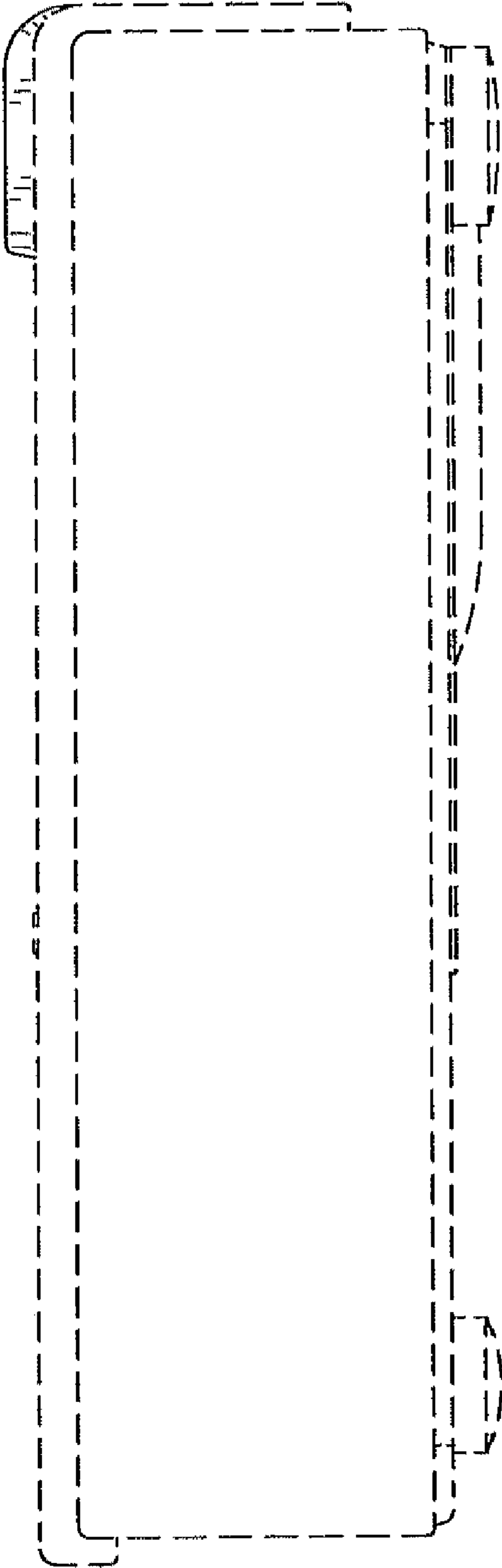

FIG. 4

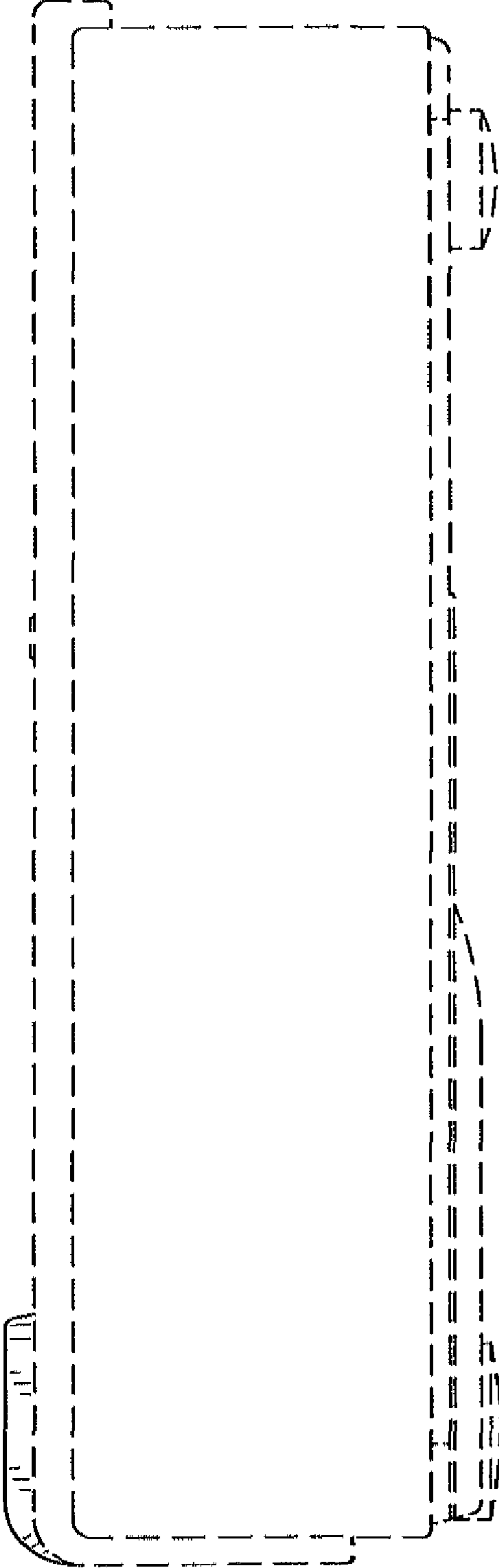

FIG. 5

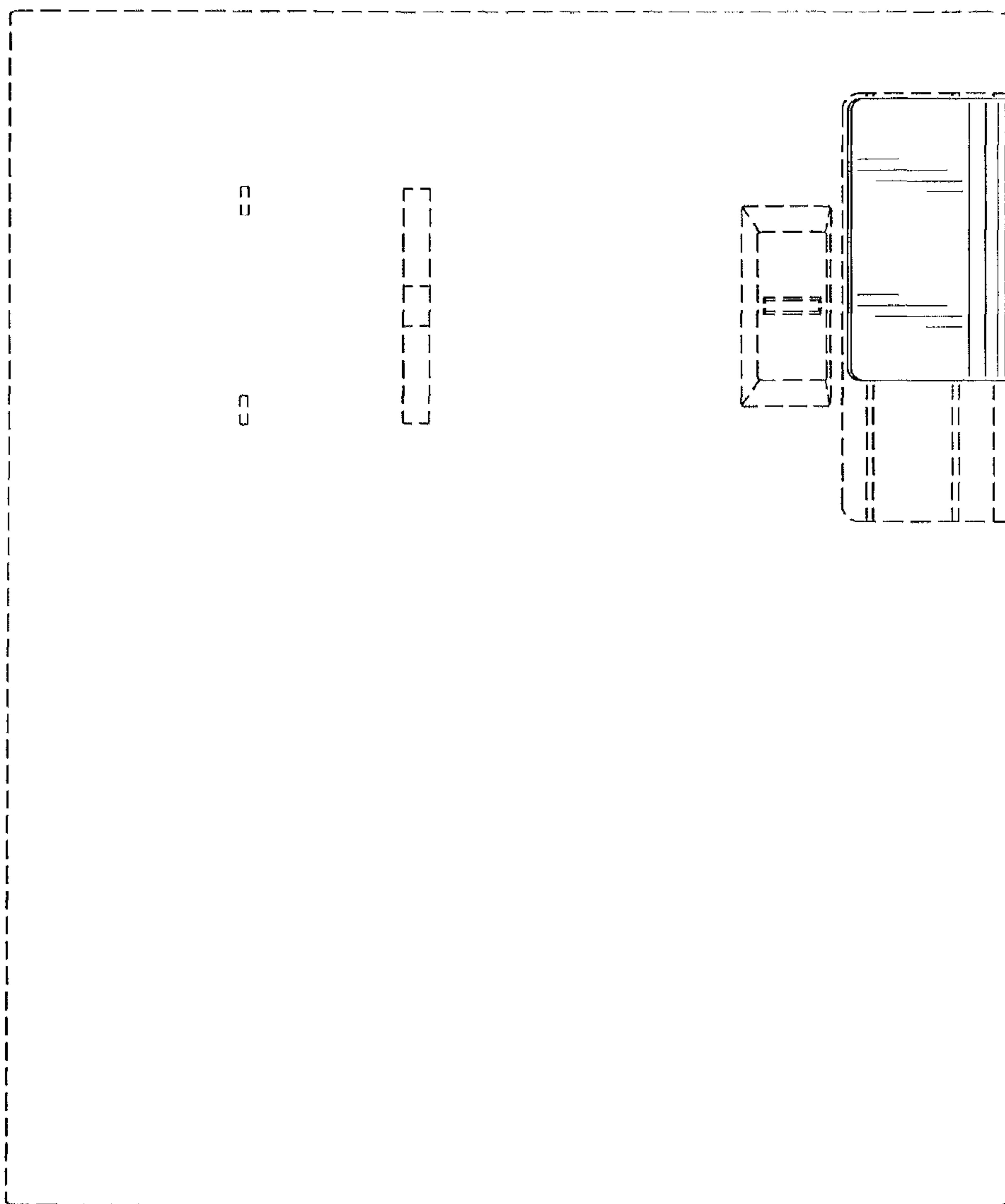

FIG. 6

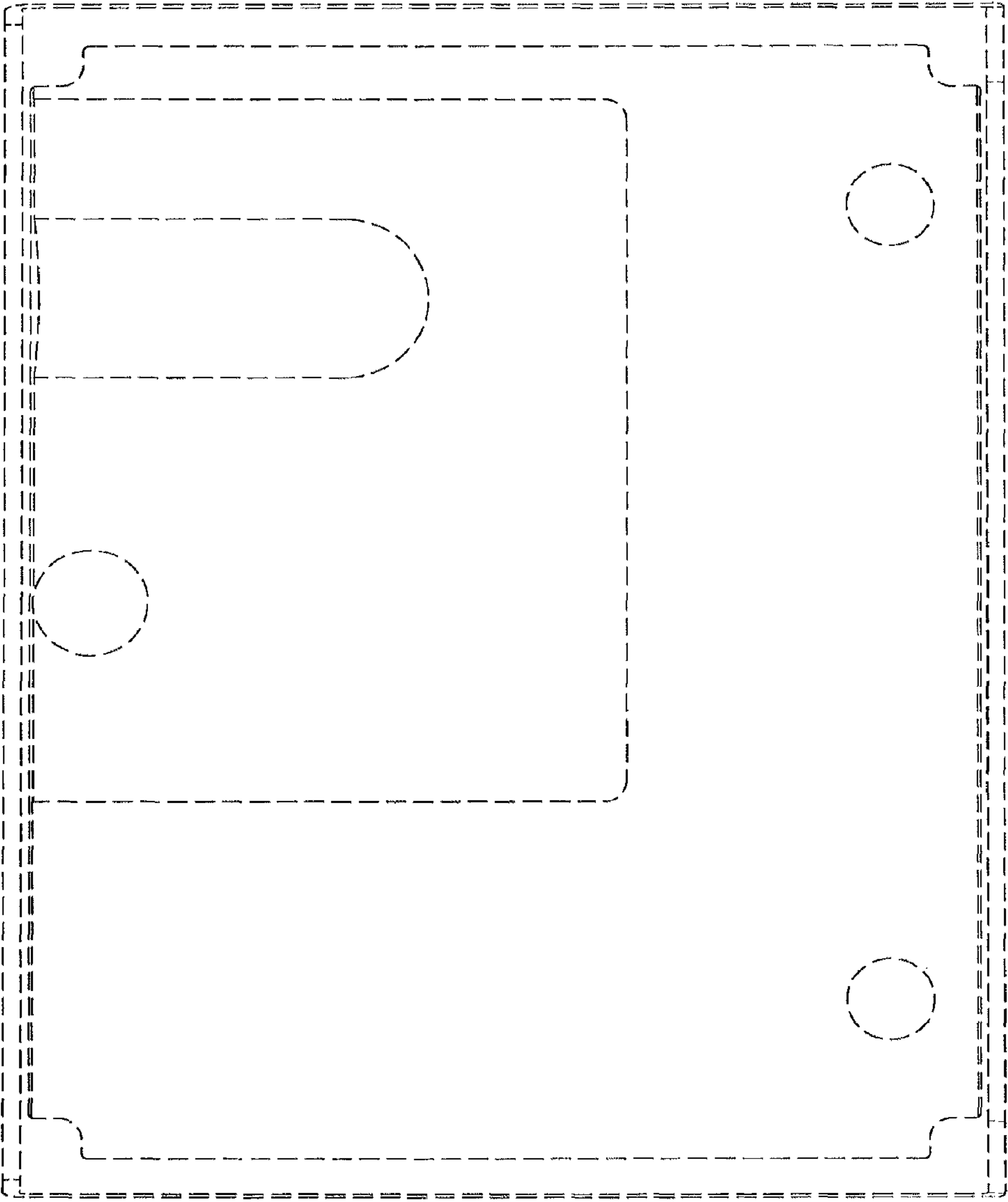

FIG. 7



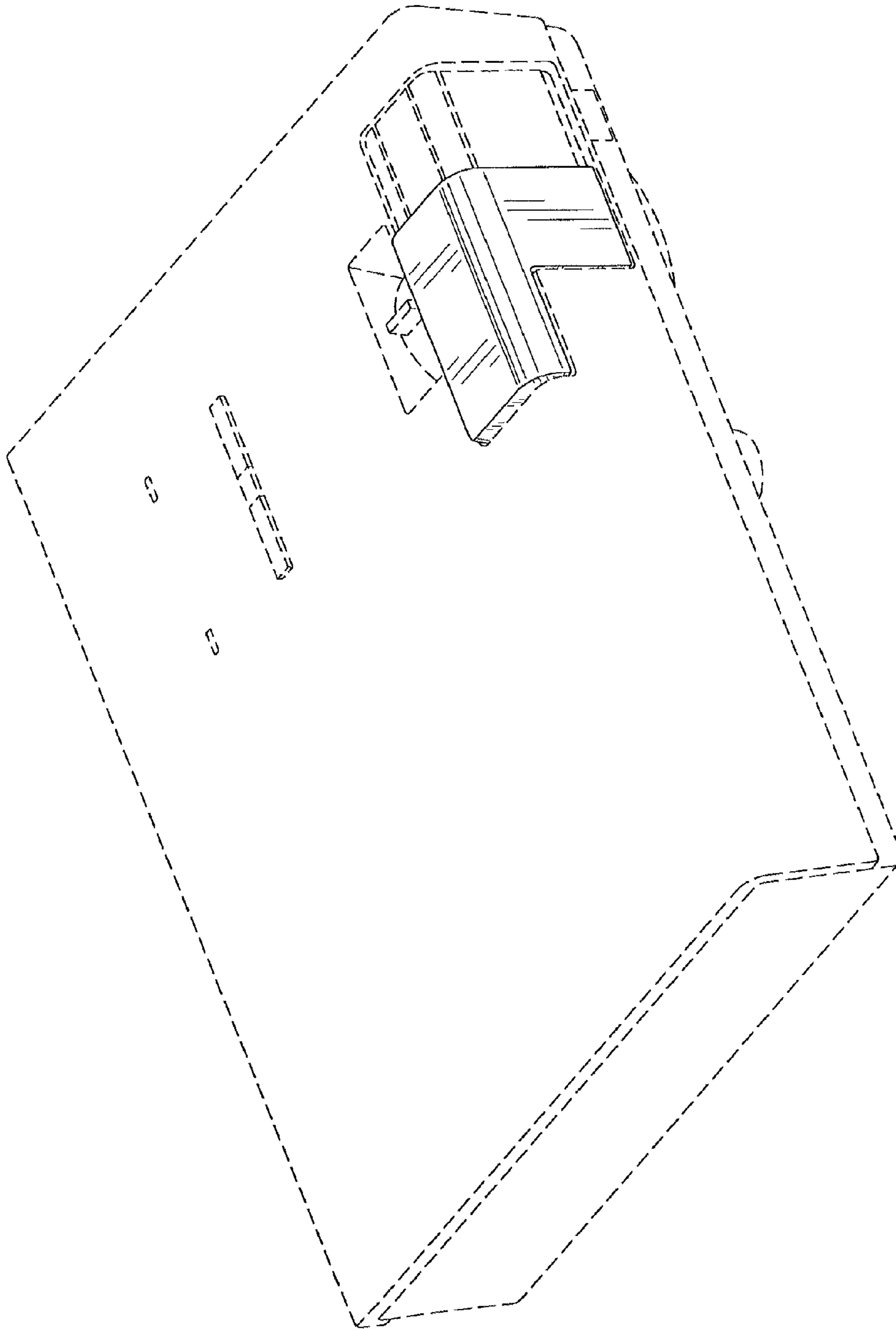

FIG. 8