



US00D677246S

(12) **United States Design Patent**
Furukawa

(10) **Patent No.:** **US D677,246 S**

(45) **Date of Patent:** **** Mar. 5, 2013**

(54) **SPEAKER**

(75) Inventor: **Toshio Furukawa**, Daito (JP)

(73) Assignee: **Funai Electric Co., Ltd.**, Osaka (JP)

(**) Term: **14 Years**

(21) Appl. No.: **29/409,638**

(22) Filed: **Dec. 27, 2011**

(51) **LOC (9) Cl.** **14-03**

(52) **U.S. Cl.** **D14/214**

(58) **Field of Classification Search** D14/172,
D14/194, 196, 204, 207, 210–216; 181/143,
181/144, 147, 148, 150, 153, 157, 198, 199;
381/300–303, 306, 332, 333, 336, 345, 361–364,
381/386–388

See application file for complete search history.

(56) **References Cited**

U.S. PATENT DOCUMENTS

D361,071 S * 8/1995 Mark D14/211
D526,640 S * 8/2006 Chin et al. D14/188

D571,356 S * 6/2008 Smith D14/214
D594,877 S * 6/2009 Iino et al. D14/502
D629,827 S * 12/2010 Morenstein et al. D16/221
D646,665 S * 10/2011 Iijima D14/214
D654,473 S * 2/2012 Paddock D14/214

* cited by examiner

Primary Examiner — Keli L Hill

(74) *Attorney, Agent, or Firm* — Sughrue Mion, PLLC

(57) **CLAIM**

The ornamental design for a speaker, as shown and described.

DESCRIPTION

FIG. 1 is a perspective view of the top, front and right side of a speaker showing my (our) new design;
FIG. 2 is a front view thereof;
FIG. 3 is a rear view thereof;
FIG. 4 is a left side view thereof;
FIG. 5 is a right view thereof; and,
FIG. 6 is a top plan view thereof.

1 Claim, 7 Drawing Sheets

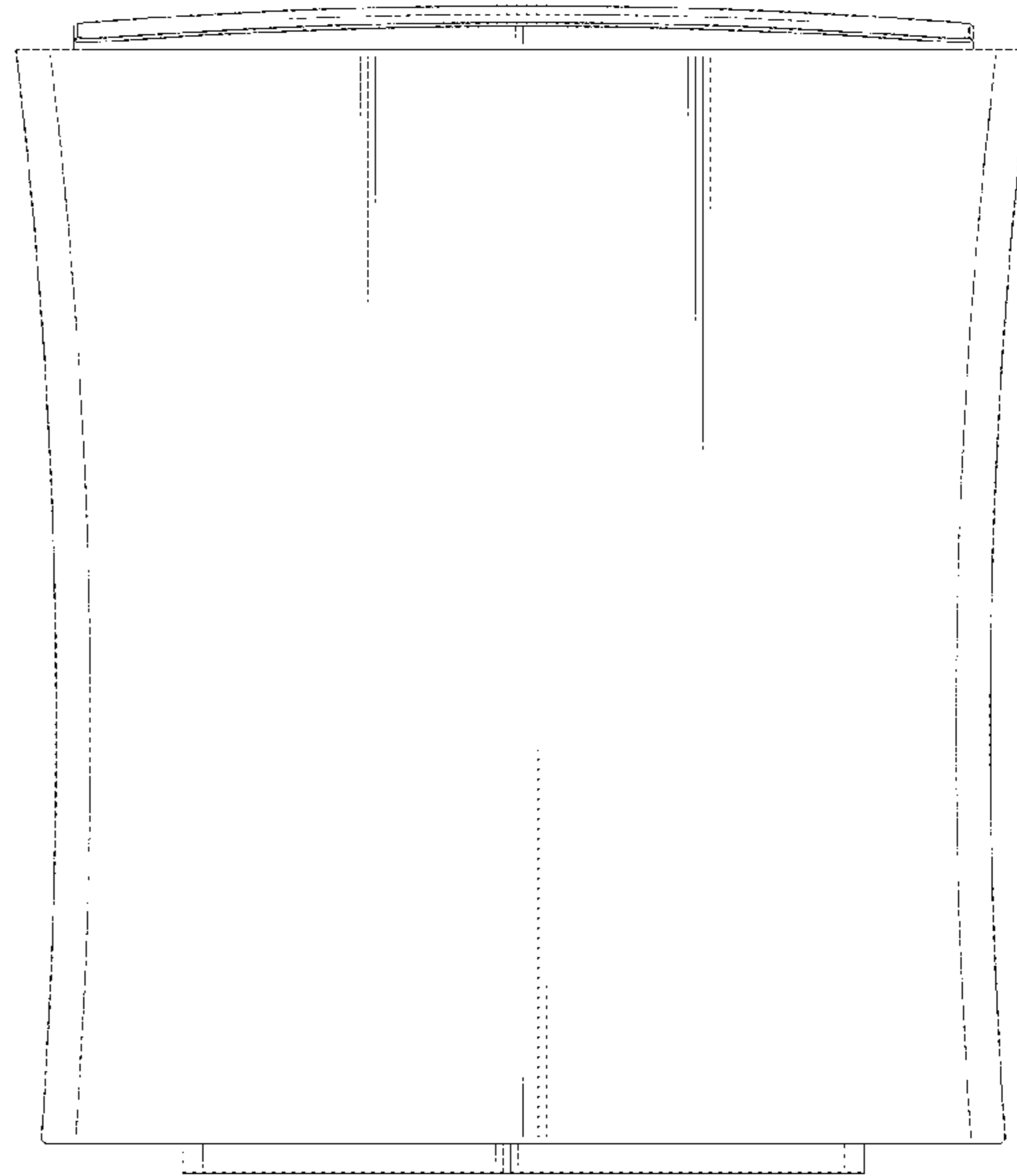
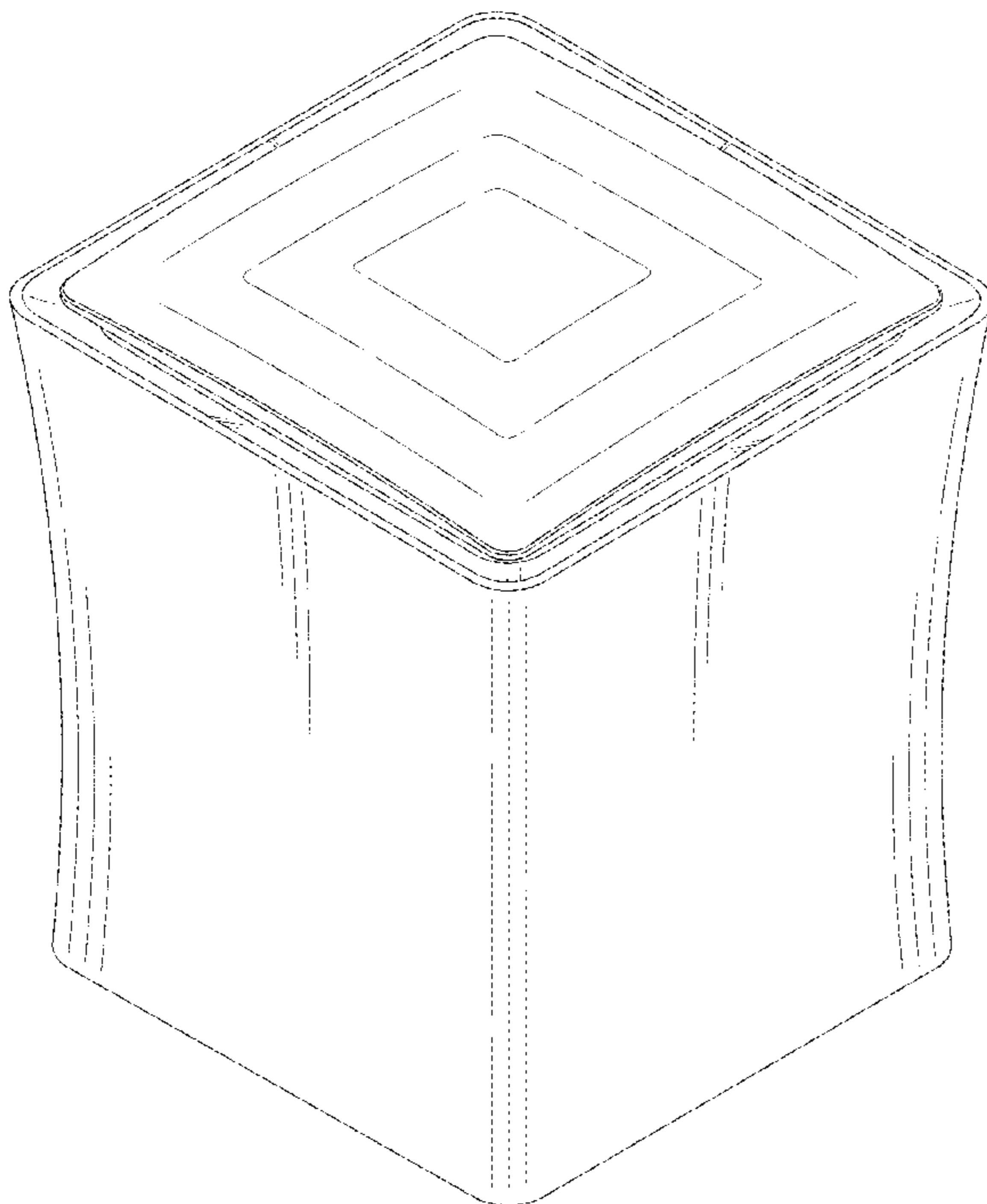

Fig. 1

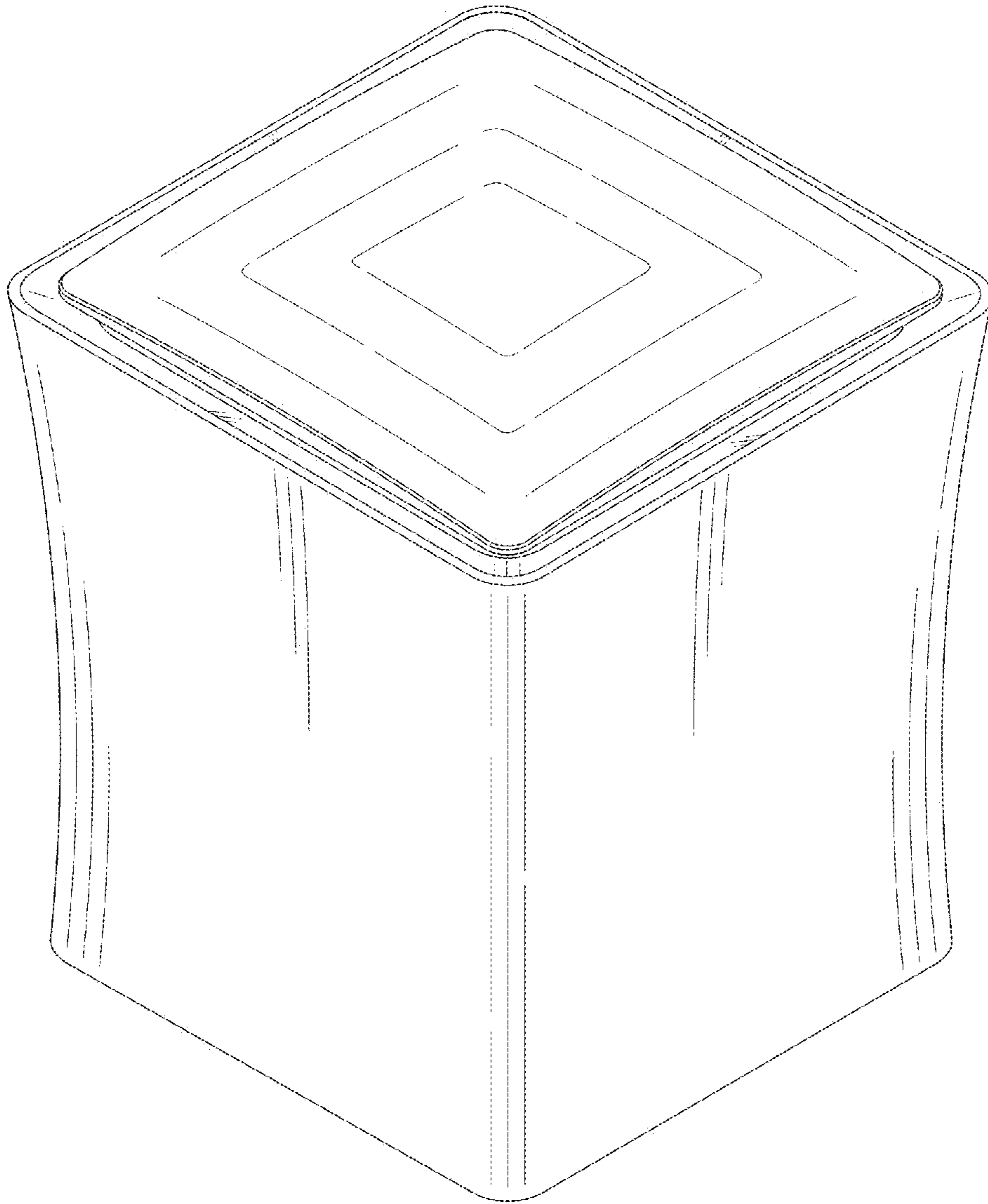

Fig. 2

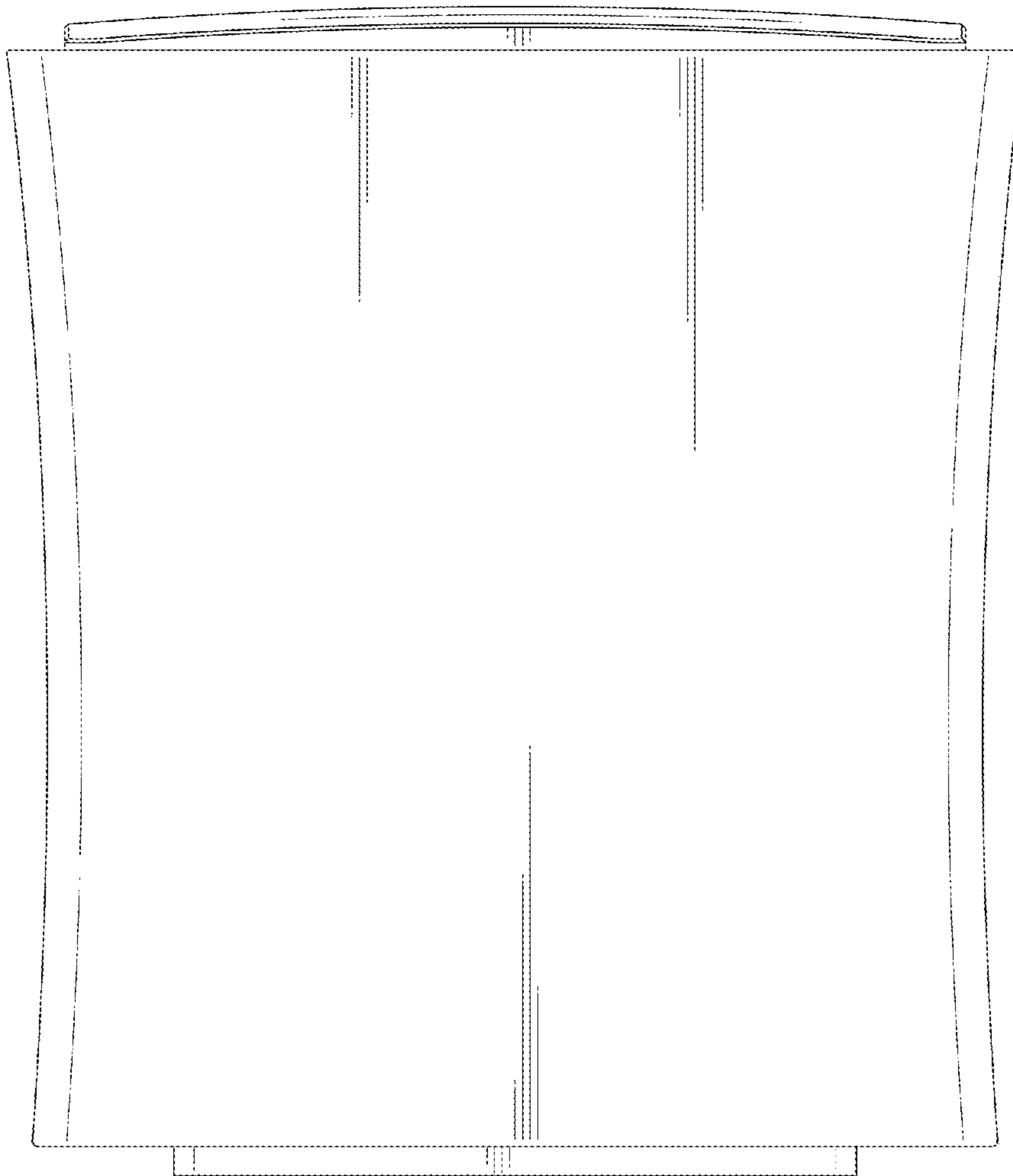

Fig. 3

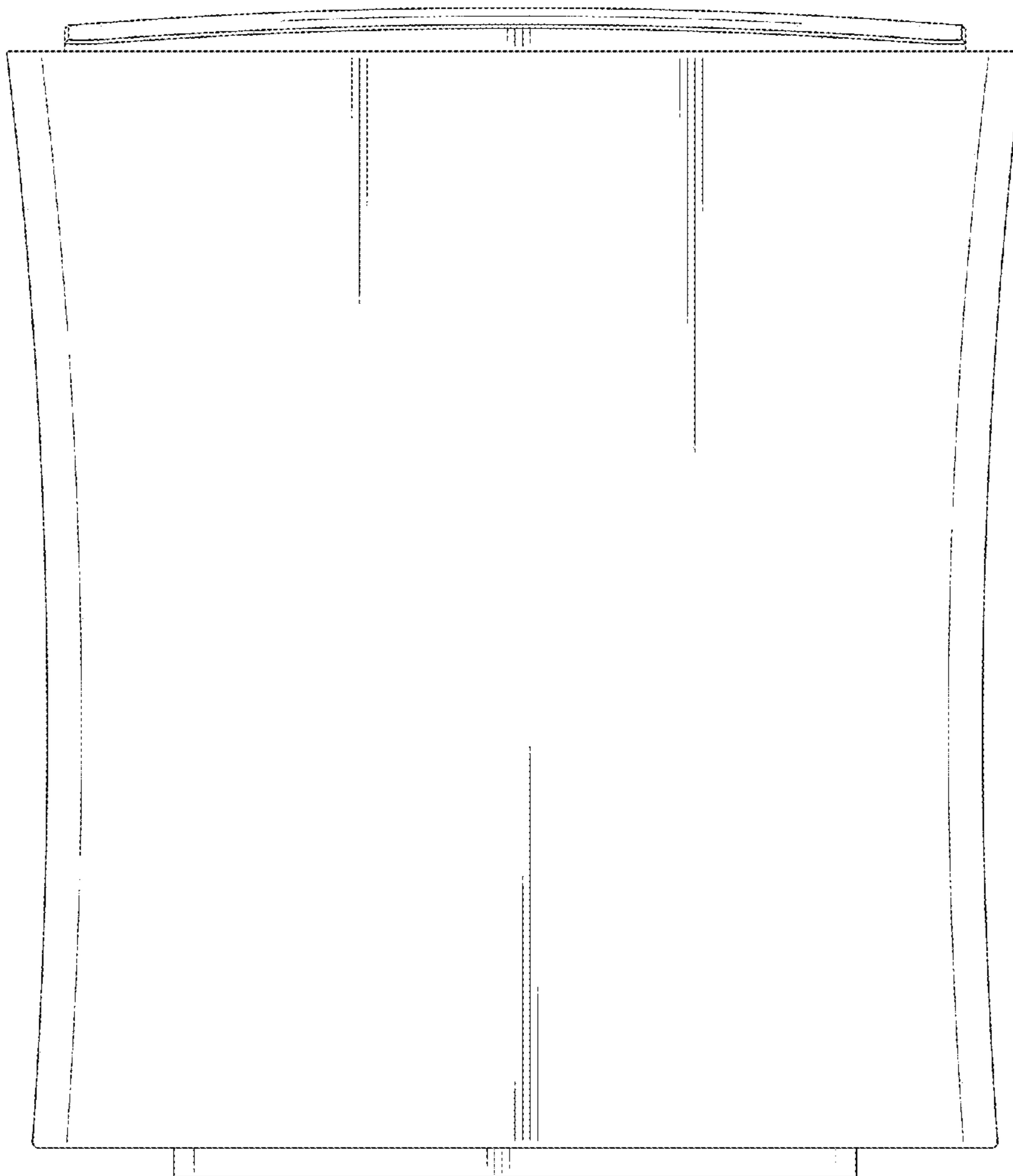

Fig. 4

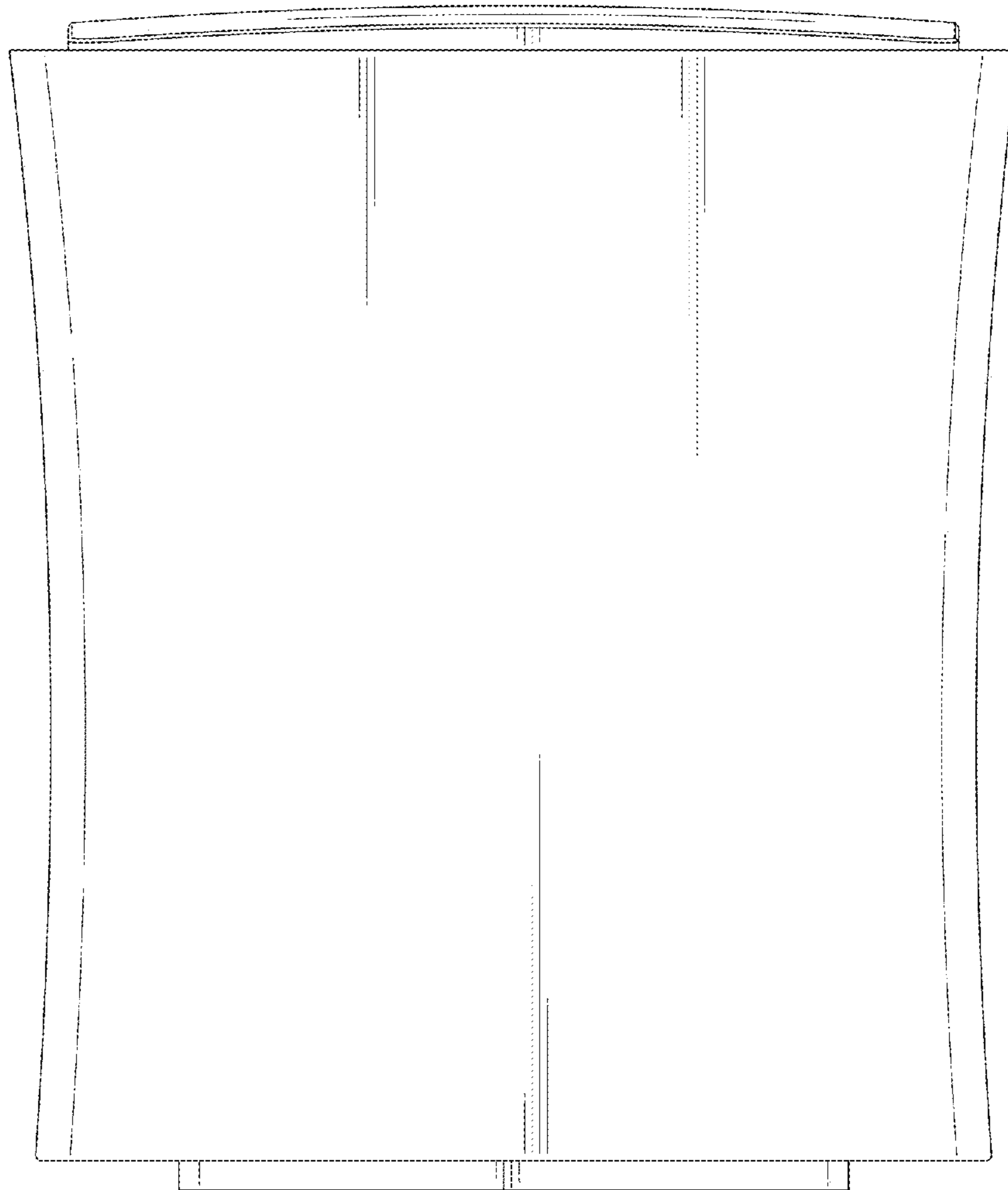

Fig. 5

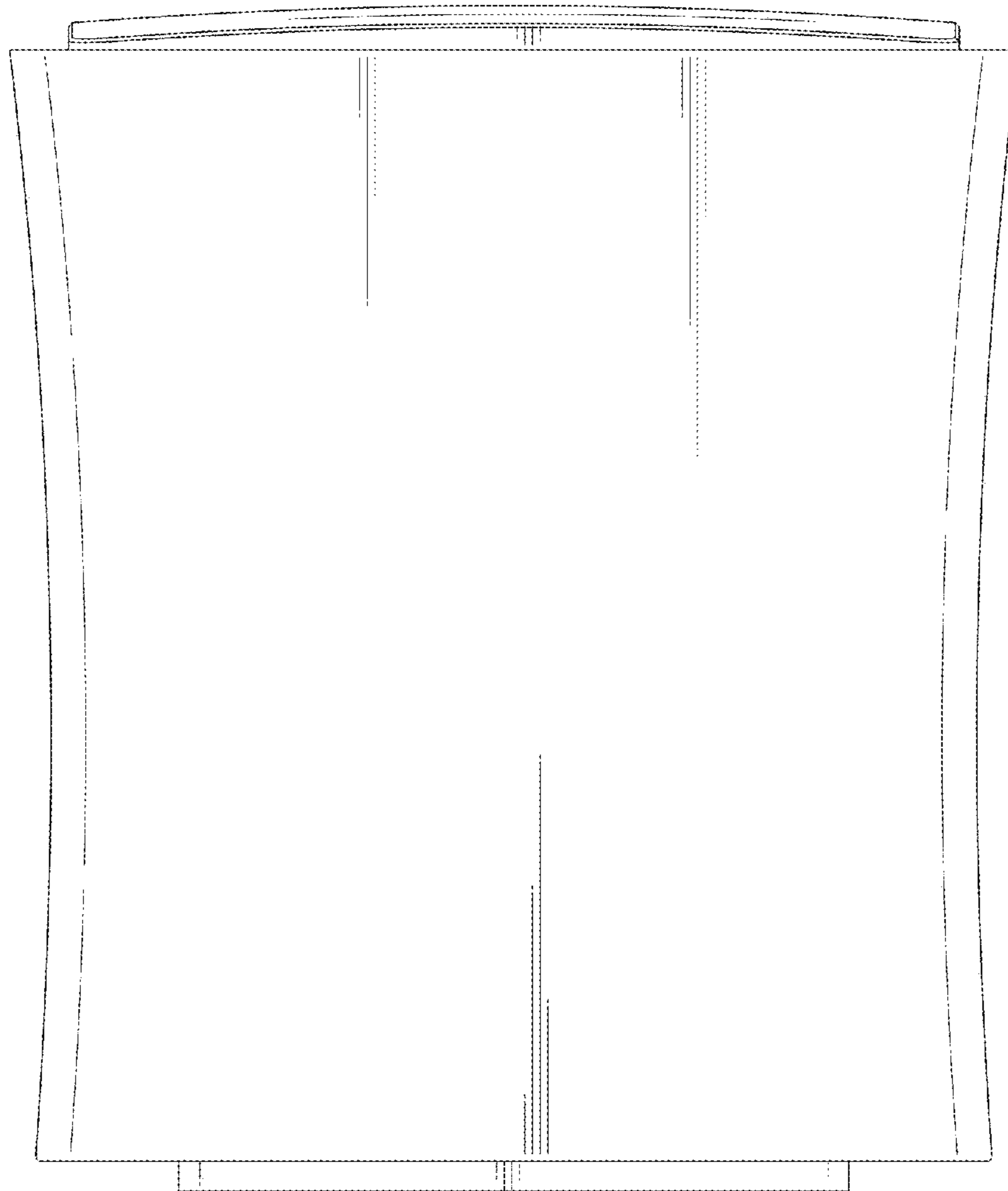

Fig. 6

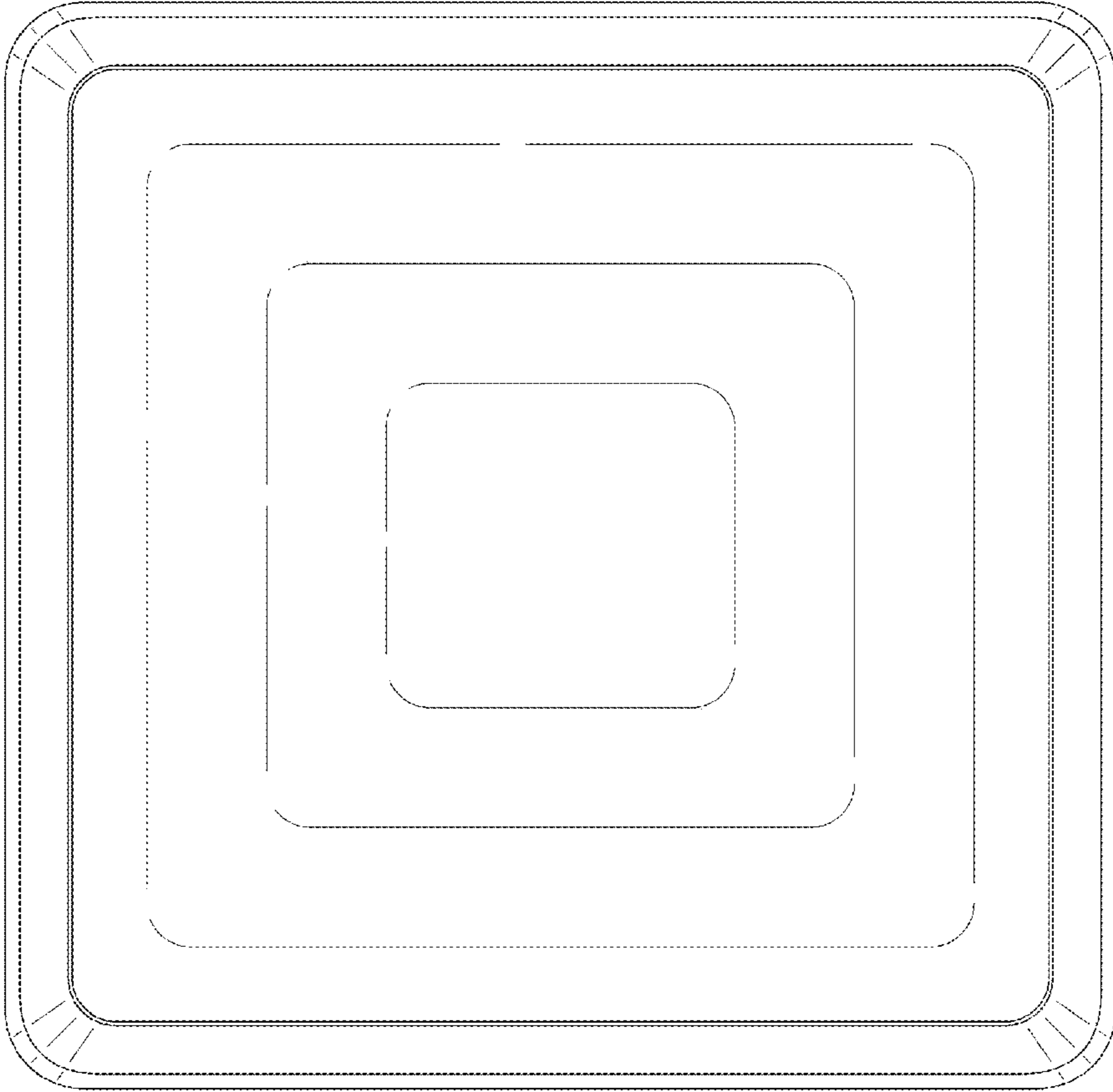

Fig. 7

