



US00D677238S

(12) **United States Design Patent**
Shioya

(10) **Patent No.:** **US D677,238 S**
(45) **Date of Patent:** **** Mar. 5, 2013**

(54) **TELEPHONE HANDSET**

(75) Inventor: **Kenji Shioya**, Fukuoka (JP)

(73) Assignee: **Panasonic Corporation**, Osaka (JP)

(**) Term: **14 Years**

(21) Appl. No.: **29/427,634**

(22) Filed: **Jul. 20, 2012**

(30) **Foreign Application Priority Data**

May 7, 2012 (CN) 2012 3 0154282

(51) **LOC (9) Cl.** **14-03**

(52) **U.S. Cl.** **D14/147; D14/138 AA**

(58) **Field of Classification Search** D14/138 G,
D14/138 AD, 341, 346, 138 R, 138 AA, 496,
D14/203.1, 203.4, 203.7, 248, 218, 147, 148;
455/575.1, 556.2, 575.3, 575.4; D21/517;
379/433.01, 433.04, 433.12, 433.13; D10/65,
D10/78, 104; D13/168

See application file for complete search history.

(56) **References Cited**

U.S. PATENT DOCUMENTS

- 6,674,996 B1 * 1/2004 Weckström 455/90.3
- D531,137 S * 10/2006 Wu D13/168
- D541,786 S * 5/2007 Ookawa D14/147
- D542,765 S * 5/2007 Cho et al. D14/138 AA
- D583,349 S * 12/2008 Lee et al. D14/138 AA
- D583,354 S 12/2008 Gonser et al.
- D584,279 S * 1/2009 Yoshie et al. D14/138 AA
- D586,326 S 2/2009 Hwang
- D589,922 S * 4/2009 Boyd et al. D14/138 AA
- D611,442 S * 3/2010 Kim et al. D14/138 AA
- D615,957 S * 5/2010 Ju et al. D14/147
- D617,298 S * 6/2010 Kim et al. D14/138 AA
- D618,202 S * 6/2010 Chaumont et al. D14/138 AA
- D618,657 S * 6/2010 Sakamoto D14/147
- D618,658 S * 6/2010 Sakamoto et al. D14/147
- D619,980 S * 7/2010 Kang D14/138 AA
- D620,915 S * 8/2010 Brabander D14/147
- D628,186 S 11/2010 Yang
- D633,089 S * 2/2011 Hsu D14/341
- D637,986 S * 5/2011 Sheu D14/138 AA

- D638,393 S * 5/2011 Gonser et al. D14/147
- D641,334 S * 7/2011 Hong et al. D14/138 AA
- D644,198 S * 8/2011 Brabander D14/147
- D647,516 S * 10/2011 Brabander D14/248
- D668,630 S * 10/2012 Sakamoto D14/147
- D671,517 S * 11/2012 Katori D14/148

OTHER PUBLICATIONS

Ruggedized 1.9Ghz DECT Multi-Cell Wireless System Telephone, no posted date given, [online], [site visited Dec. 17, 2012]. Available from Internet, <URL: <http://www.panasonic.com/business/psna/products-home-business/business-phones/phones/multi/KX-TD7696.aspx>>.*

Link Your Cell Phone to Your Home Phone, Dect 6.0 Plus Cordless Answering System, no. posted date given, [online], [site visited Dec. 13, 2012]. Available from Internet, <URL: <http://shop.panasonic.com/shop/telephones/bluetooth-powered-link-to-cell>>.*

Samsung E1070 telephone, announced Feb. 2009, [online], [site visited Dec. 13, 2012]. Available from Internet, <URL: http://www.gsmarena.com/samsung_e1070-2672.php>.*

Motorola W177 telephone, announced Apr. 2008, [online], [site visited Dec. 13, 2012]. Available from Internet, <URL: http://www.gsmarena.com/motorola_w177-2449.php>.*

Primary Examiner — Jeffrey D Asch

(74) *Attorney, Agent, or Firm* — Panasonic Patent Center

(57) **CLAIM**

I claim the ornamental design for a telephone handset, as shown and described.

DESCRIPTION

FIG. 1 is a front perspective view of a telephone handset of the present invention;

FIG. 2 is a rear perspective view thereof;

FIG. 3 is a front view thereof;

FIG. 4 is a first side view thereof;

FIG. 5 is a second side view thereof;

FIG. 6 is a top view thereof;

FIG. 7 is a rear view thereof; and,

FIG. 8 is a bottom view thereof.

The broken line showing of telephone handset is included for the purpose of illustrating environment and forms no part of the claimed design. Additionally, the unevenly broken lines in the drawings define the limits of the claimed design.

1 Claim, 8 Drawing Sheets

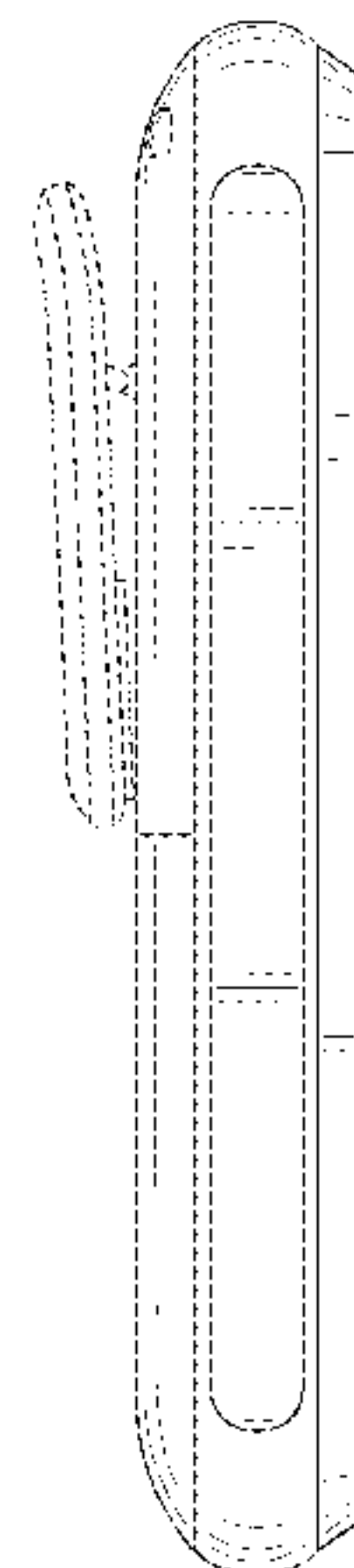
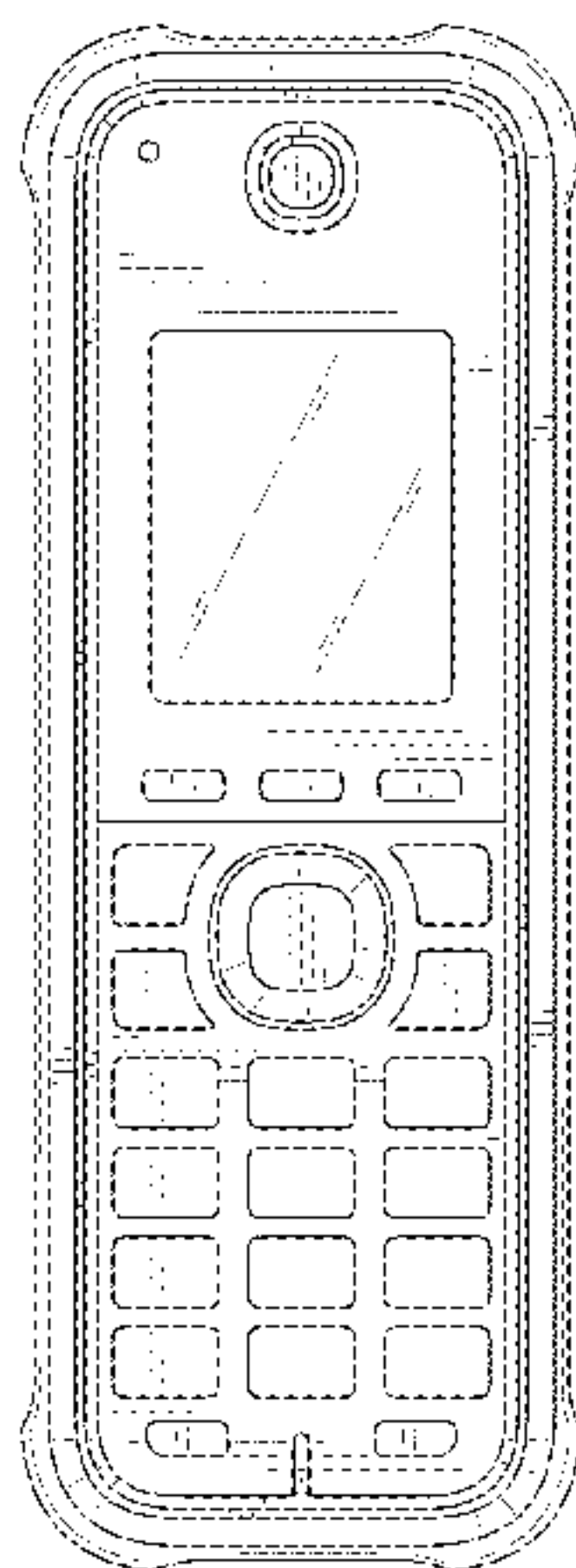

FIG. 1

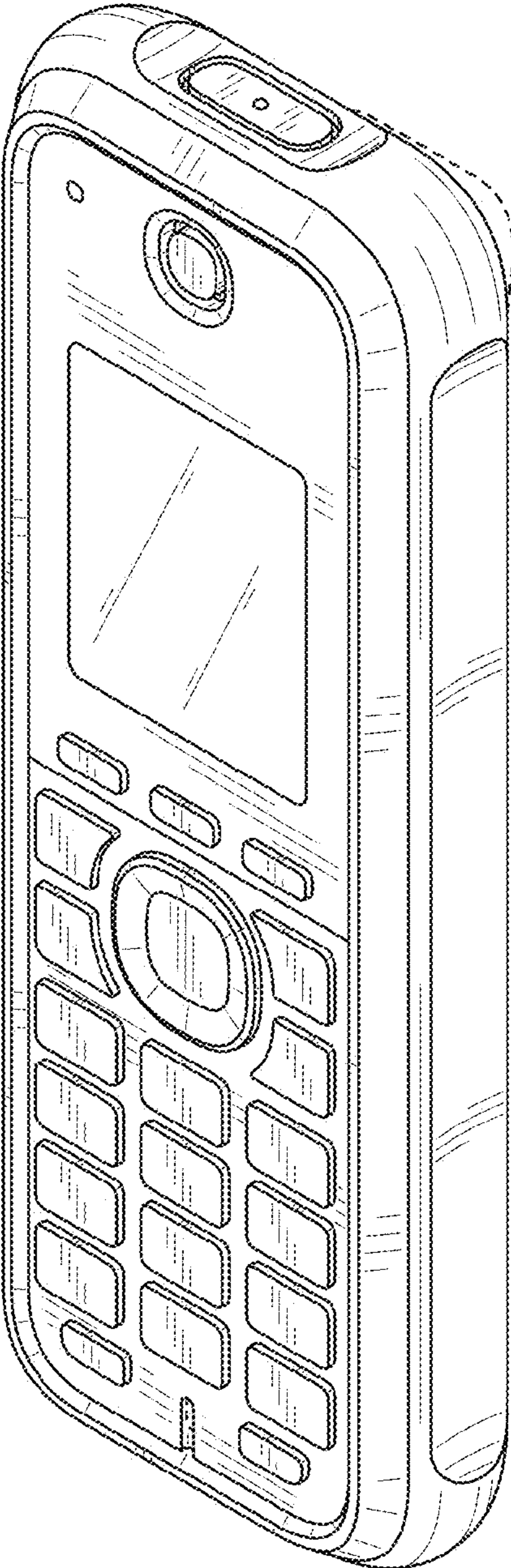

FIG. 2

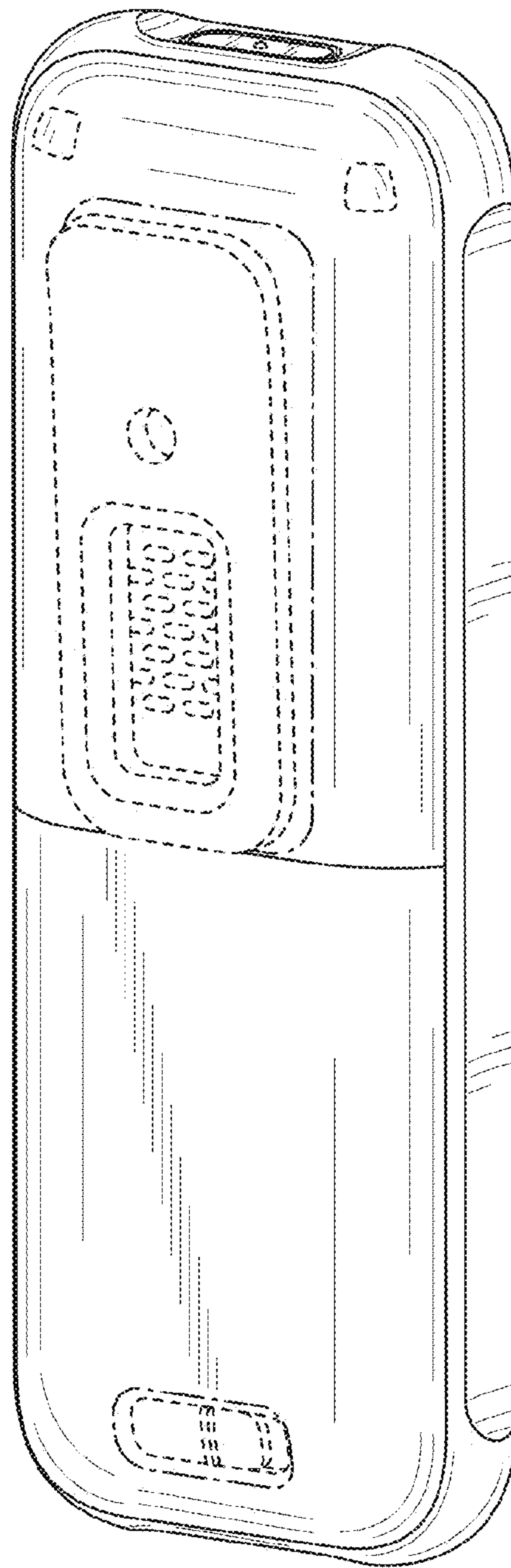

FIG. 3

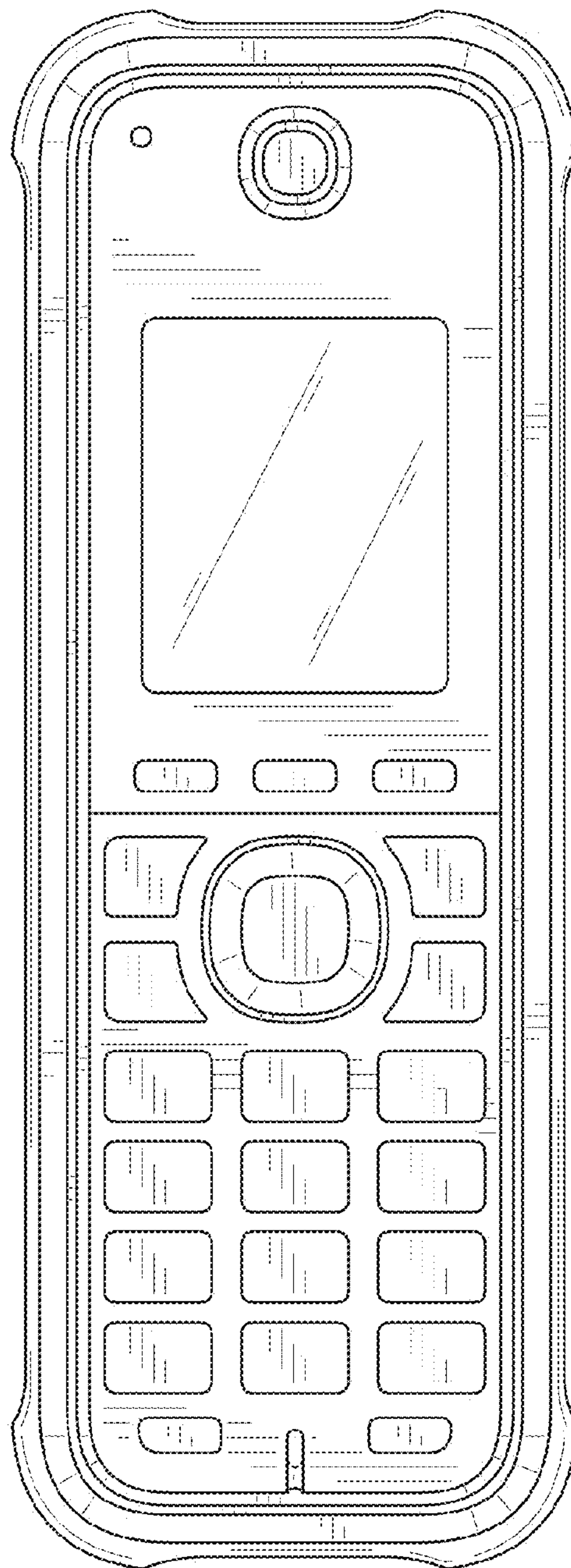

FIG. 4

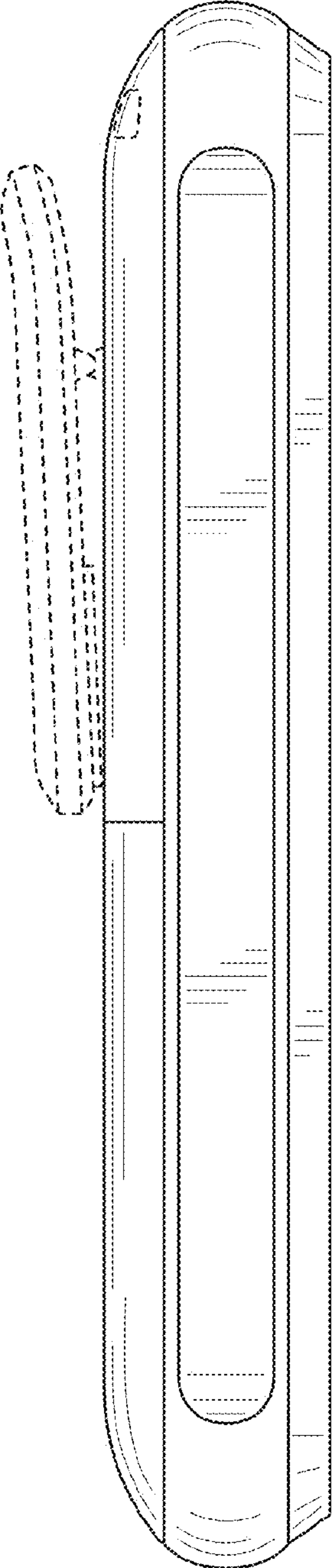

FIG. 5

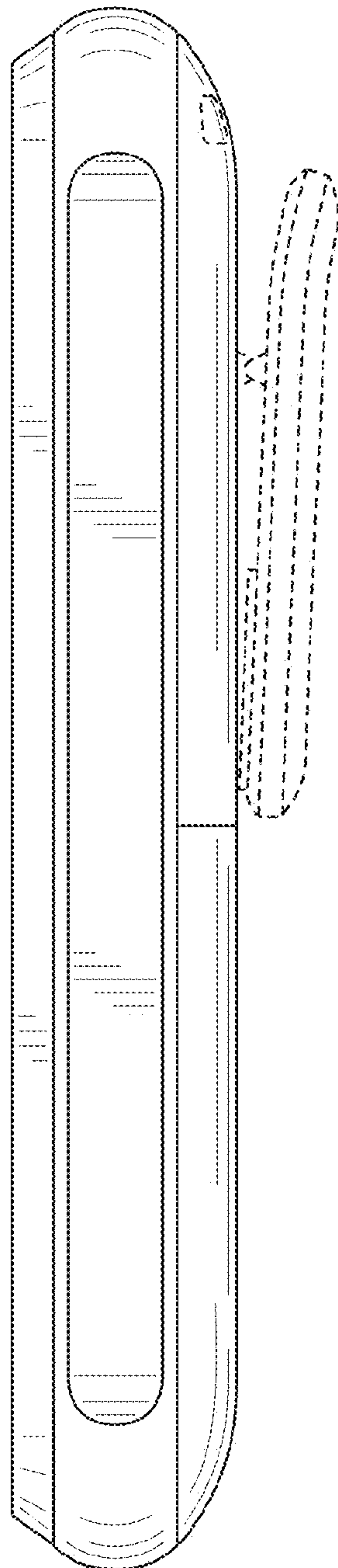

FIG. 6

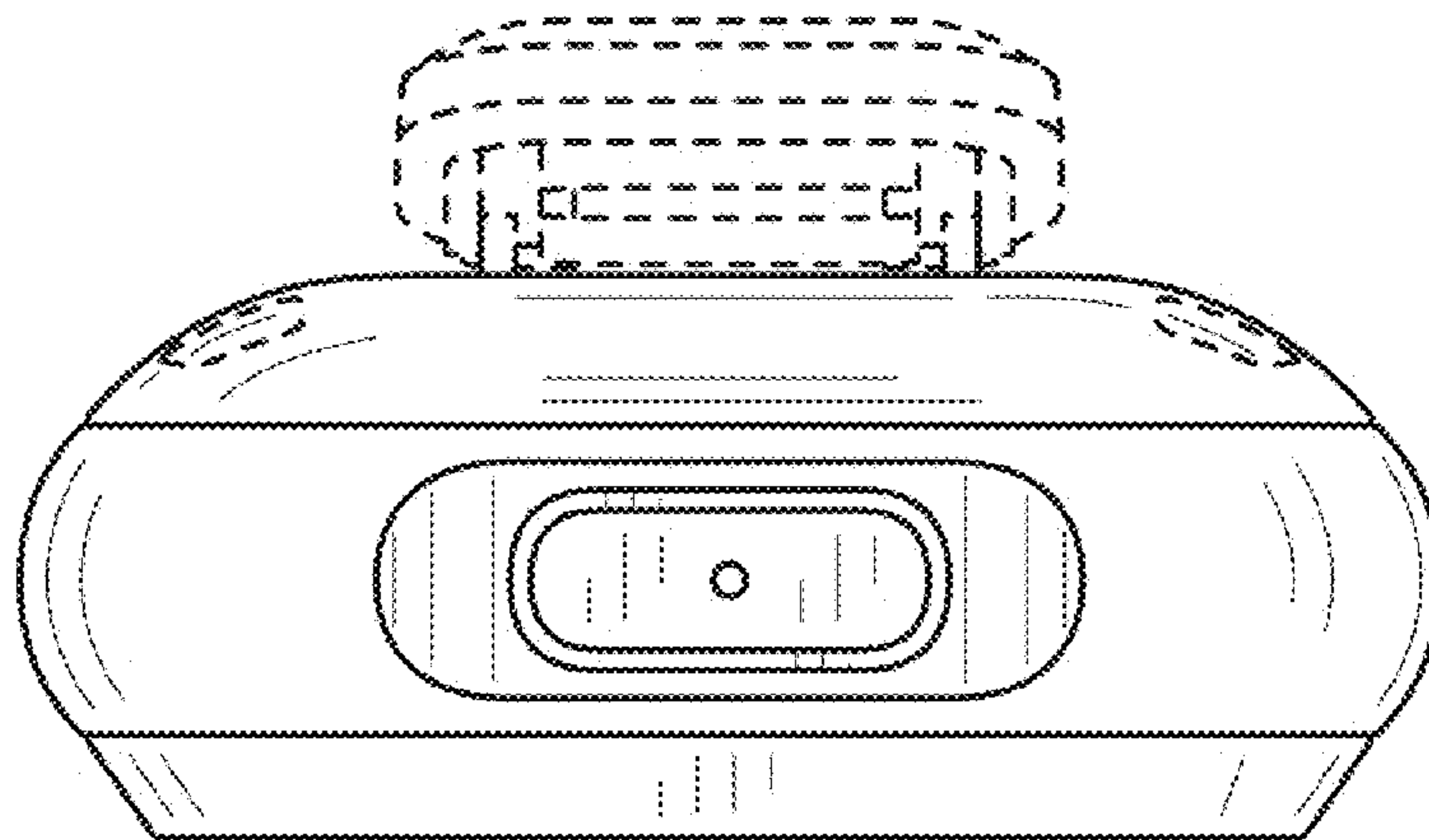

FIG. 7

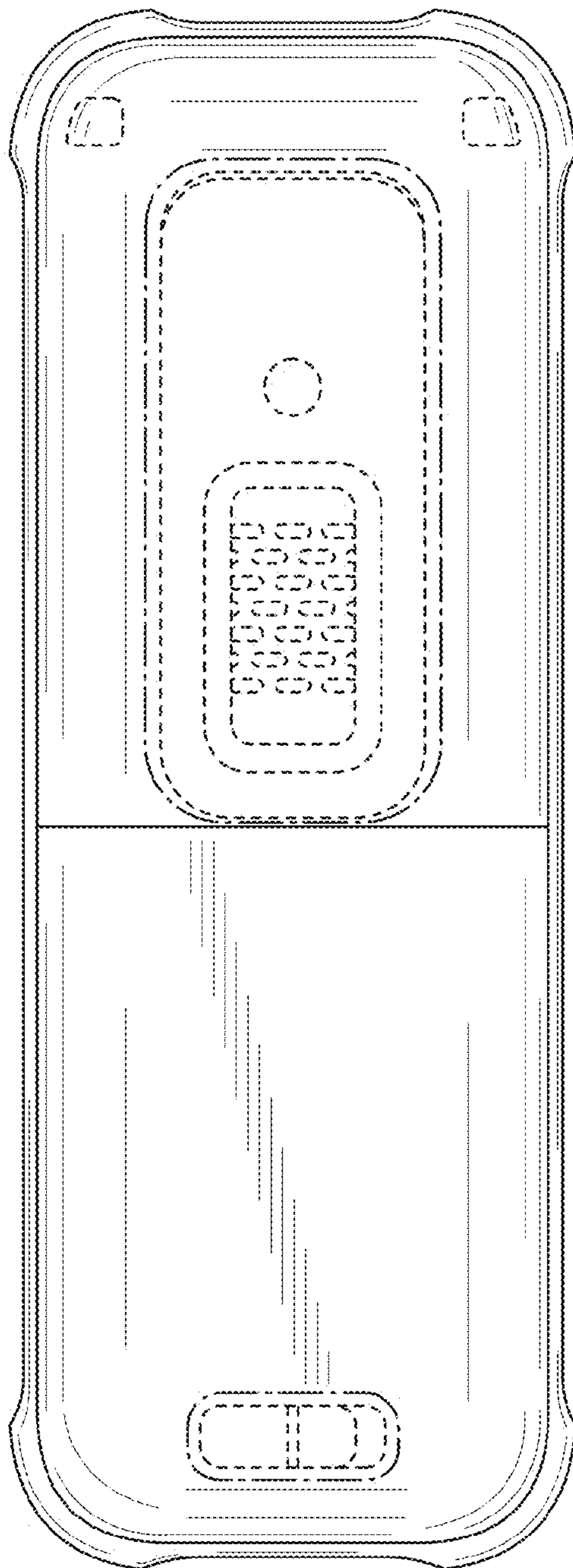

FIG. 8

