



US00D677224S

(12) **United States Design Patent**
Chen et al.

(10) **Patent No.:** **US D677,224 S**
(45) **Date of Patent:** **** Mar. 5, 2013**

(54) **POWER SUPPLY**

(76) Inventors: **Michael Chen**, Irvine, CA (US); **Wen Wei**, San Ramon, CA (US); **Billy Chen**, Irvine, CA (US)

(**) Term: **14 Years**

(21) Appl. No.: **29/429,975**

(22) Filed: **Aug. 20, 2012**

(51) **LOC (9) Cl.** **13-02**

(52) **U.S. Cl.** **D13/110**

(58) **Field of Classification Search** D13/110,
D13/101, 118, 123, 162, 184, 199; D14/300,
D14/301, 355; 307/150; 361/601, 622, 695,
361/714, 724, 725, 726, 730, 752, 753; 363/144;
439/76.1; 340/693.5, 693.12

See application file for complete search history.

(56) **References Cited**

U.S. PATENT DOCUMENTS

D375,937	S	*	11/1996	Mergenthaler et al.	D13/110
5,793,627	A	*	8/1998	Caldes et al.	363/146
D456,352	S	*	4/2002	Germagian et al.	D13/110
D463,363	S	*	9/2002	Veino et al.	D13/110
D568,814	S	*	5/2008	Hung	D13/123
D573,533	S	*	7/2008	Soeda et al.	D13/110

D599,288	S	*	9/2009	Radle et al.	D13/123
D615,035	S	*	5/2010	Farris-Gilbert	D13/110
D615,492	S	*	5/2010	Mibayashi	D13/110

* cited by examiner

Primary Examiner — Derrick Holland

(74) *Attorney, Agent, or Firm* — QuickPatents; Kevin Prince

(57) **CLAIM**

We claim the ornamental design for a power supply, as shown and described.

DESCRIPTION

FIG. 1 is a perspective view of a power supply, showing our new design;

FIG. 2 is a front elevational view thereof;

FIG. 3 is a rear elevational view thereof;

FIG. 4 is a right-side elevational view thereof, the left-side elevational view being a mirror image thereof;

FIG. 5 is a top plan view thereof; and,

FIG. 6 is a bottom plan view thereof.

The broken lines showing a knob, buttons, power and signal ports, and text in FIGS. 1, 2, 4 and 5 depict environmental matter and form no part of the claimed design.

The broken lines showing a knob, buttons, power and signal ports, and text in FIGS. 1, 2, 3, and 5 depict environmental subject matter and form no part of the claimed design.

1 Claim, 3 Drawing Sheets

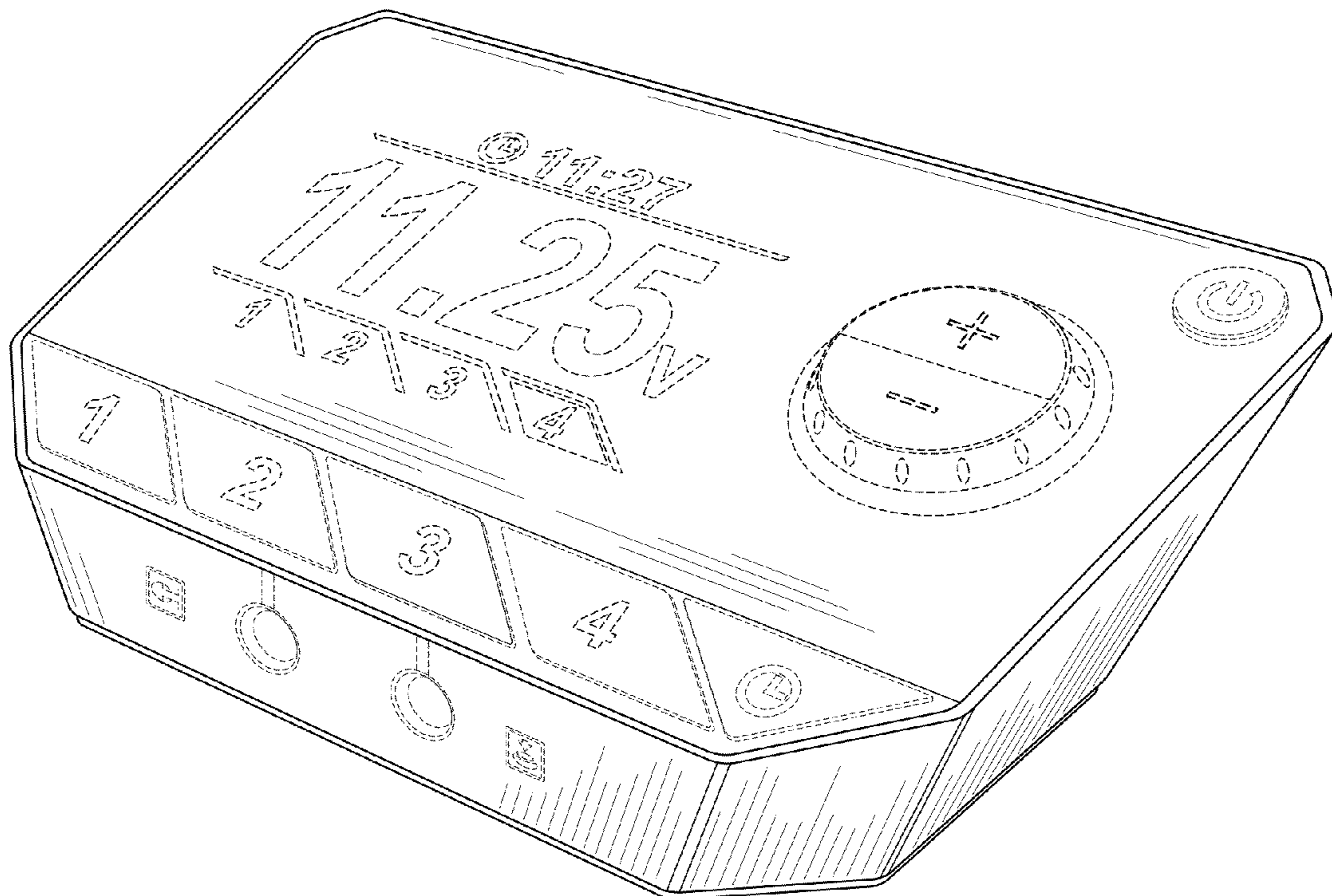

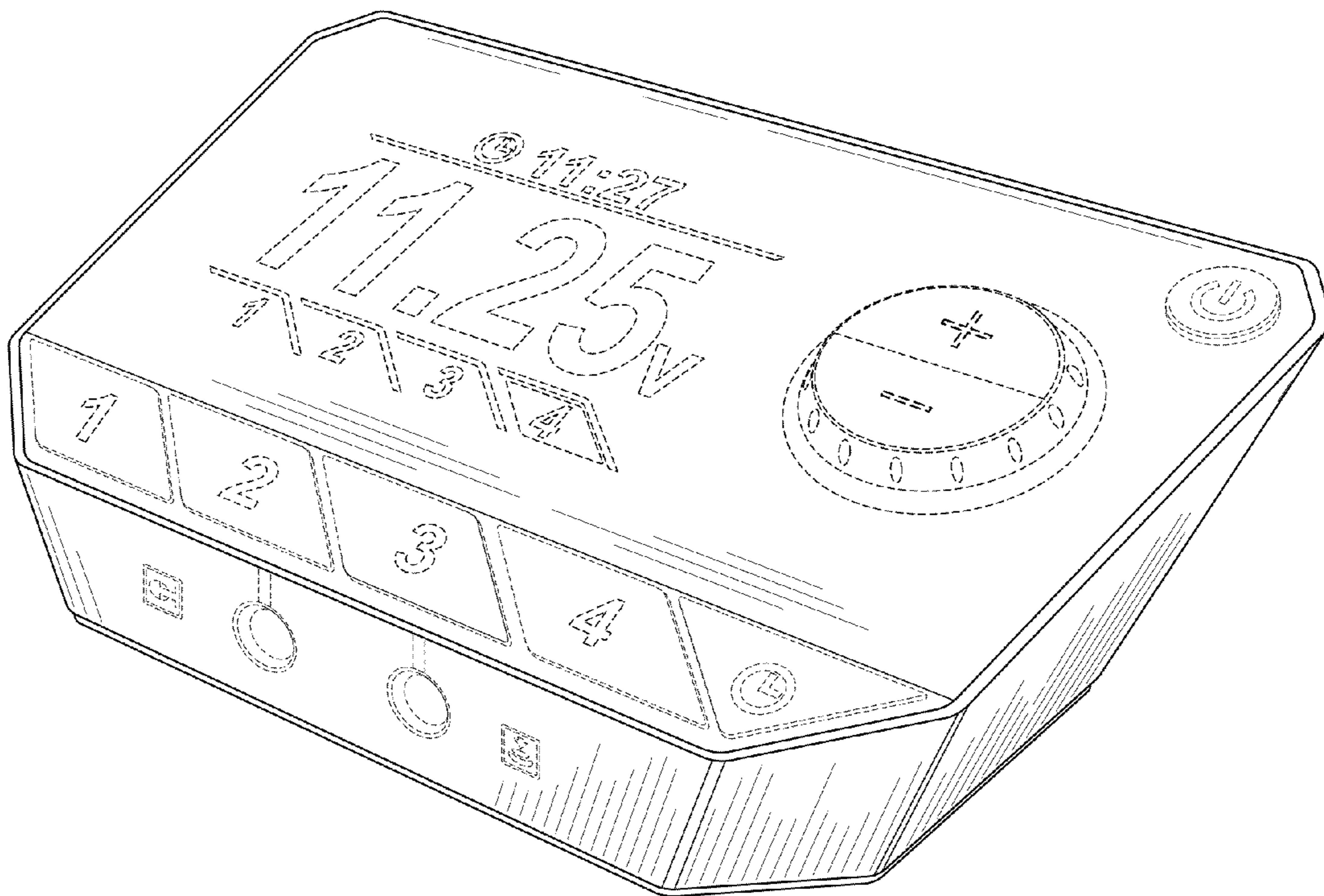

FIG. 1

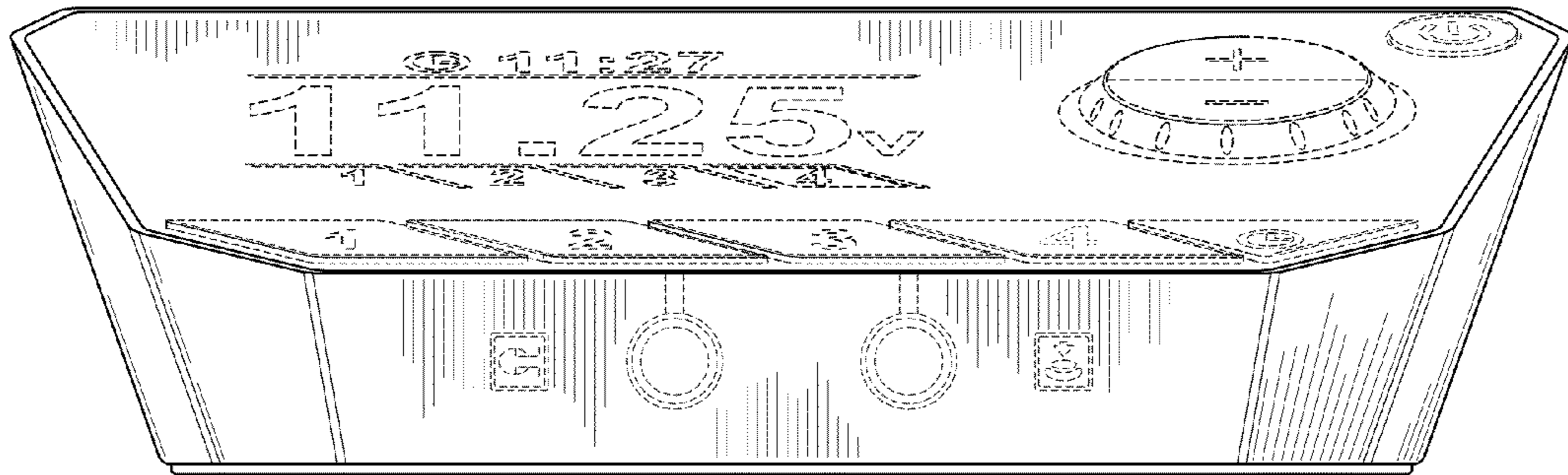

FIG. 2

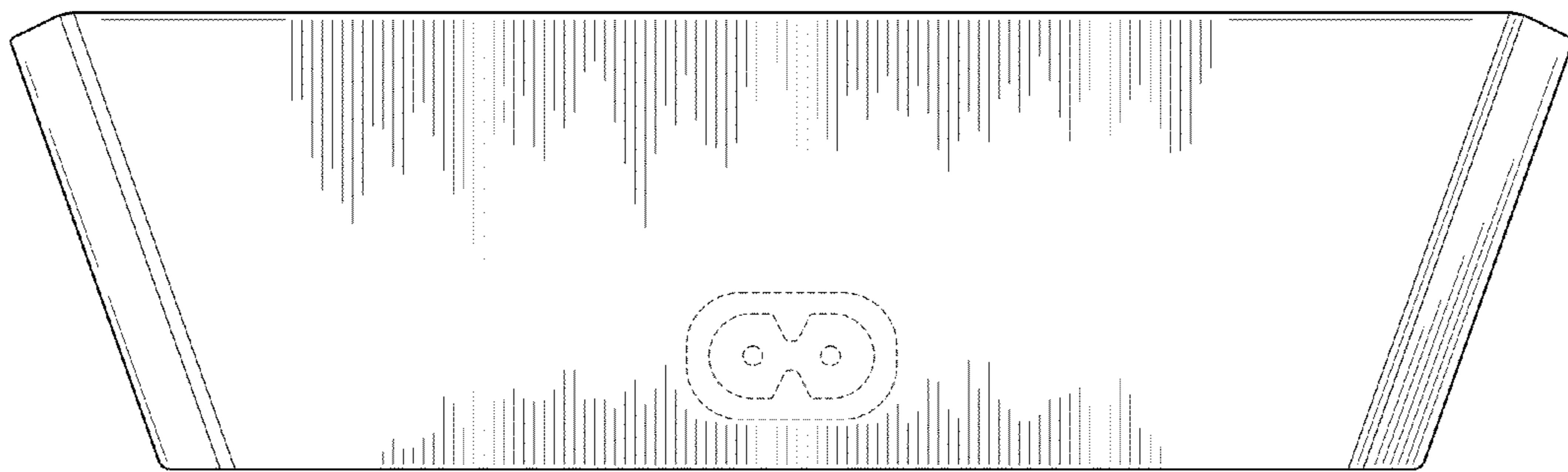

FIG. 3

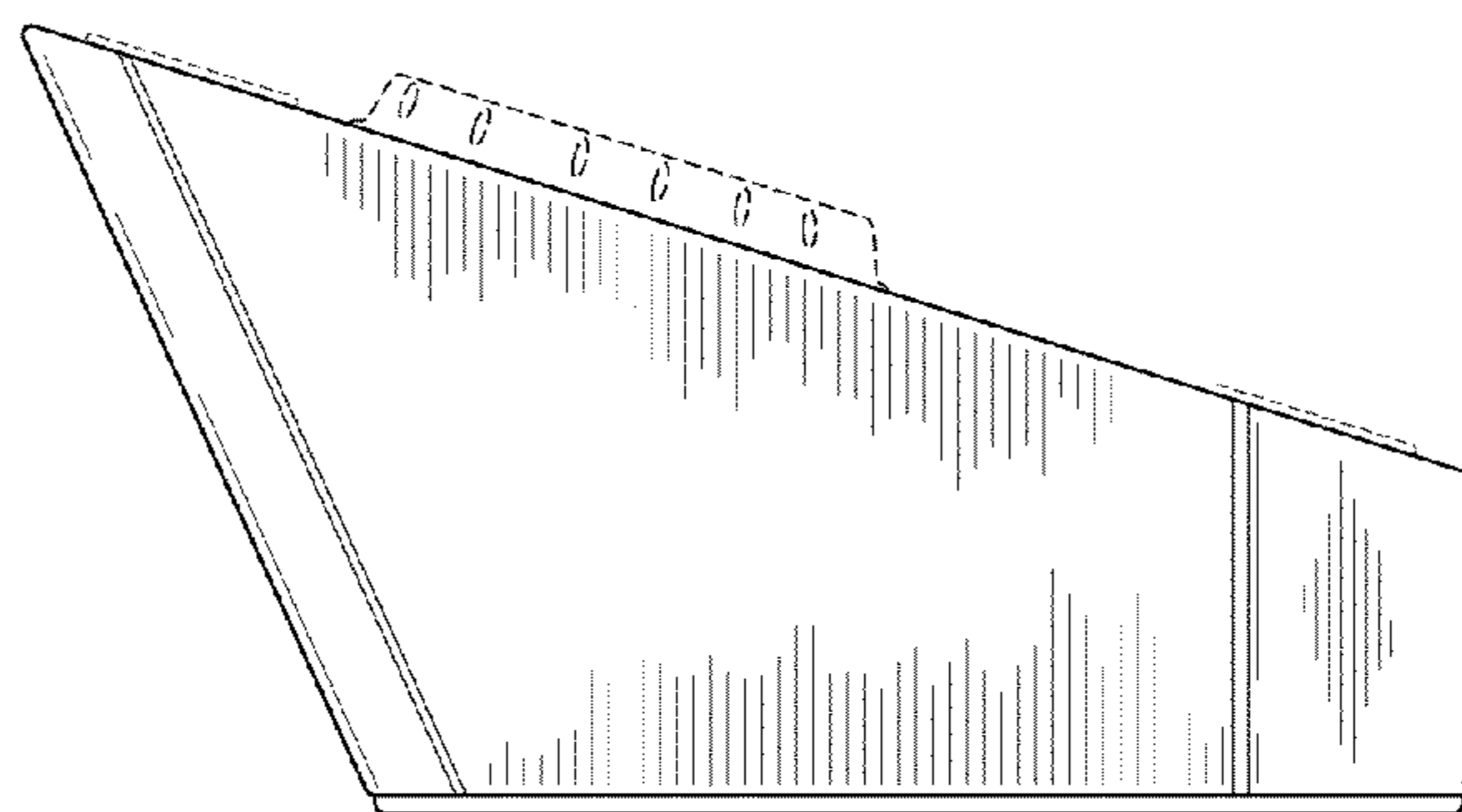

FIG. 4

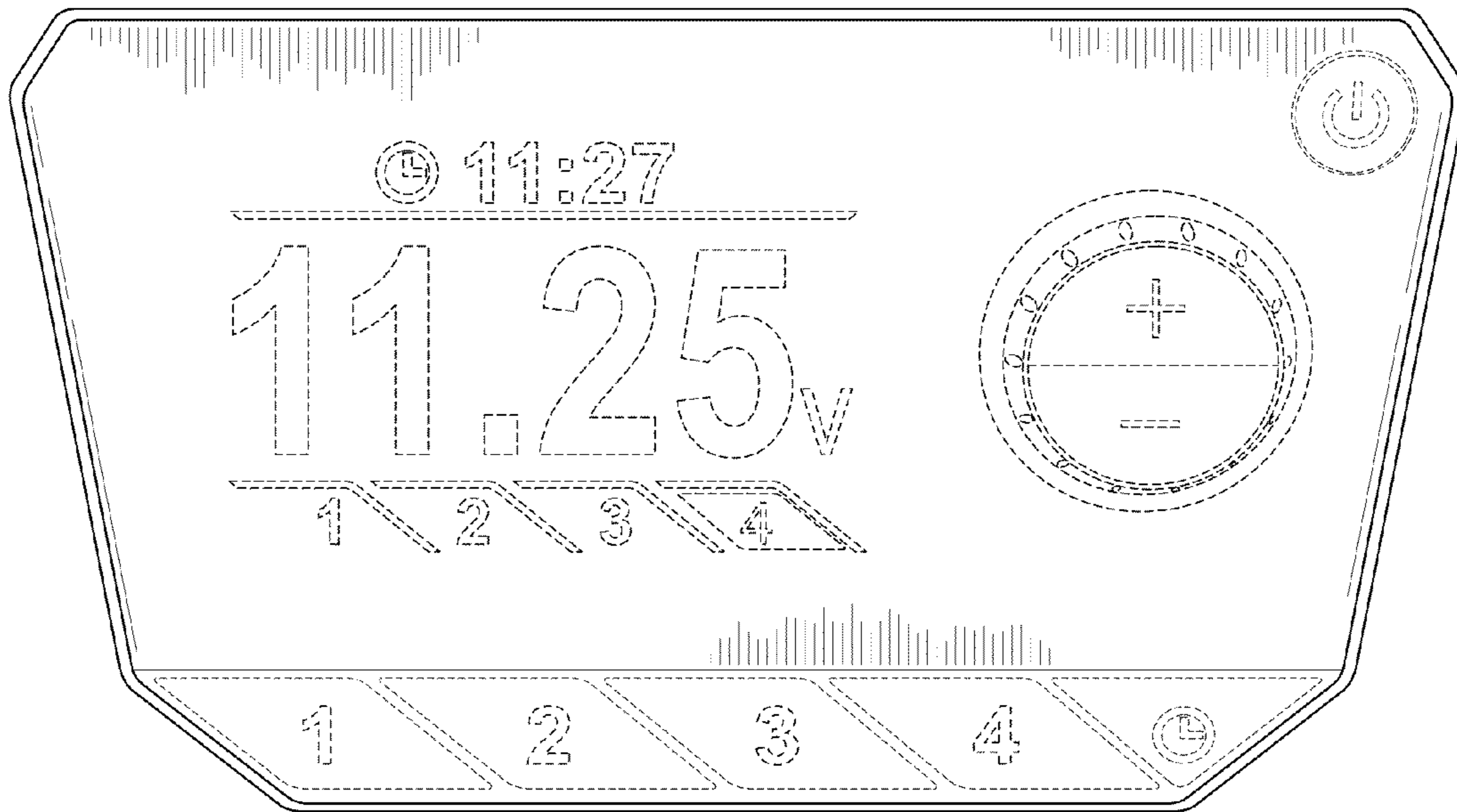

FIG. 5

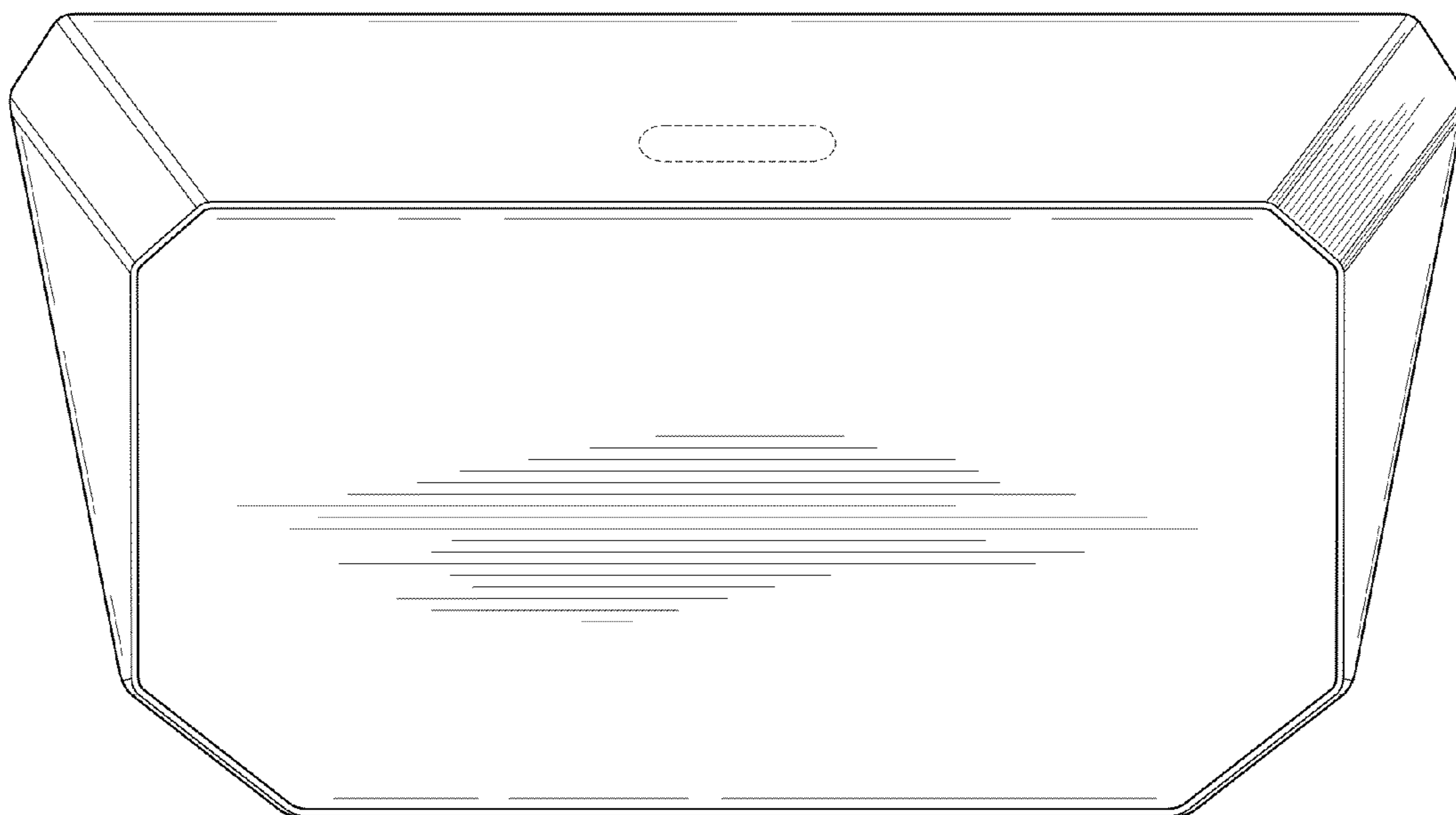

FIG. 6