



US00D677217S

(12) **United States Design Patent**
Iwabuchi

(10) **Patent No.:** **US D677,217 S**
(45) **Date of Patent:** **** Mar. 5, 2013**

(54) **SIDEWALL PORTION OF AN AUTOMOBILE TIRE**

(75) Inventor: **Sotaro Iwabuchi**, Tokyo (JP)

(73) Assignee: **Bridgestone Corporation**, Tokyo (JP)

(**) Term: **14 Years**

(21) Appl. No.: **29/407,452**

(22) Filed: **Nov. 29, 2011**

(30) **Foreign Application Priority Data**

May 30, 2011 (JP) 2011-012125

(51) **LOC (9) Cl.** **12-15**

(52) **U.S. Cl.** **D12/605**

(58) **Field of Classification Search** D12/500-501,
D12/544, 579, 600-605; 152/523-524, DIG. 12,
152/555; D7/588, 396.4-396.5

See application file for complete search history.

(56) **References Cited**

U.S. PATENT DOCUMENTS

D206,986 S *	2/1967	Makris	D12/605
D207,572 S *	5/1967	Ueno	D12/605
D385,834 S *	11/1997	Ratliff, Jr.	D12/605
D543,499 S *	5/2007	Shondel	D12/605
D550,150 S *	9/2007	Shondel	D12/605
D555,583 S *	11/2007	Itoi	D12/605
D569,336 S *	5/2008	Onoe	D12/605
D584,222 S *	1/2009	Ohashi	D12/605
D590,332 S *	4/2009	Sato	D12/605
D593,486 S *	6/2009	Yonetsu	D12/605

D596,117 S *	7/2009	Yonetsu	D12/605
D596,118 S *	7/2009	Frappart	D12/605
D618,165 S *	6/2010	Sato	D12/605
D626,502 S *	11/2010	Nakamura	D12/605
D632,641 S *	2/2011	Sato	D12/605
D655,671 S *	3/2012	Yasunaga	D12/605
D662,466 S *	6/2012	Takano	D12/605
D662,877 S *	7/2012	Arrant et al.	D12/605

* cited by examiner

Primary Examiner — Stacia Cadmus

(74) *Attorney, Agent, or Firm* — Sughrue Mion, PLLC

(57) **CLAIM**

The ornamental design for a sidewall portion of an automobile tire, as shown and described.

DESCRIPTION

FIG. 1 is a perspective view of a sidewall portion of an automobile tire according to my design;
 FIG. 2 is a front view thereof;
 FIG. 3 is a plane view thereof;
 FIG. 4 is a right side view thereof;
 FIG. 5 is a left side view thereof;
 FIG. 6 is a rear view thereof;
 FIG. 7 is a bottom view thereof;
 FIG. 8 is a fragmentary enlarged view showing the details of the sidewall portion defined by cross-section by lines A-A and B-B in FIG. 2 thereof; and,
 FIG. 9 is an end view taken along line 9-9 in FIG. 8 thereof.
 Broken lines in the drawing figures are used to show unclaimed portions of the tire, and thus form no part of the claimed design.

1 Claim, 9 Drawing Sheets

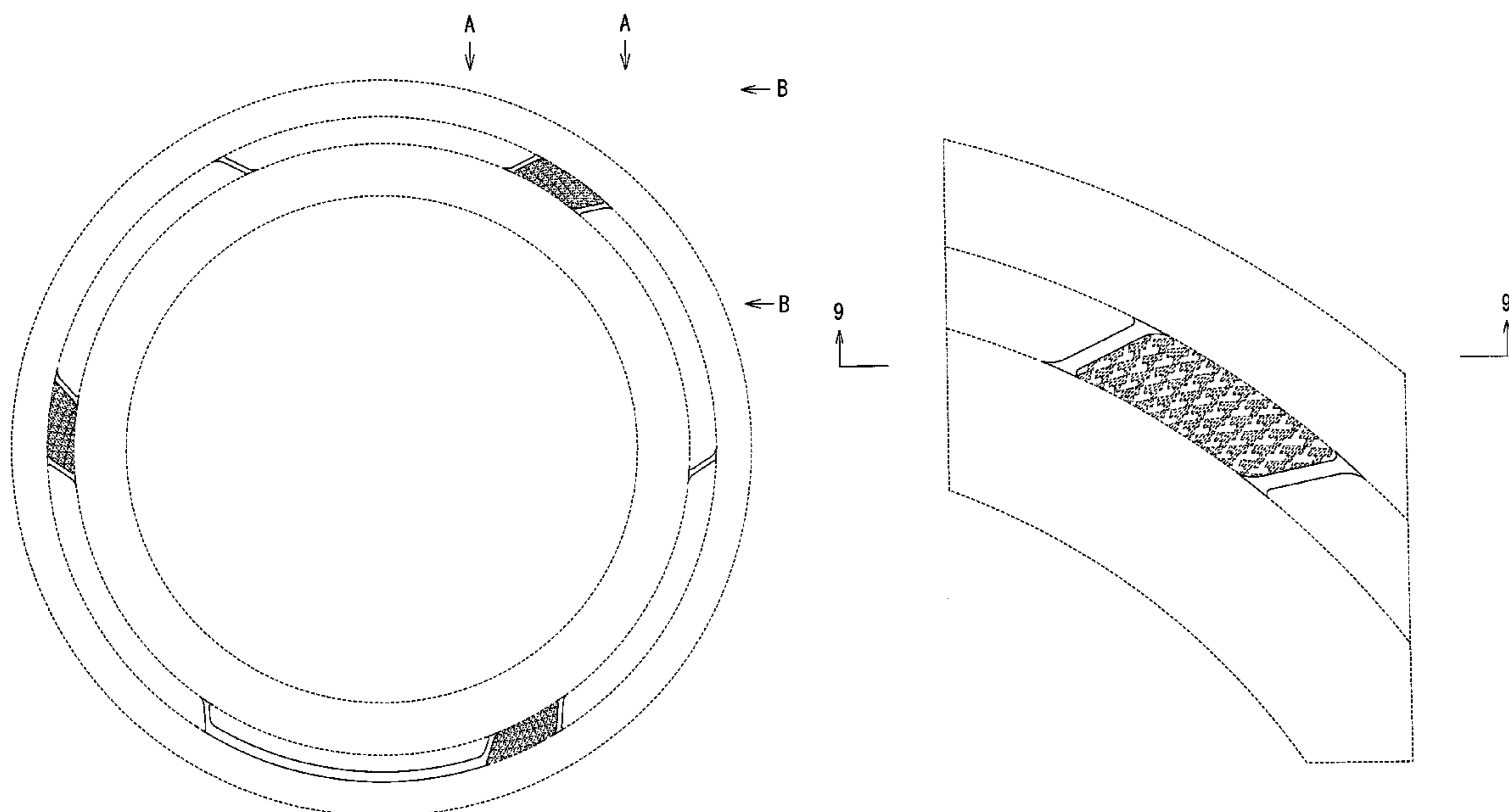

FIG. 1

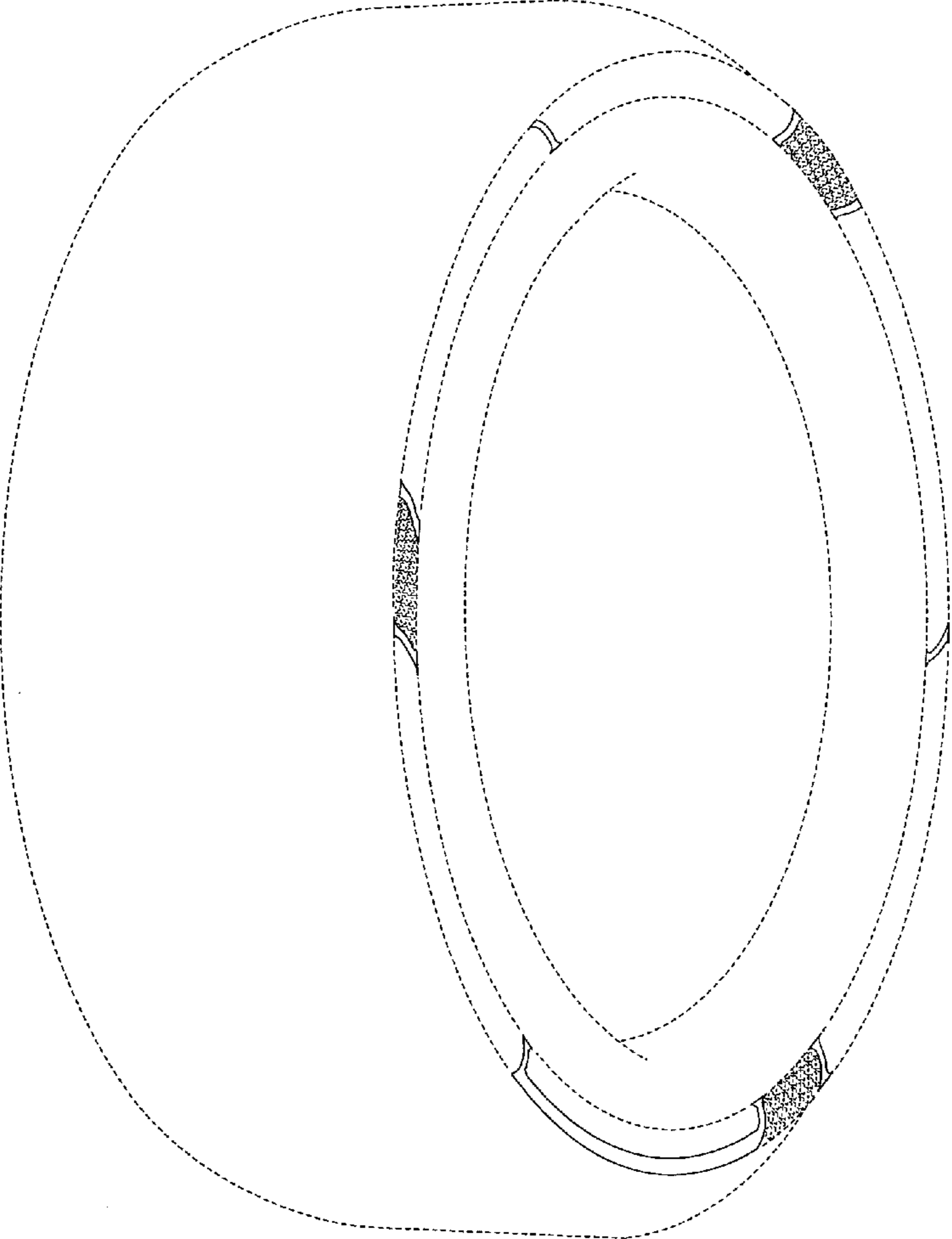

FIG.2

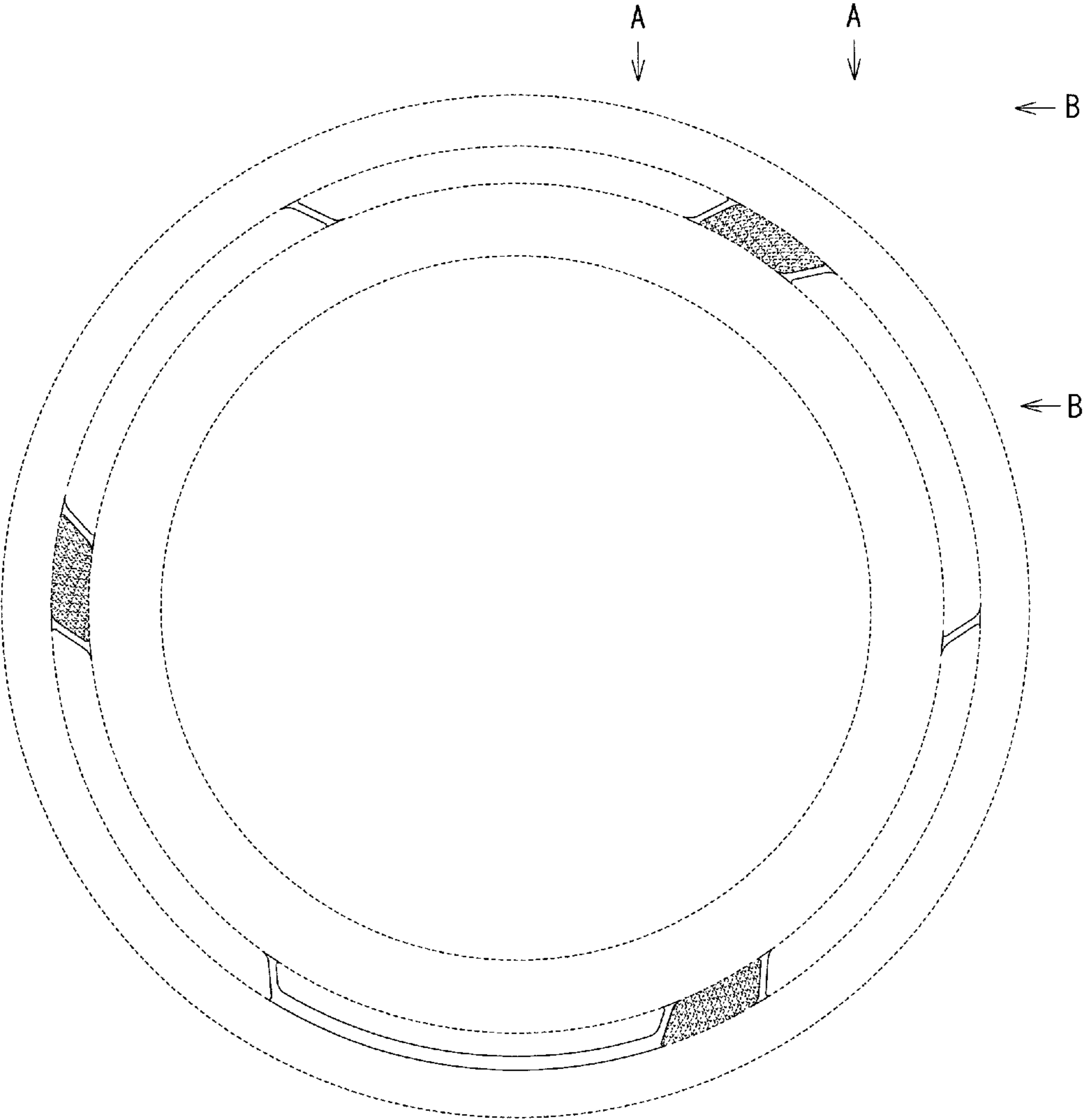

FIG. 3

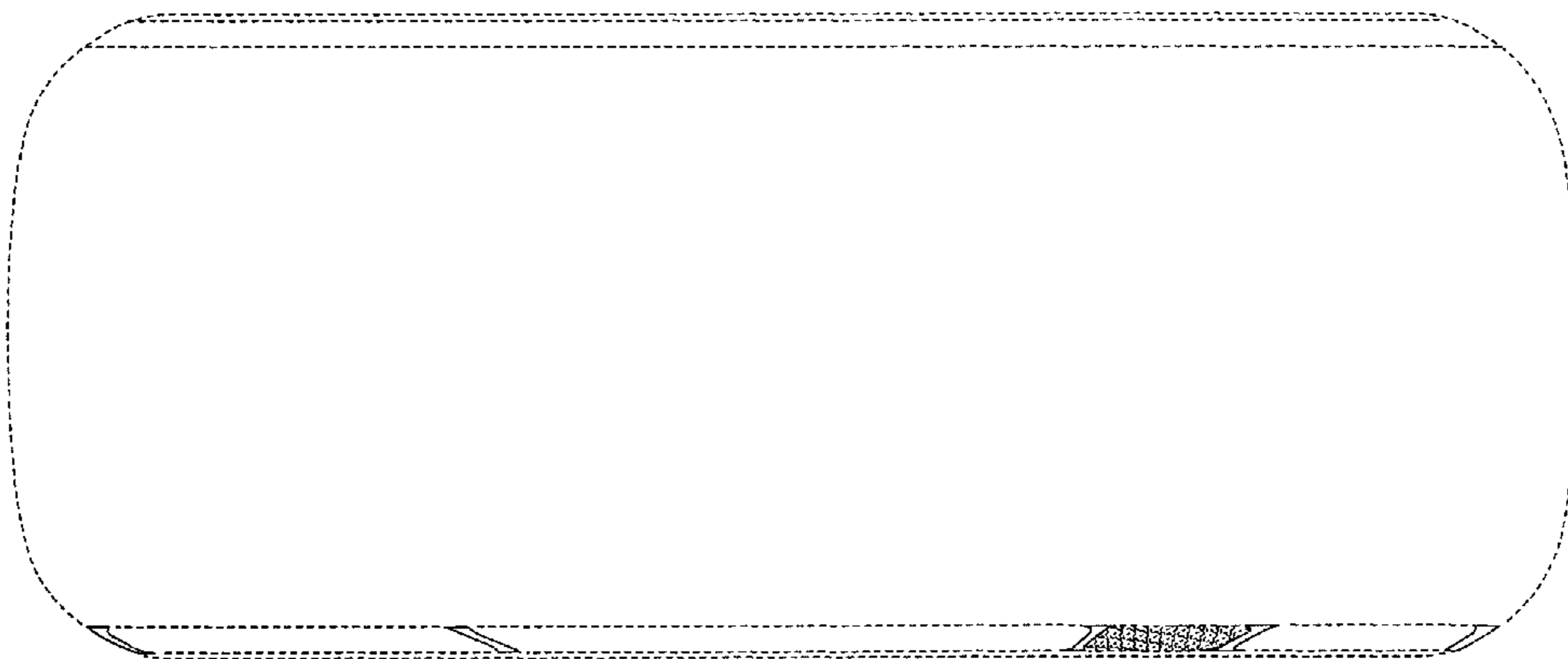

FIG. 4

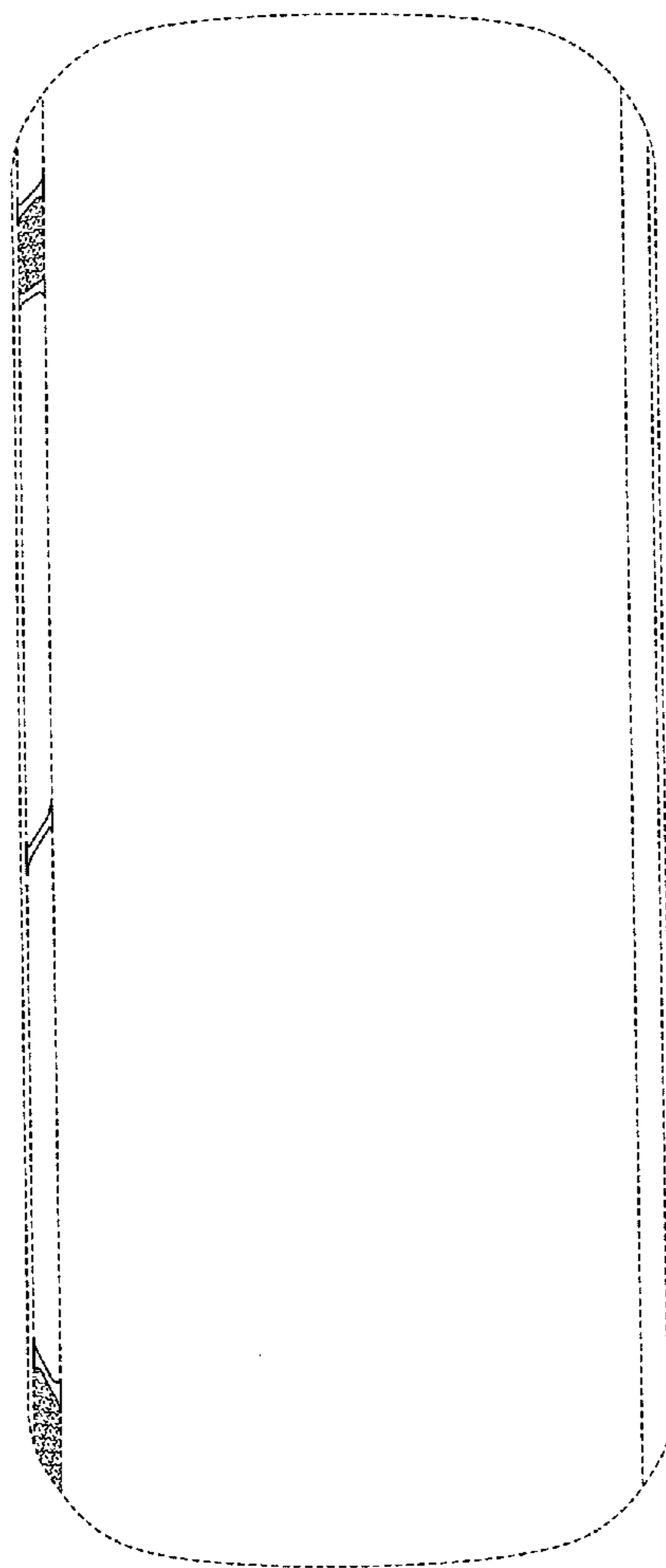

FIG. 5

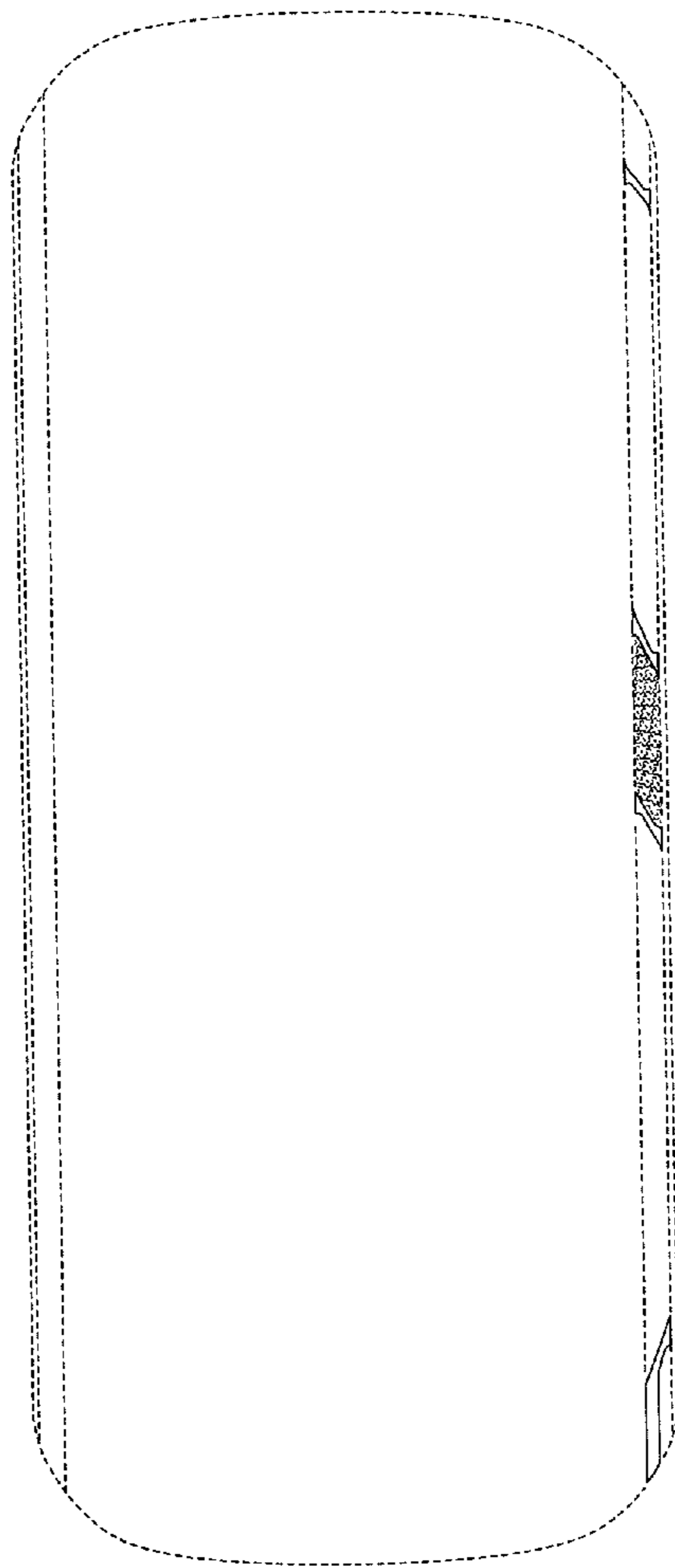

FIG. 6

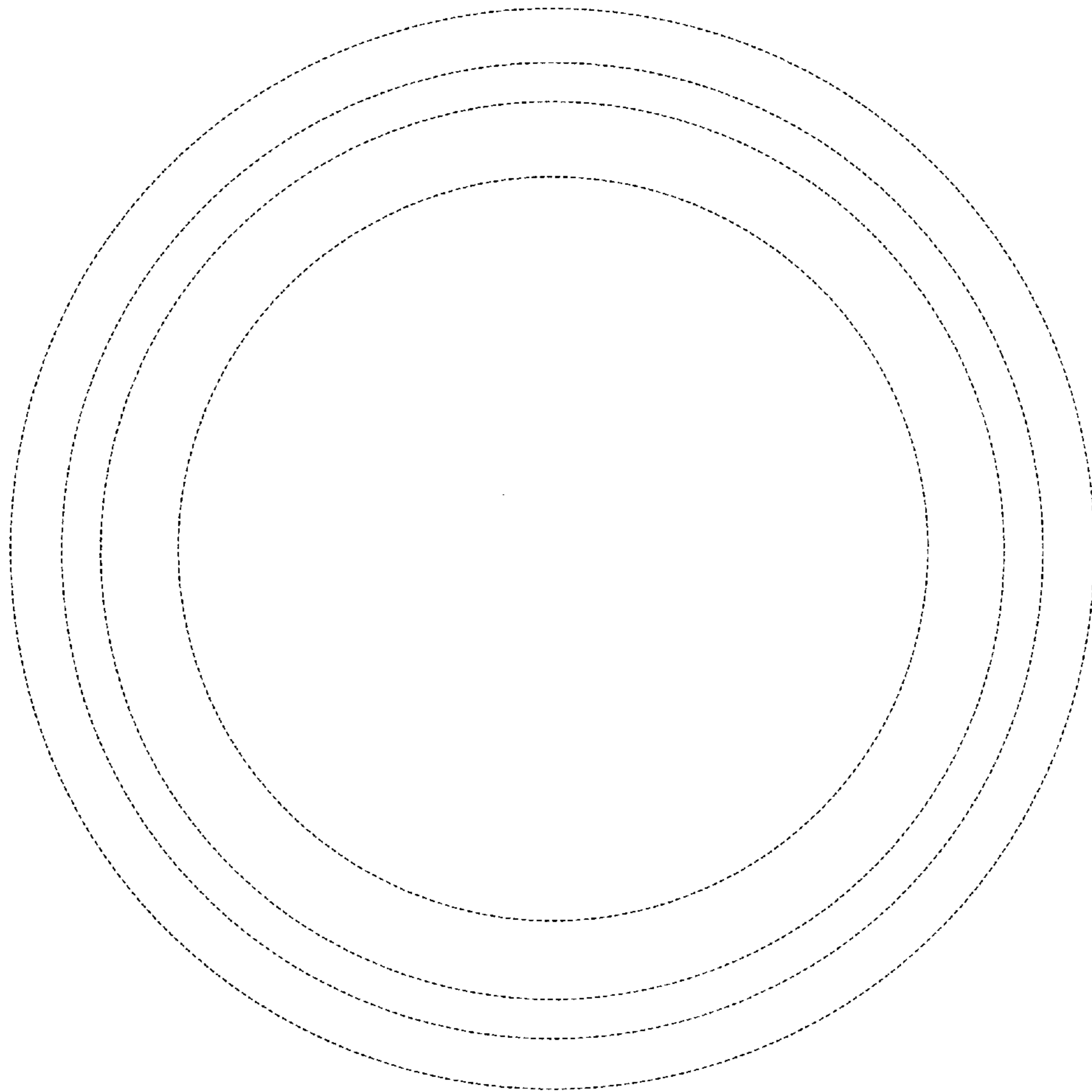

FIG. 7

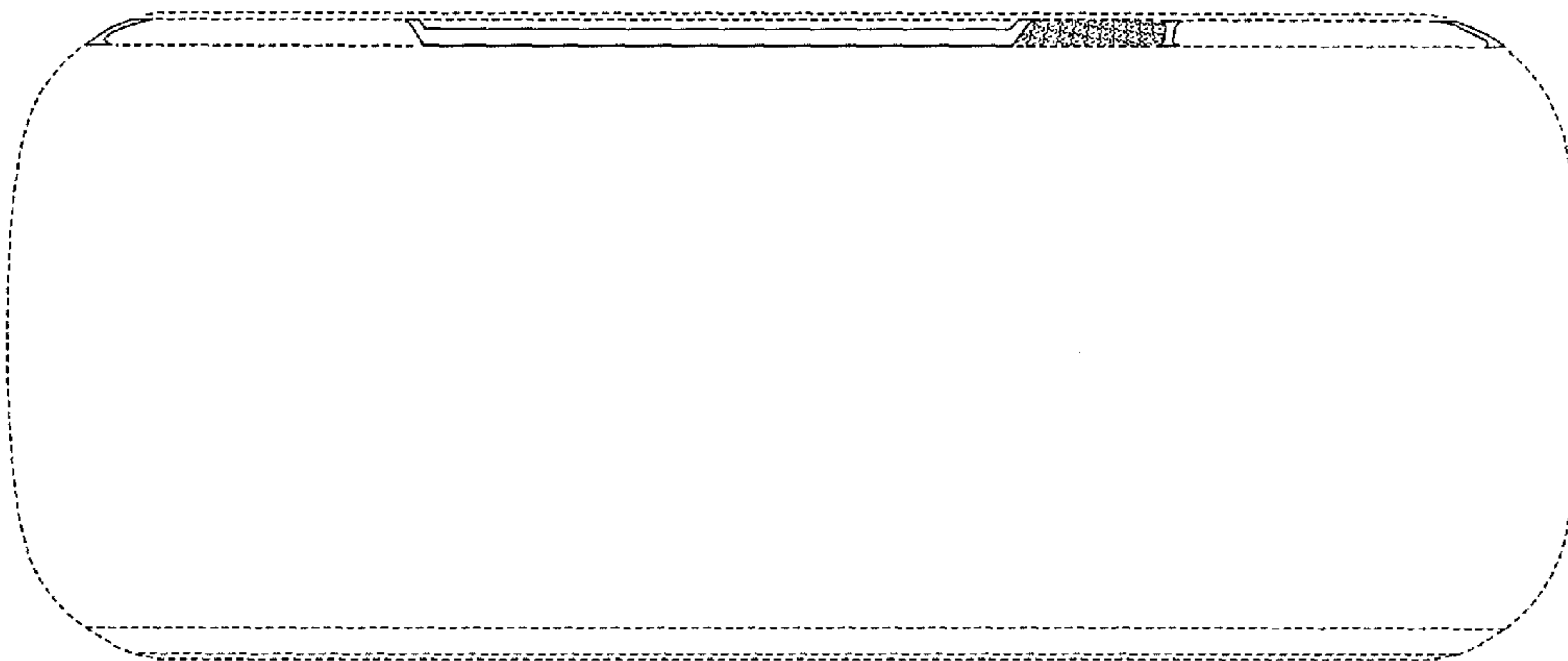

FIG. 8

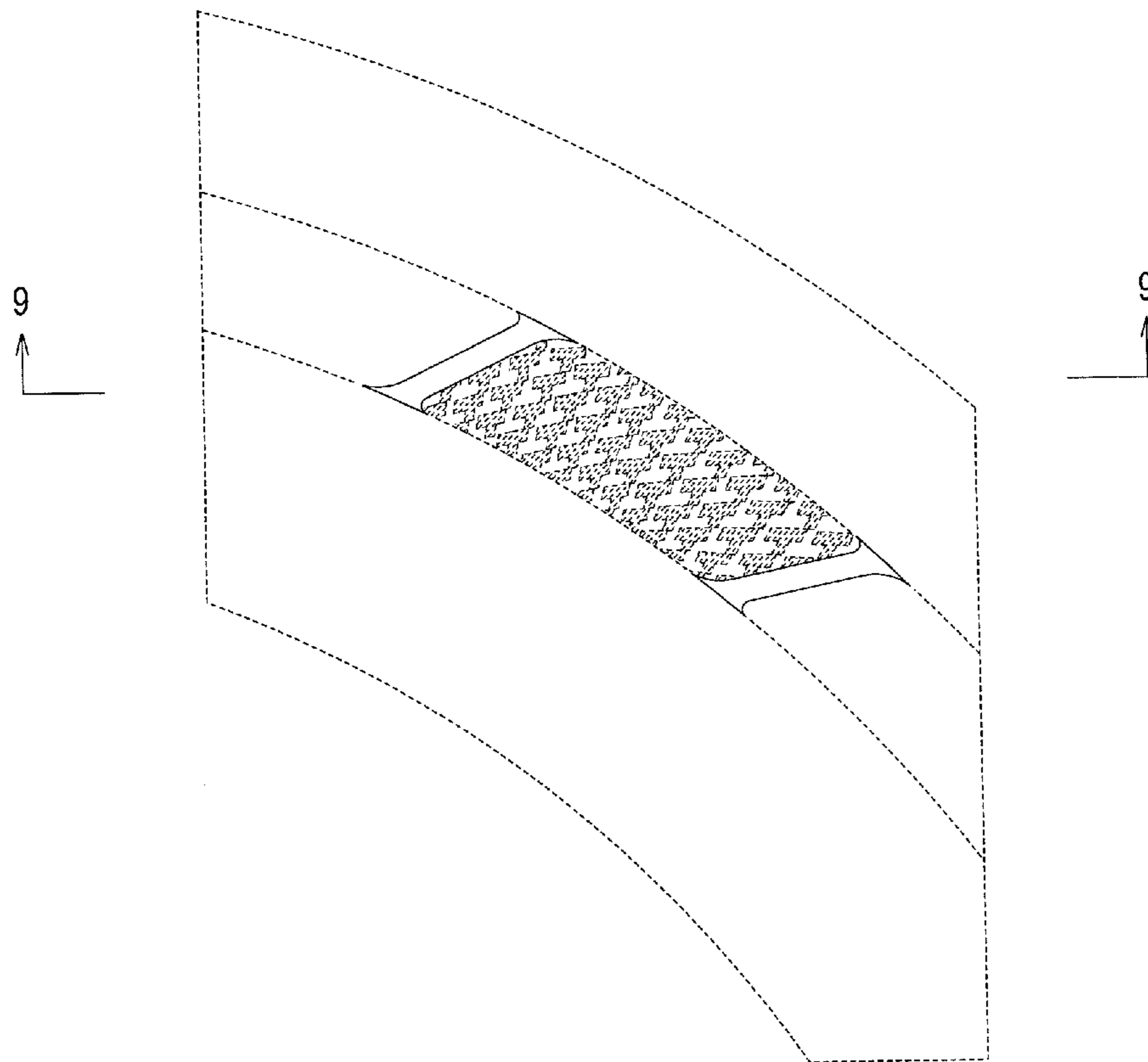

FIG. 9

