



US00D677182S

(12) **United States Design Patent**  
**Lee et al.**

(10) **Patent No.:** **US D677,182 S**  
(45) **Date of Patent:** **\*\* Mar. 5, 2013**

(54) **NAVIGATION DEVICE**

(75) Inventors: **Juhee Lee**, Olathe, KS (US); **Derrick D. Lenz**, Olathe, KS (US); **Warren R. Stevens**, Olathe, KS (US); **John R. Tines**, Olathe, KS (US)

(73) Assignee: **Garmin Switzerland GmbH** (CH)

(\*\*) Term: **14 Years**

(21) Appl. No.: **29/428,099**

(22) Filed: **Jul. 26, 2012**

(51) **LOC (9) Cl.** ..... **10-04**

(52) **U.S. Cl.** ..... **D10/65; D10/70**

(58) **Field of Classification Search** ..... D10/65,  
D10/70, 104.2, 106.6; D14/315, 336, 337,  
D14/341, 342, 343, 240–242, 356–358, 371,  
D14/140.1–140.6, 140, 155, 159, 137, 149,  
D14/150, 217, 170–171, 125, 188, 203.3,  
D14/203.4, 203.7; 342/386, 351, 419, 457,  
342/357.2–357.78, 450, 458; 343/702; 345/87,  
345/104, 133, 156, 168, 173, 901–905; 348/180,  
348/184, 315, 739; 364/444, 499; 701/23–28,  
701/400, 408, 409, 468–491, 526

See application file for complete search history.

(56) **References Cited**

**U.S. PATENT DOCUMENTS**

D543,876 S	6/2007	Kalis et al. ....	D10/65
D549,603 S	8/2007	Lammers-Meis et al. ....	D10/74
D557,151 S	* 12/2007	Clift .....	D10/65
D560,519 S	* 1/2008	Skelton et al. ....	D10/65
D561,619 S	2/2008	Miyawaki .....	D10/65
D562,708 S	* 2/2008	Skelton et al. ....	D10/65
D563,806 S	3/2008	Jeon .....	D10/65
D565,978 S	4/2008	Stevens et al. ....	D10/65
D565,979 S	4/2008	Ichikawa et al. ....	D10/65
D571,234 S	6/2008	Reeson et al. ....	D10/65
D571,235 S	6/2008	Stevens et al. ....	D10/65
D574,272 S	8/2008	Stevens et al. ....	D10/65

D575,171 S	8/2008	Miyawaki .....	D10/65
D577,298 S	9/2008	Reeson et al. ....	D10/65
D584,646 S	1/2009	Sanguinetti .....	D10/65
D589,381 S	3/2009	Gretton .....	D10/65
D589,824 S	4/2009	Gretton .....	D10/65
D592,083 S	5/2009	Stevens et al. ....	D10/65
7,567,212 B2	7/2009	Inoue et al. ....	343/702
D640,150 S	6/2011	Hansen et al. ....	D10/65
D659,563 S *	5/2012	Groener et al. ....	D10/65
2008/0259024 A1	10/2008	Nam et al. ....	345/156
2009/0043446 A1	2/2009	Drew et al. ....	701/133
2009/0160803 A1	6/2009	Hashimoto .....	345/173
2009/0189803 A1	7/2009	Beason .....	342/357.1
2009/0219259 A1	9/2009	Kwon .....	345/173

**OTHER PUBLICATIONS**

Garmin's Montana® 600 series Owner's Manual, Apr. 2011.

\* cited by examiner

*Primary Examiner* — Antoine D Davis

(74) *Attorney, Agent, or Firm* — Samuel M. Korte;  
Mohammad M. Ali

(57) **CLAIM**

The ornamental design for a navigation device, as shown and described.

**DESCRIPTION**

FIG. 1 is a front perspective view of a navigation device according to the present invention; FIG. 2 is a rear perspective view of the navigation device; FIG. 3 is a top view of the navigation device; FIG. 4 is a front view of the navigation device; FIG. 5 is a rear view of the navigation device; FIG. 6 is a bottom view of the navigation device; FIG. 7 is a left-side view of the navigation device; and, FIG. 8 is a right-side view of the navigation device. Portions of FIGS. 1 through 8 are shown in dashed lines for illustrative purposes only and form no part of the claimed design.

**1 Claim, 4 Drawing Sheets**

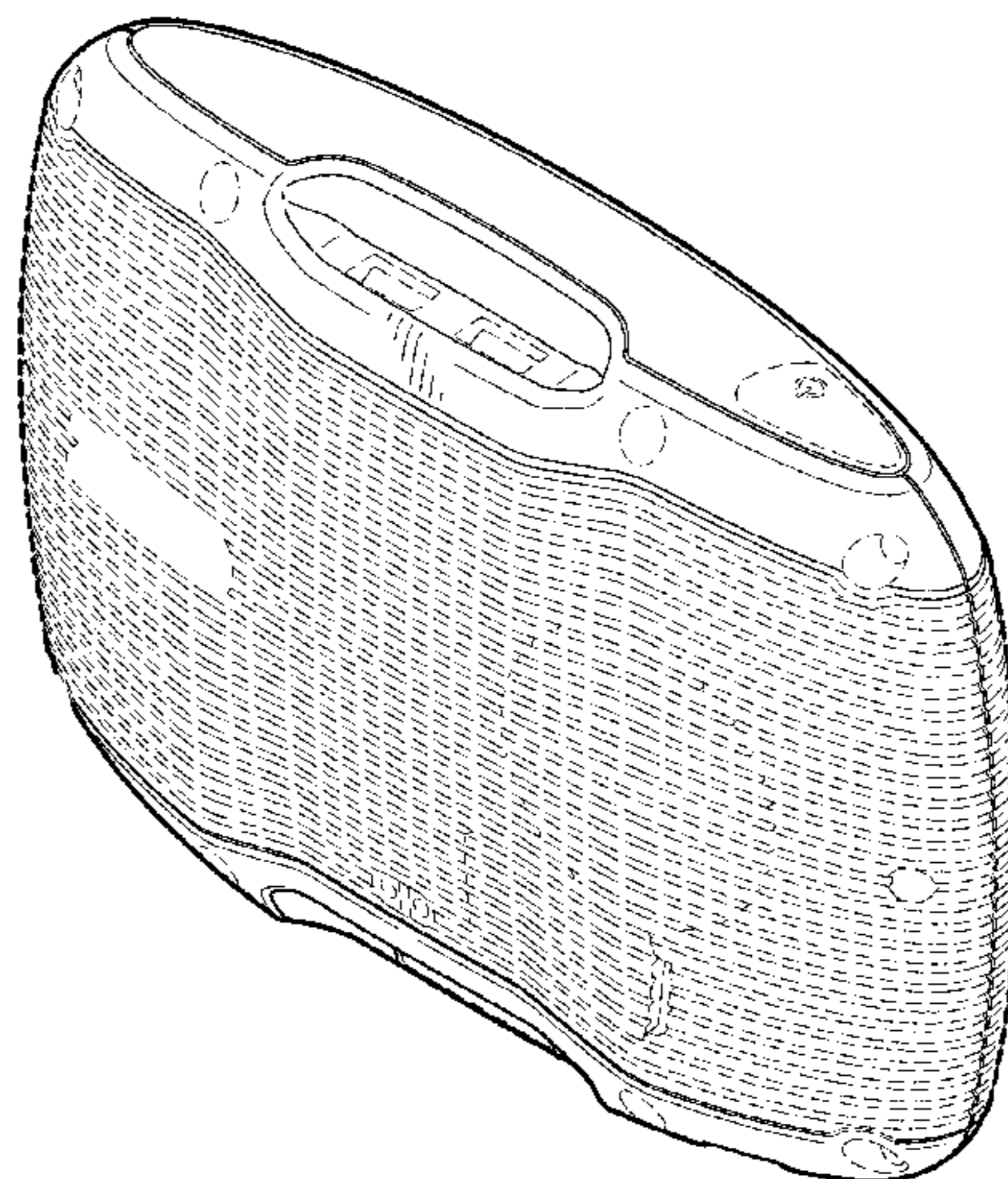
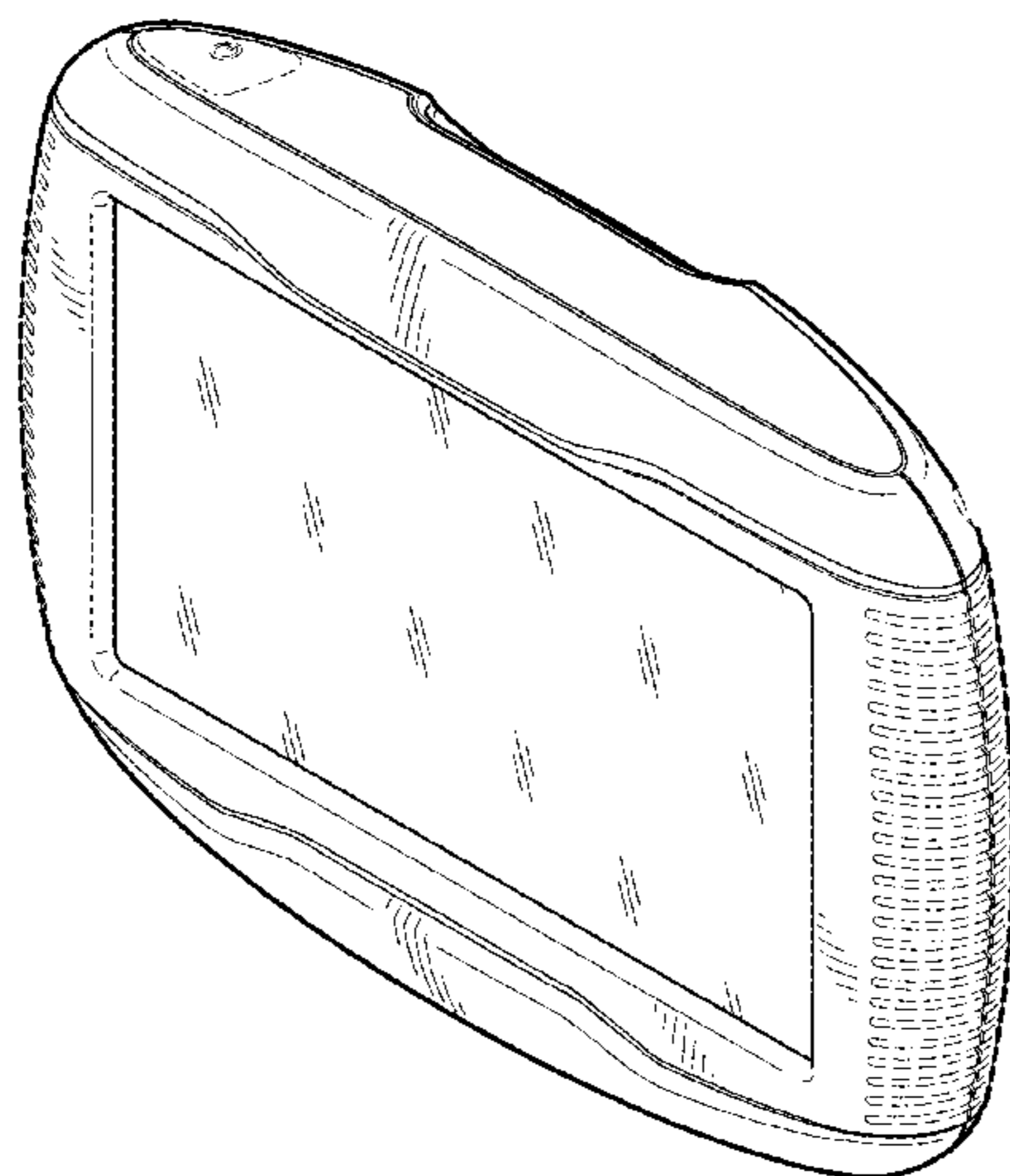

*Fig. 1*

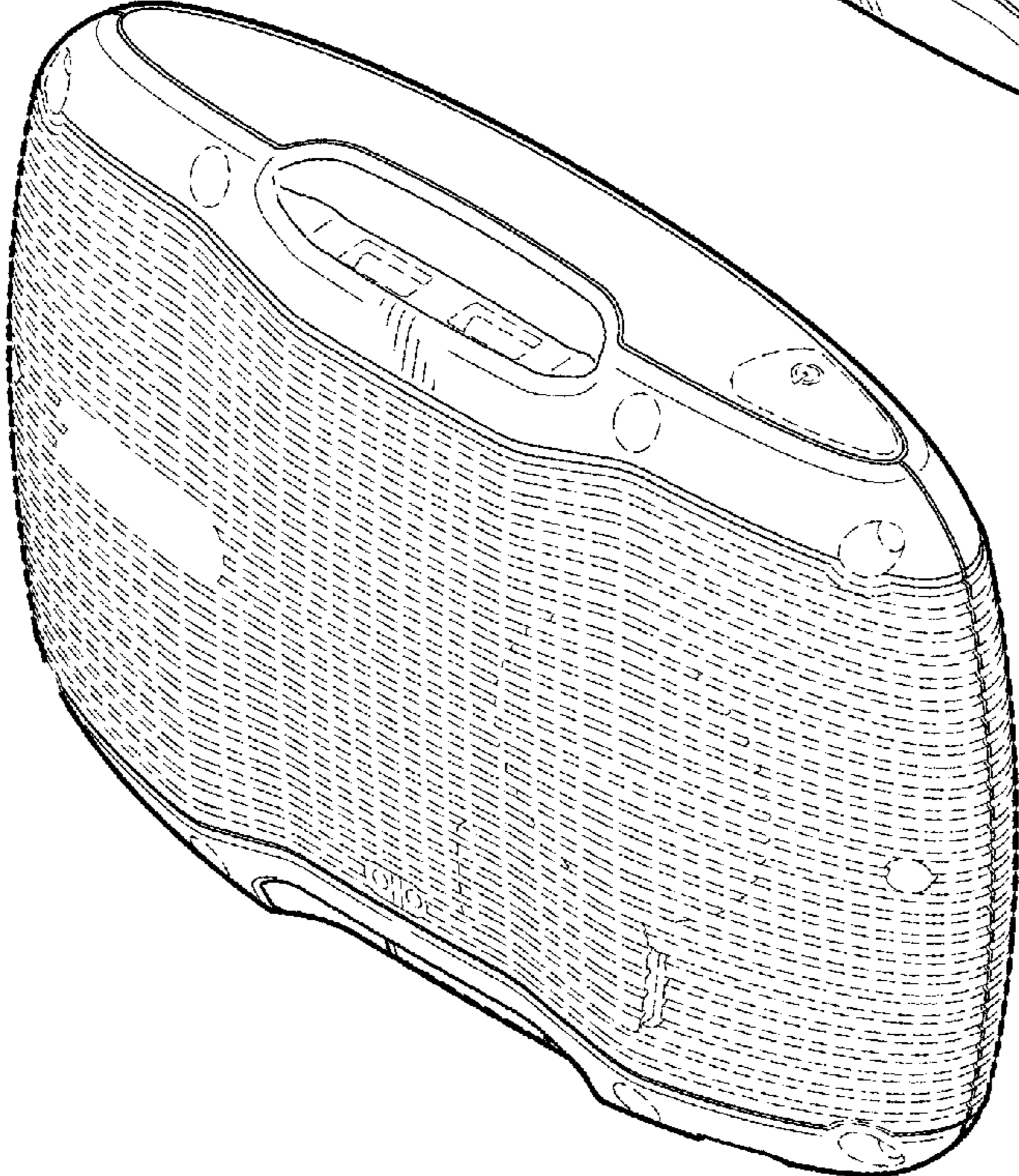
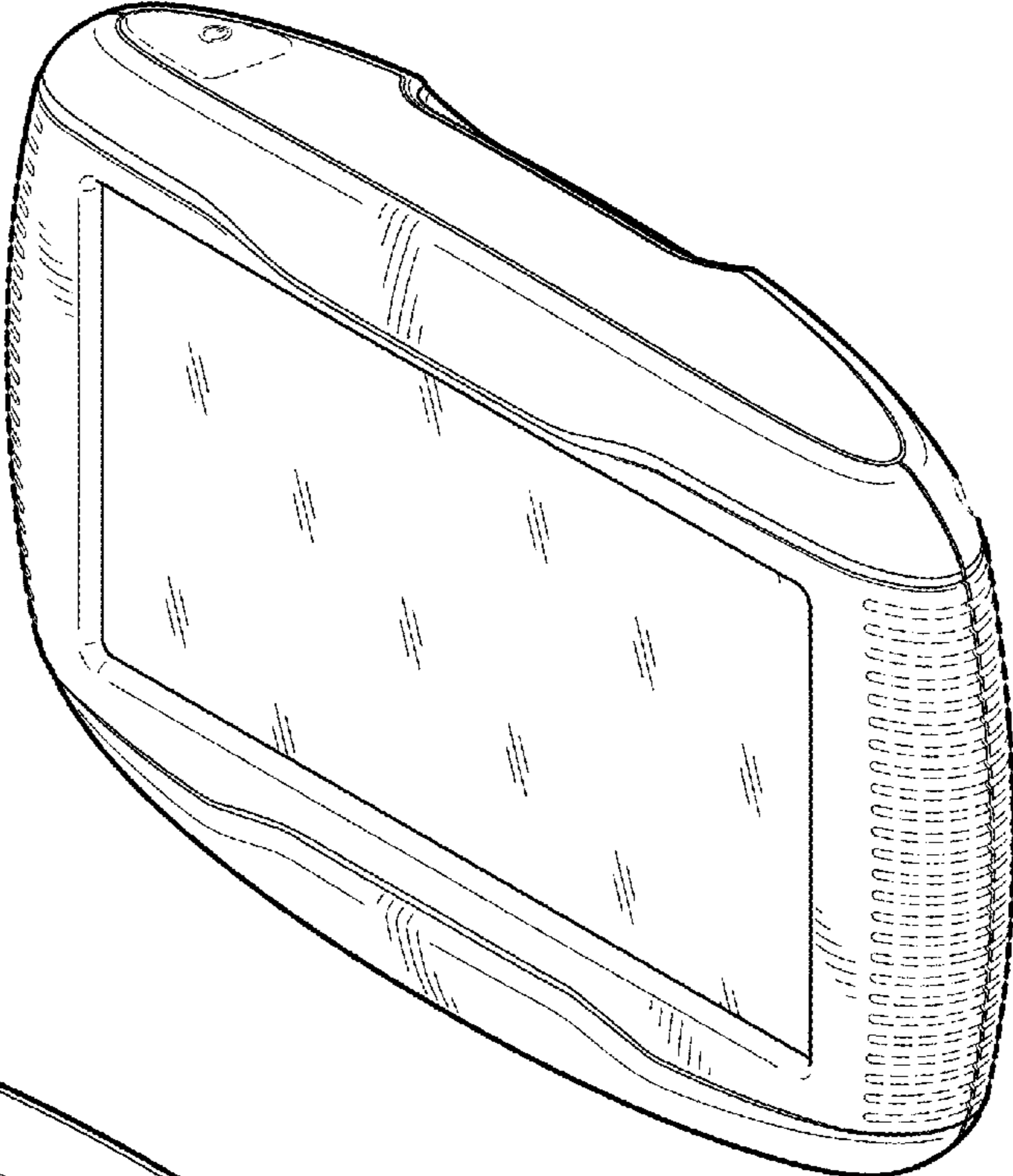

*Fig. 2*

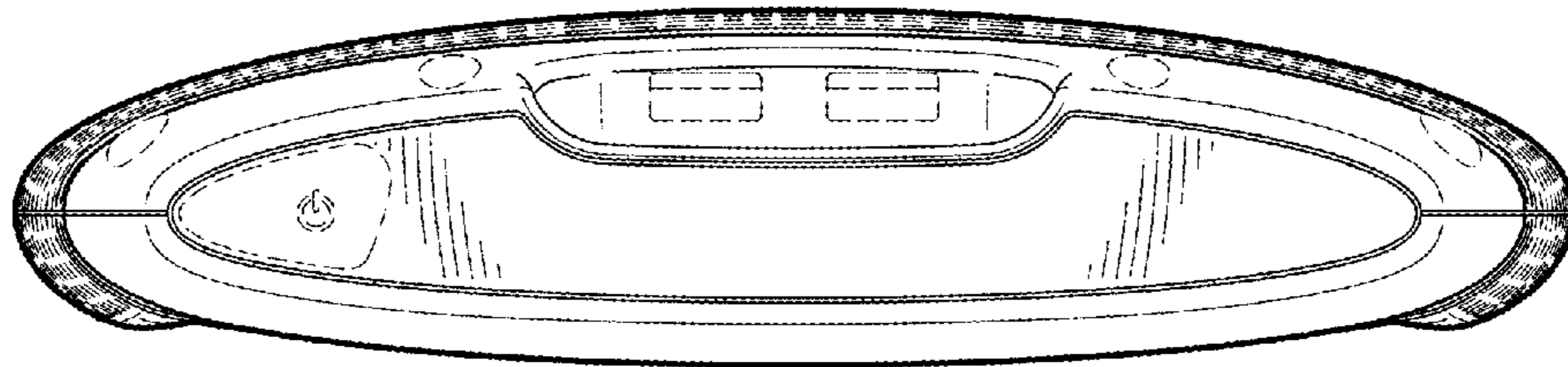

*Fig. 3*

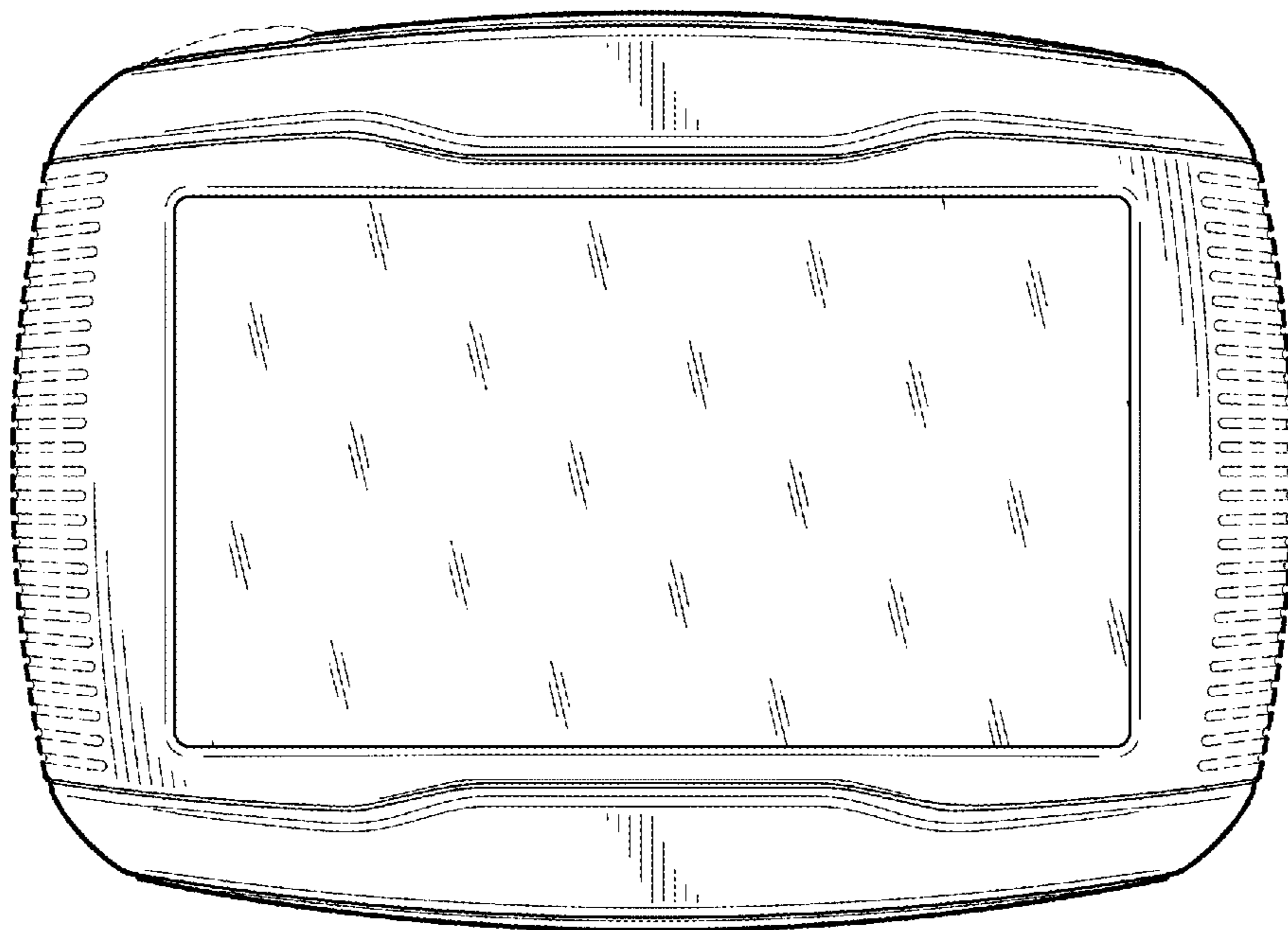

*Fig. 4*

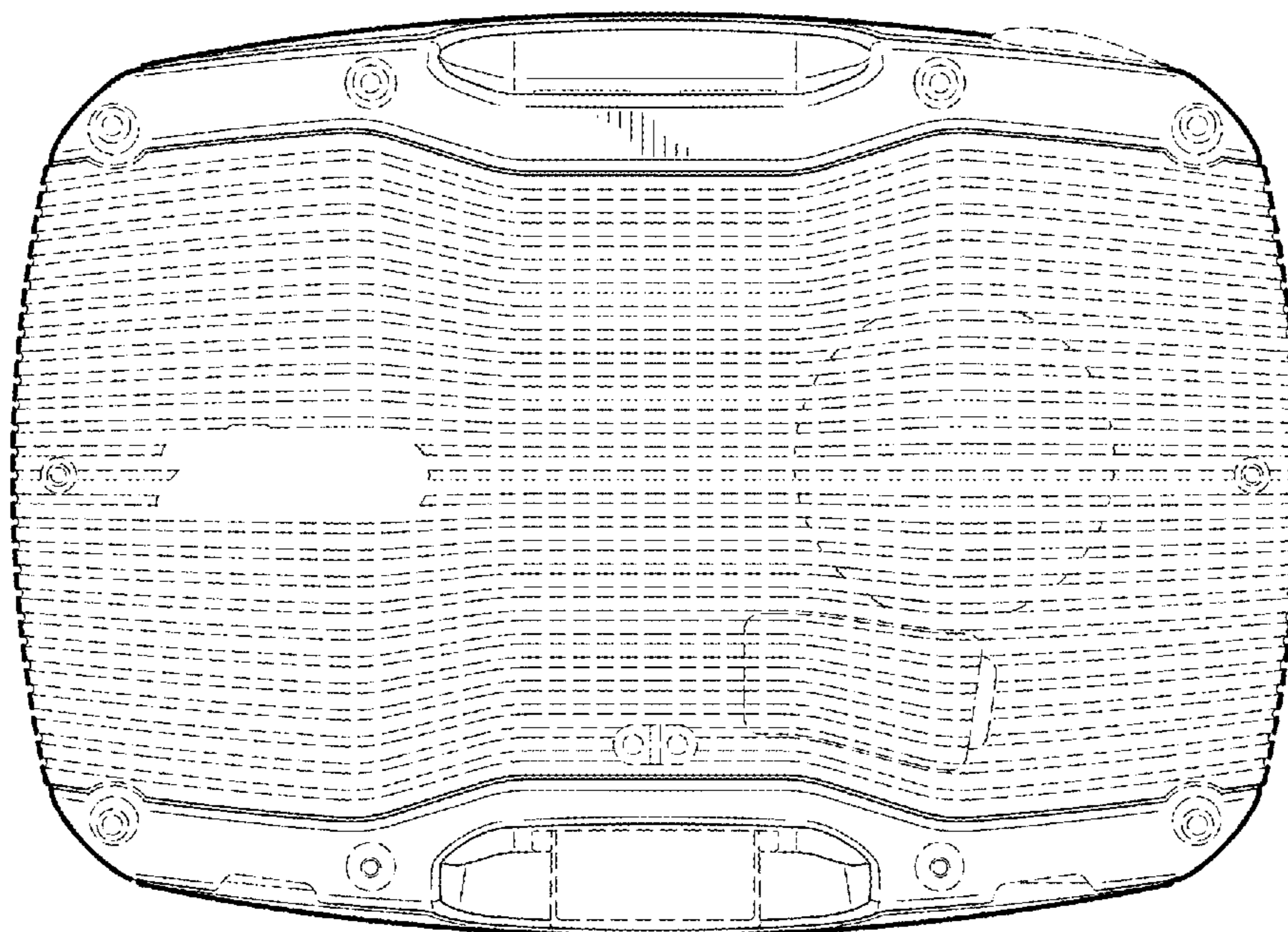

*Fig. 5*

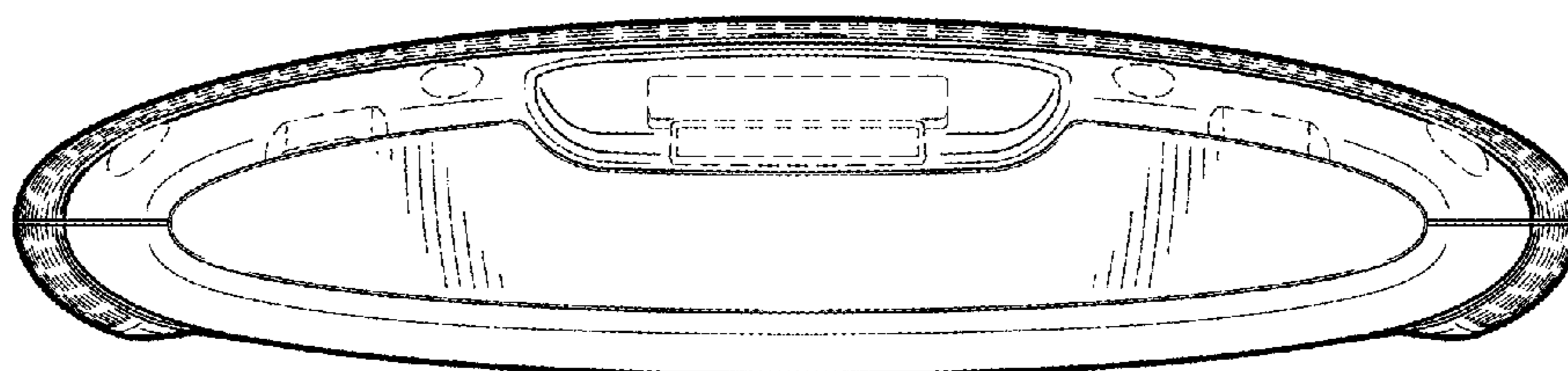

*Fig. 6*

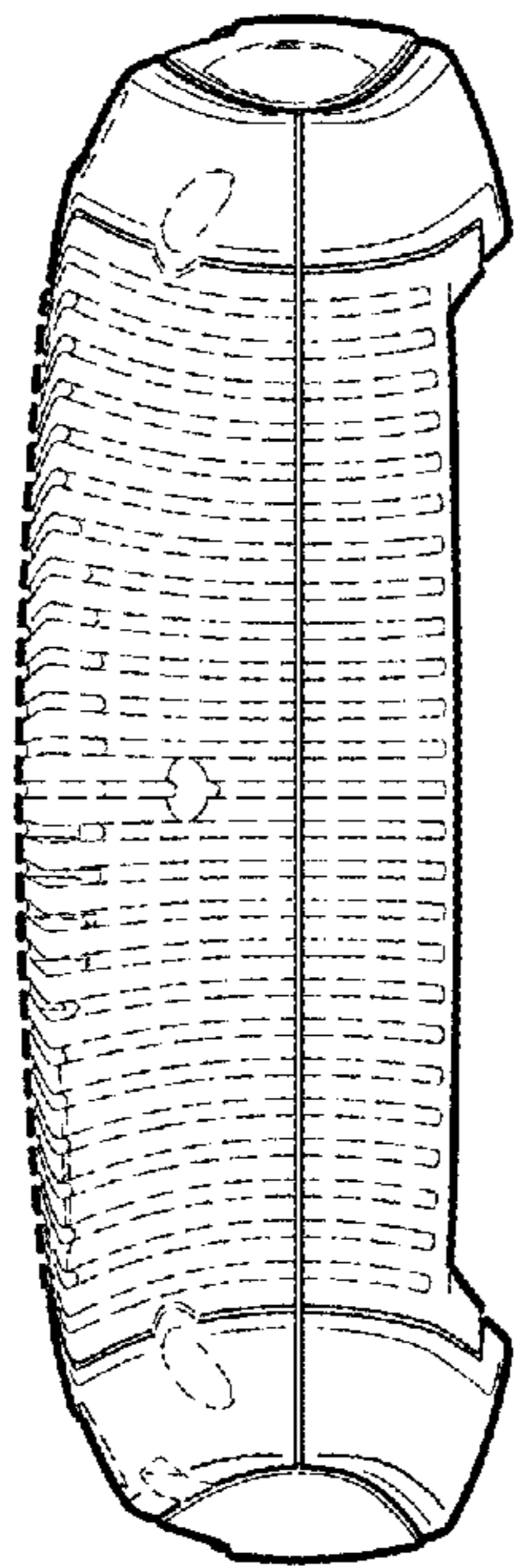

*Fig. 7*

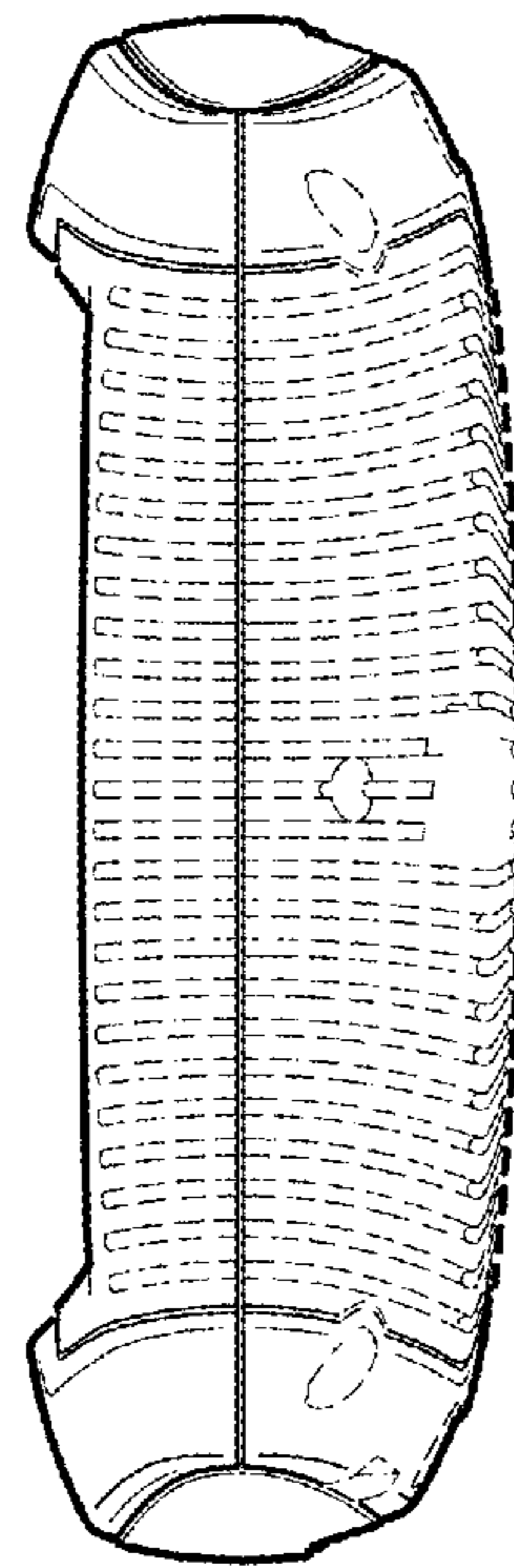

*Fig. 8*