



US00D677165S

(12) **United States Design Patent**
Kersten

(10) **Patent No.:** **US D677,165 S**
(45) **Date of Patent:** **** Mar. 5, 2013**

(54) **BOTTLE WITH HANDLE, SCREW TOP AND TRANSPARENT CAP**

(75) Inventor: **Elwin Kersten**, Eindhoven (NL)

(73) Assignee: **Reckitt Benckiser N.V.**, WT Hoofddorp (NL)

(**) Term: **14 Years**

(21) Appl. No.: **29/411,468**

(22) Filed: **Jan. 20, 2012**

(30) **Foreign Application Priority Data**

Jan. 17, 2012 (EM) 001976556-001

(51) **LOC (9) Cl.** **09-01**

(52) **U.S. Cl.** **D9/528**

(58) **Field of Classification Search** D9/434,
D9/435, 444, 445, 516, 523, 528, 530, 531,
D9/537, 538, 540, 541, 543, 552, 563, 565,
D9/572, 575; 215/381-385; 220/660, 669
See application file for complete search history.

(56) **References Cited**

U.S. PATENT DOCUMENTS

D213,822 S * 4/1969 Weekman D9/528
D231,647 S * 5/1974 Morino D9/528
D289,611 S * 5/1987 Seelig D9/528
D302,246 S * 7/1989 Ross D9/528
D302,247 S * 7/1989 Beechuk et al. D9/528
D312,571 S * 12/1990 Winger et al. D9/528

D424,946 S * 5/2000 Alsup D9/528
D459,993 S * 7/2002 Clarke et al. D9/528
D508,206 S * 8/2005 Meeker et al. D9/528
D565,415 S * 4/2008 Lablaine D9/531
D578,004 S * 10/2008 Houck et al. D9/528
D597,843 S * 8/2009 Franzolin et al. D9/531
D615,416 S * 5/2010 Lee et al. D9/543
D621,713 S * 8/2010 Wilkum et al. D9/528
D656,030 S * 3/2012 Lee et al. D9/531
D658,499 S * 5/2012 Wycoff D9/528
D663,213 S * 7/2012 Kallenbach et al. D9/528

* cited by examiner

Primary Examiner — Keli L Hill

(74) *Attorney, Agent, or Firm* — Norris McLaughlin & Marcus PA

(57) **CLAIM**

The ornamental design for a bottle with handle, screw top and transparent cap, as shown and described.

DESCRIPTION

FIG. 1 is a perspective view of our bottle with handle, screw top and transparent cap;
FIG. 2 is a left side elevational view thereof;
FIG. 3 is a right side elevational view thereof;
FIG. 4 is a front elevational view thereof;
FIG. 5 is a back elevational view thereof;
FIG. 6 is a top plan view thereof; and,
FIG. 7 is a bottom plan view thereof.

The broken lines shown are included for the purpose of illustrating the unclaimed portions of the bottle and form no part of the claim.

1 Claim, 5 Drawing Sheets

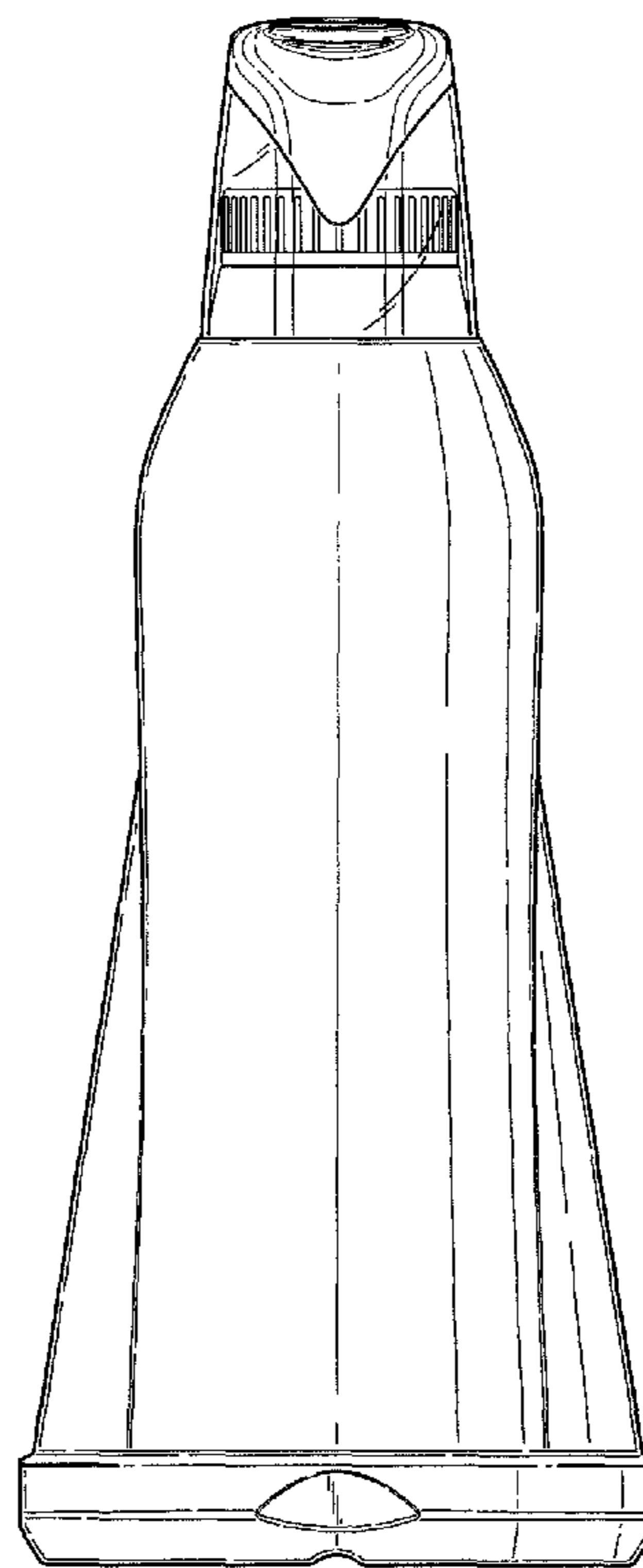
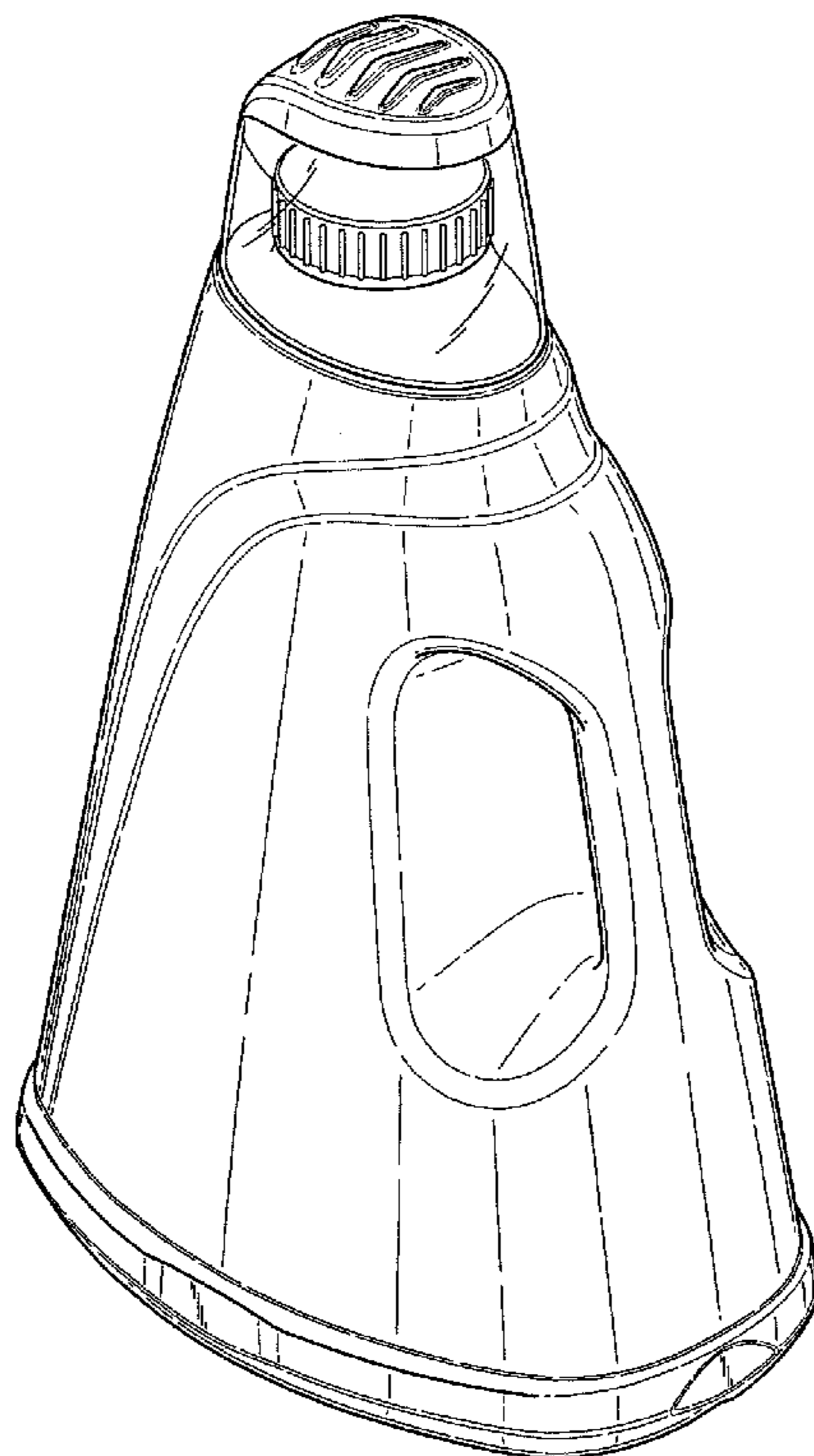

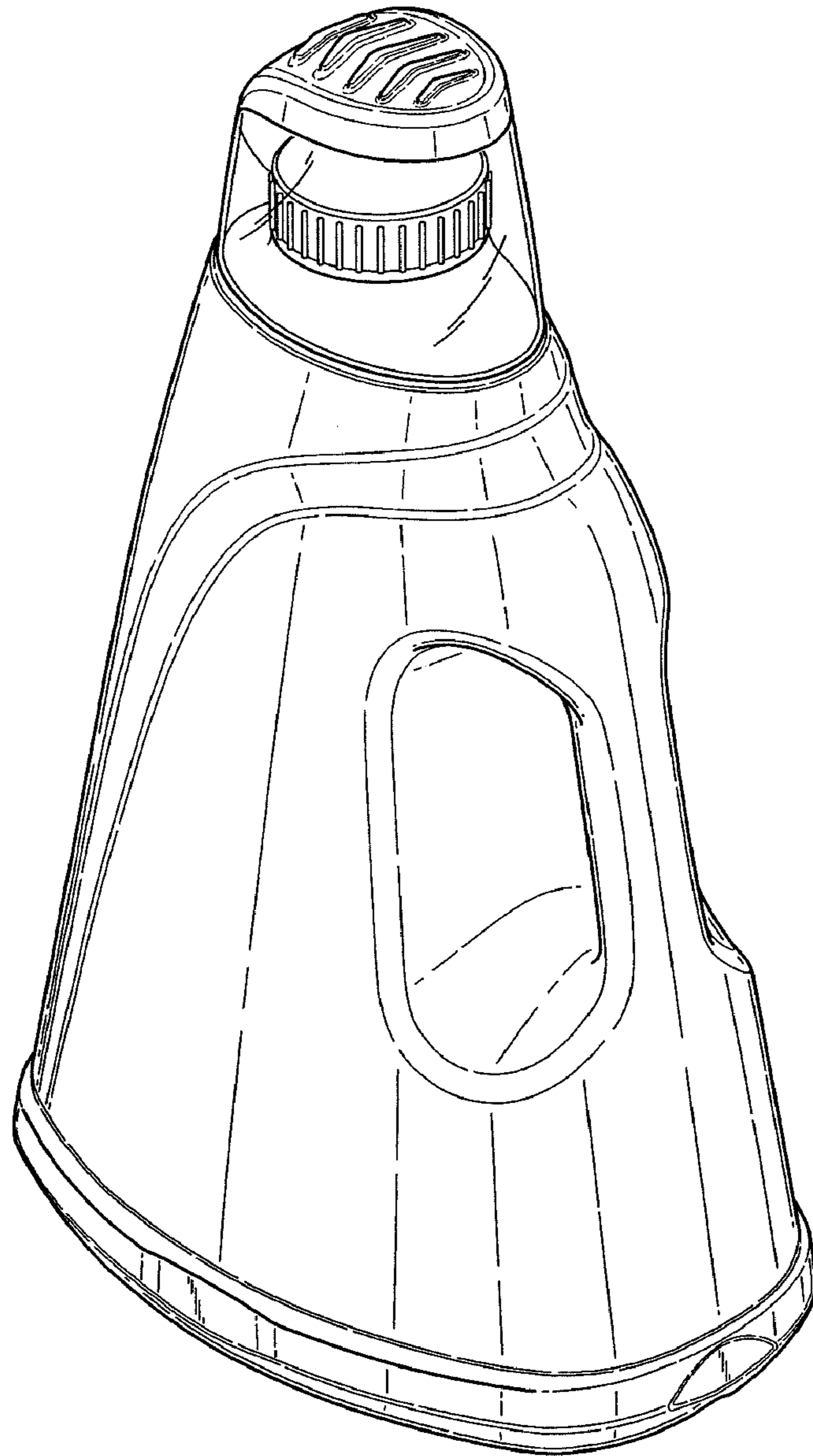

Fig. 1

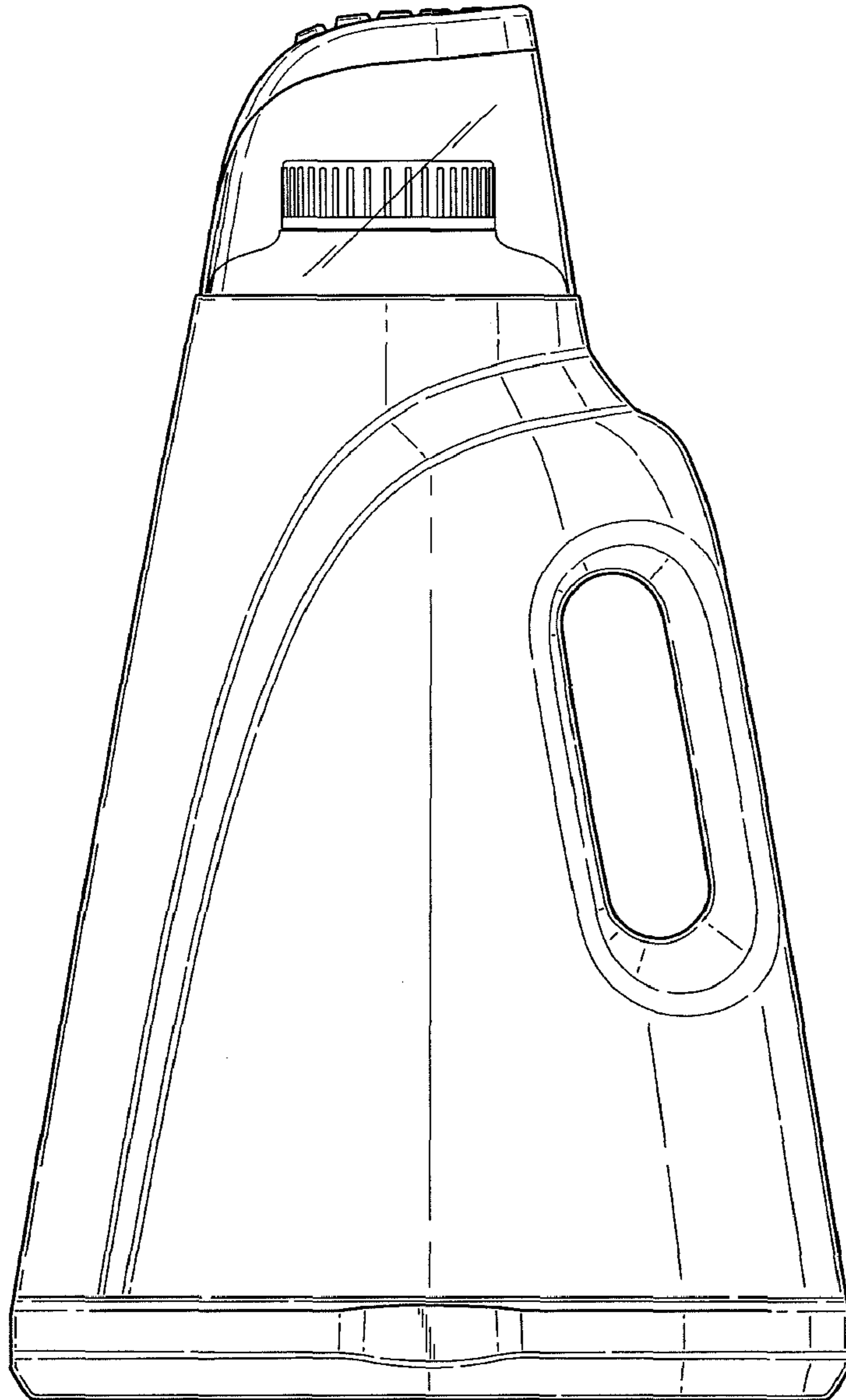

Fig. 2

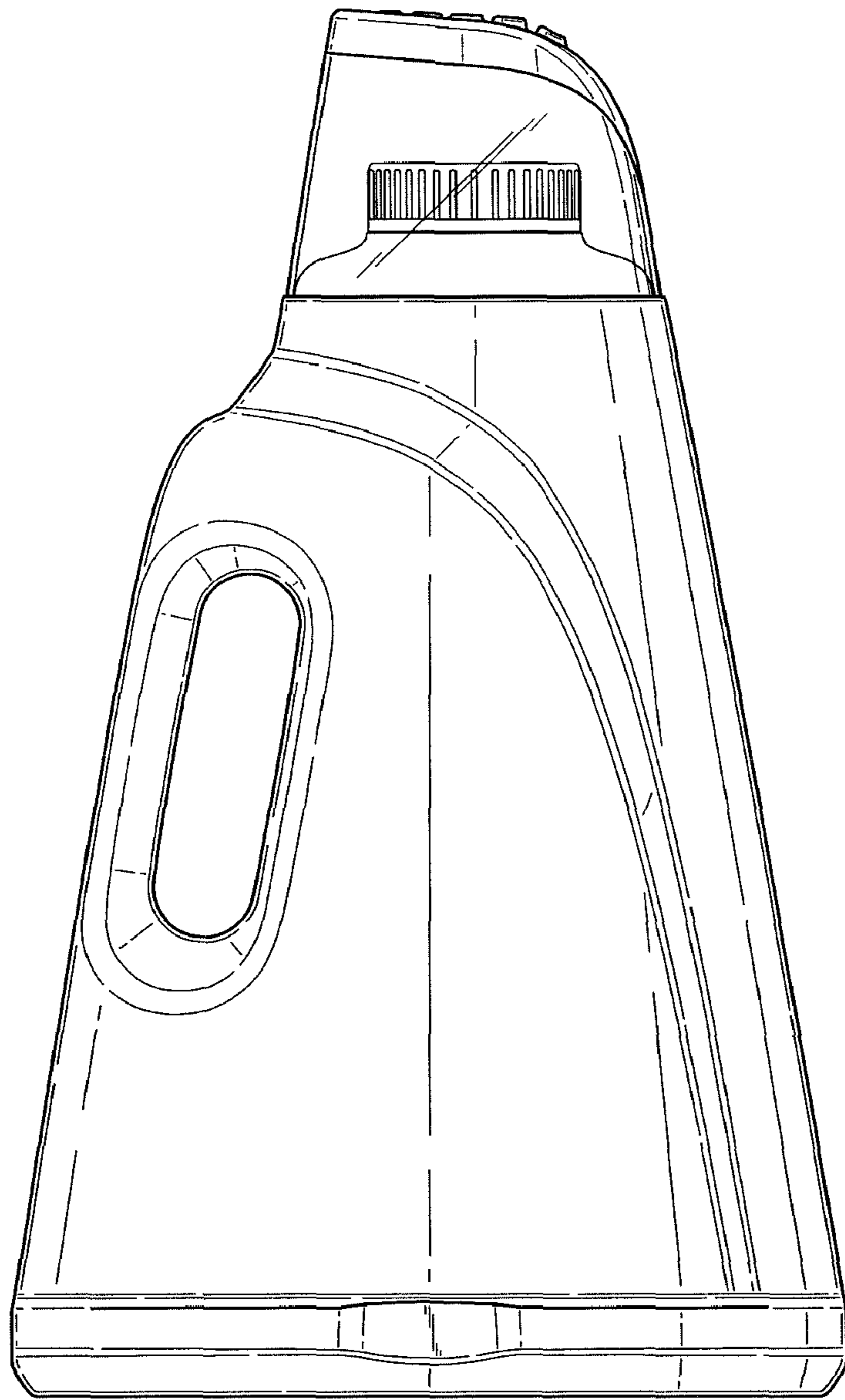

Fig. 3

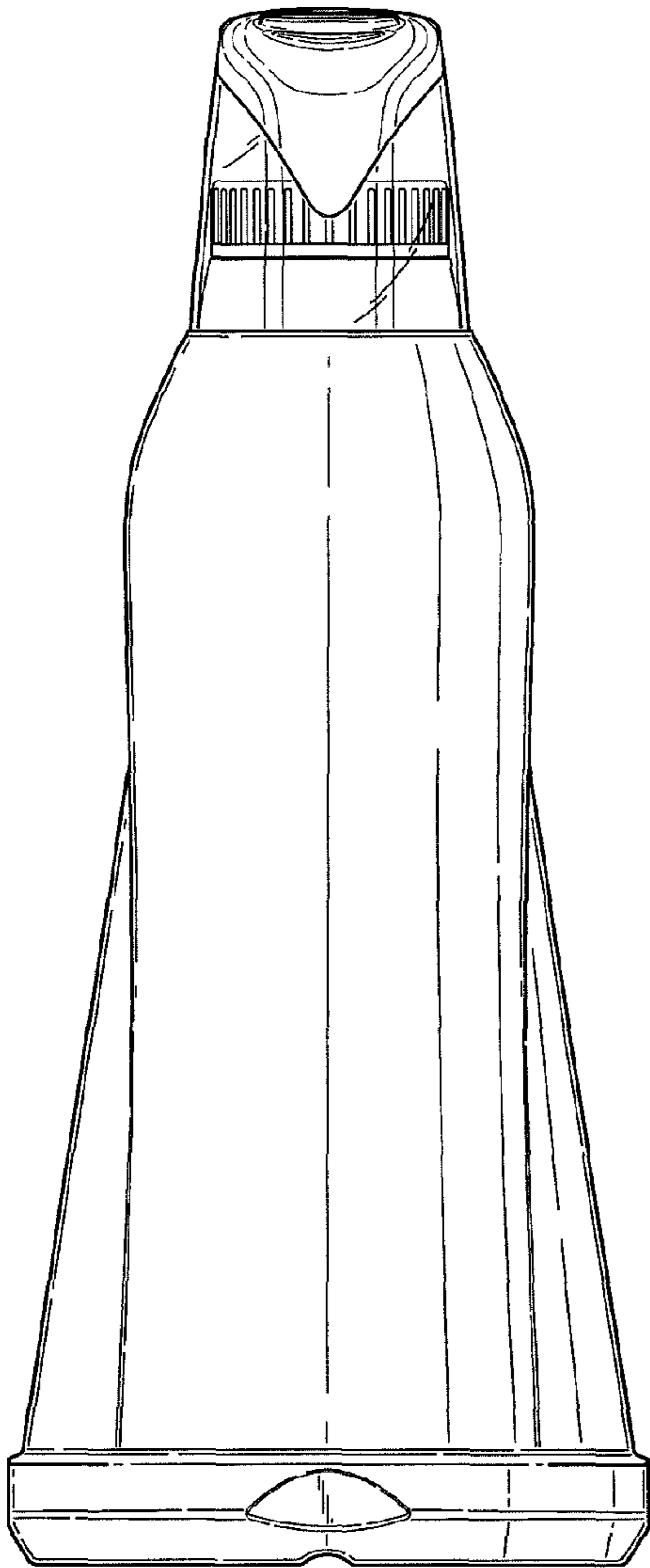

Fig. 4

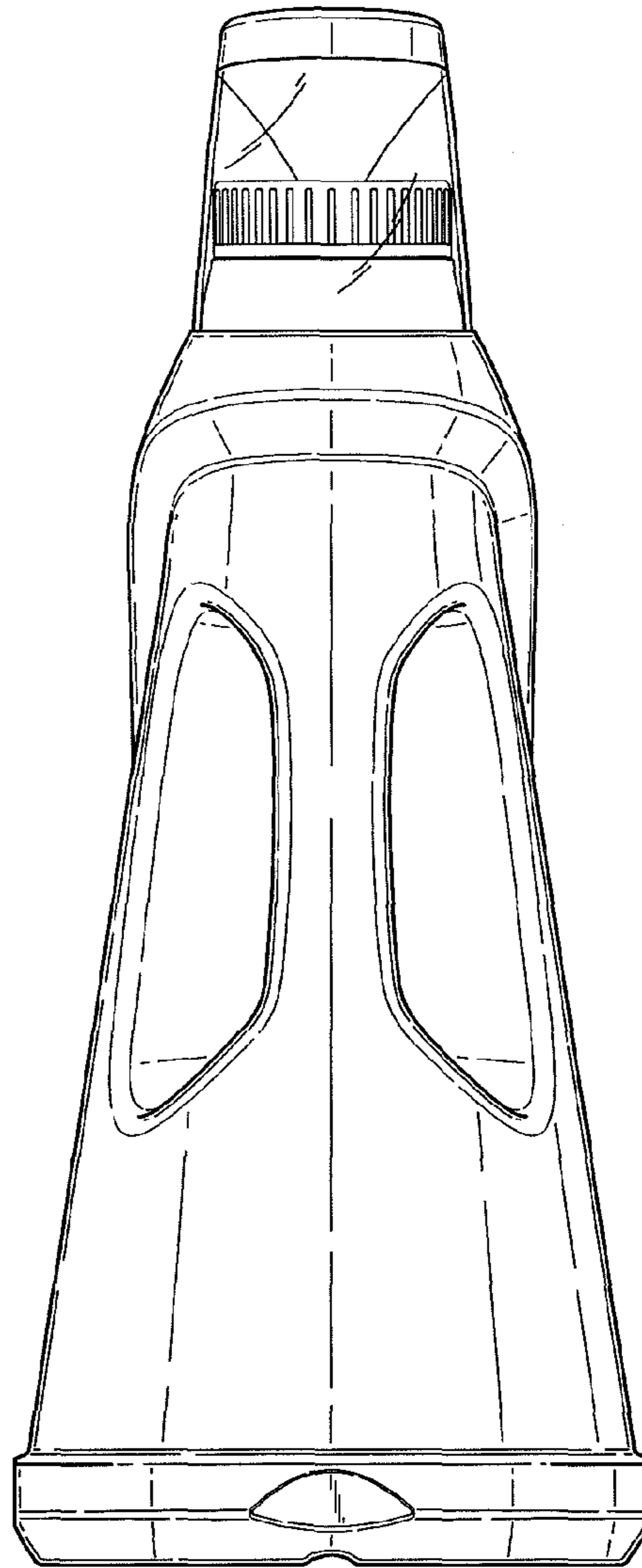

Fig. 5

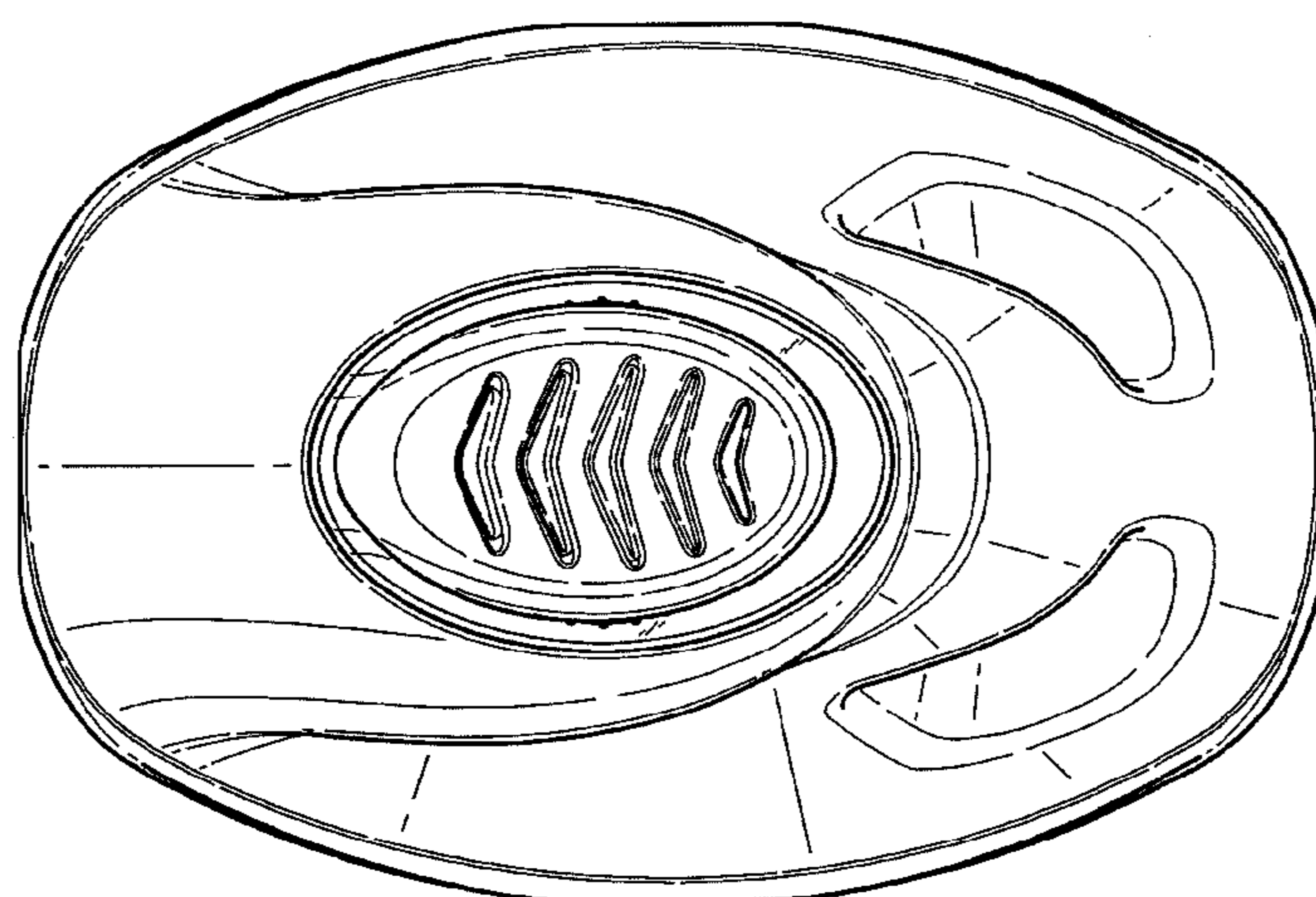

Fig. 6

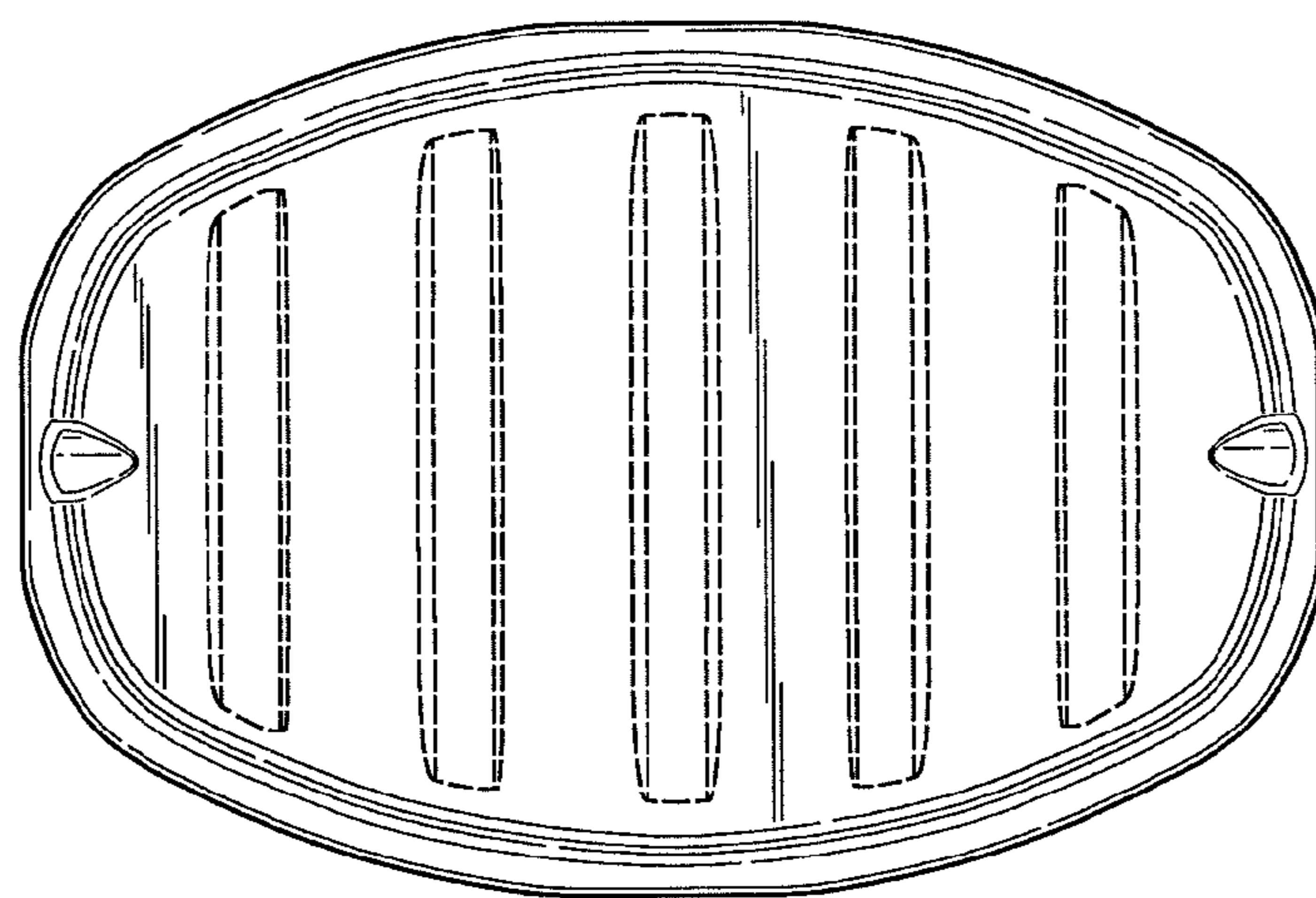

Fig. 7