



US00D677154S

(12) **United States Design Patent**
Miller et al.

(10) **Patent No.:** **US D677,154 S**
(45) **Date of Patent:** **** Mar. 5, 2013**

- (54) **TRAY**
- (75) Inventors: **Amanda Miller**, Minneapolis, MN (US);
Kent D. Katterheinrich, St. Anthony,
MN (US)
- (73) Assignee: **Target Brands, Inc.**, Minneapolis, MN
(US)
- (**) Term: **14 Years**
- (21) Appl. No.: **29/420,476**
- (22) Filed: **May 9, 2012**
- (51) **LOC (9) Cl.** **09-03**
- (52) **U.S. Cl.** **D9/424**
- (58) **Field of Classification Search** D9/414,
D9/415, 416, 423, 424, 425, 430, 431, 432,
D9/439, 440, 455, 506, 518, 522, 523, 529,
D9/530, 544, 545, 553, 564, 566, 763, 753,
D9/757, 760, 761, 764, 772, 773, 776; 206/216,
206/232, 470, 461, 463, 469, 543, 557, 771,
206/806; D7/359, 500, 514, 602, 629
See application file for complete search history.

- D380,965 S * 7/1997 Correll D9/430
- D387,623 S * 12/1997 Brooks D7/553.8
- D405,526 S * 2/1999 Bonelli D24/123
- D501,760 S * 2/2005 Bukowski D7/550.1
- D557,987 S 12/2007 Hoehne
- D578,811 S * 10/2008 Gervasi D6/511
- D600,550 S 9/2009 King
- D602,352 S 10/2009 Pendergrass et al.
- D603,255 S 11/2009 King
- D603,256 S 11/2009 King
- D605,896 S 12/2009 Zalewski et al.
- D606,665 S * 12/2009 Ahearn D24/232
- D609,509 S 2/2010 Hrovat
- D645,295 S * 9/2011 Klesath D7/354
- D665,595 S * 8/2012 Francis D6/406.3

* cited by examiner

Primary Examiner — Derrick Holland
Assistant Examiner — Lauren Calve
(74) *Attorney, Agent, or Firm* — Griffiths & Seaton PLLC

(57) **CLAIM**
The ornamental design for a tray, as shown and described.

DESCRIPTION

FIG. 1 is a front, top perspective view of a tray showing our new design;
FIG. 2 is a front view thereof;
FIG. 3 is a rear view thereof;
FIG. 4 is a right side view thereof, the left side view being a mirror image of the right side view;
FIG. 5 is a top view thereof; and,
FIG. 6 is a bottom view thereof.
The broken lines showing of a bottom rib represents unclaimed subject matter and forms no part of the claimed design.

1 Claim, 4 Drawing Sheets

- (56) **References Cited**
- U.S. PATENT DOCUMENTS
- 3,233,812 A * 2/1966 Kennedy 229/406
- D241,196 S 8/1976 Dunchock
- D251,228 S 3/1979 Block et al.
- D309,846 S * 8/1990 Pozzi D7/587
- 5,018,623 A * 5/1991 Hrenyo 206/557
- D338,595 S 8/1993 Cafarella et al.
- D338,596 S 8/1993 Cafarella et al.
- D342,806 S * 12/1993 Jones et al. D28/73
- D345,050 S * 3/1994 Ryan D12/221
- D356,254 S * 3/1995 Correll D9/423
- D380,152 S * 6/1997 Correll D9/430

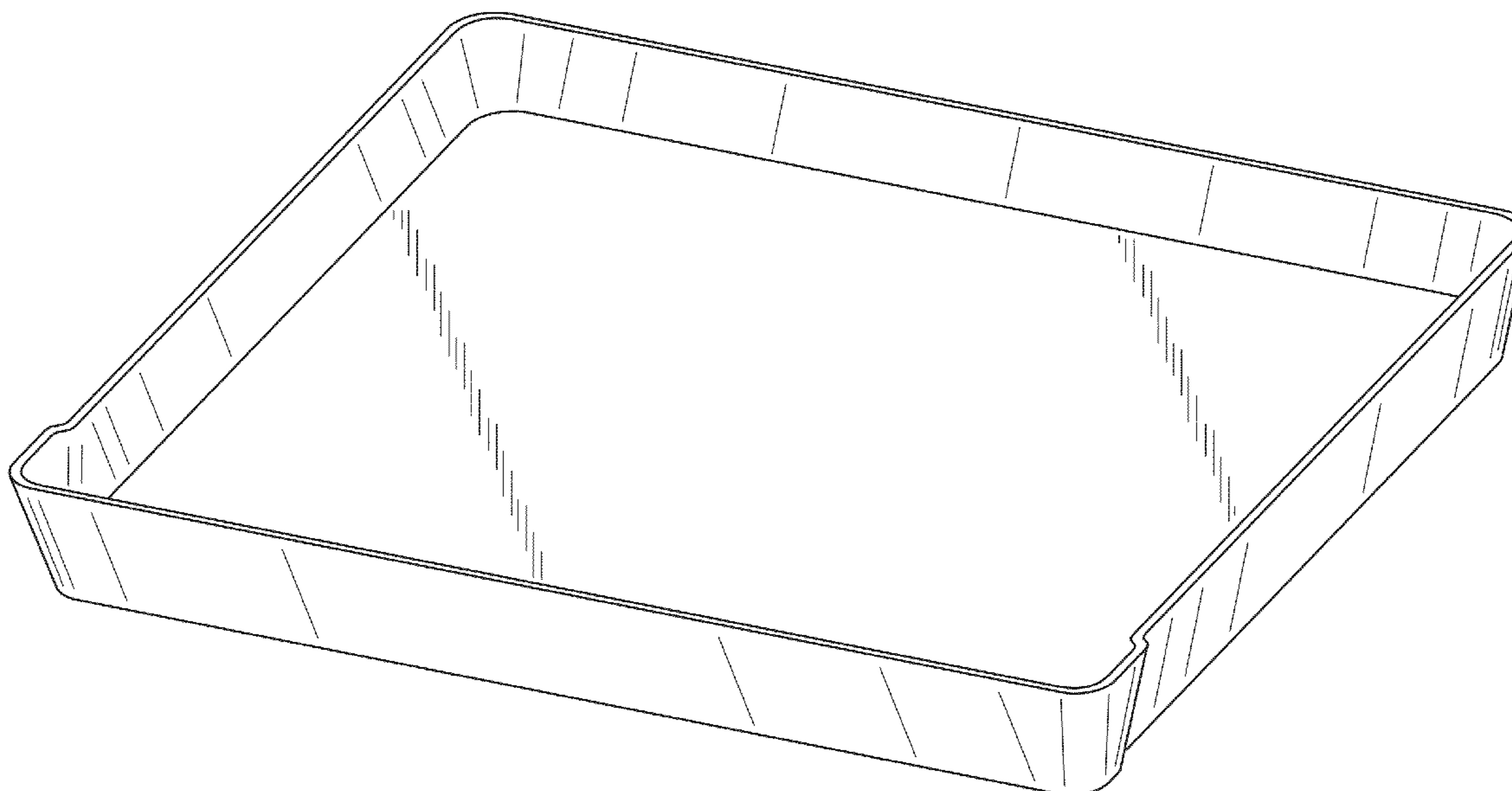

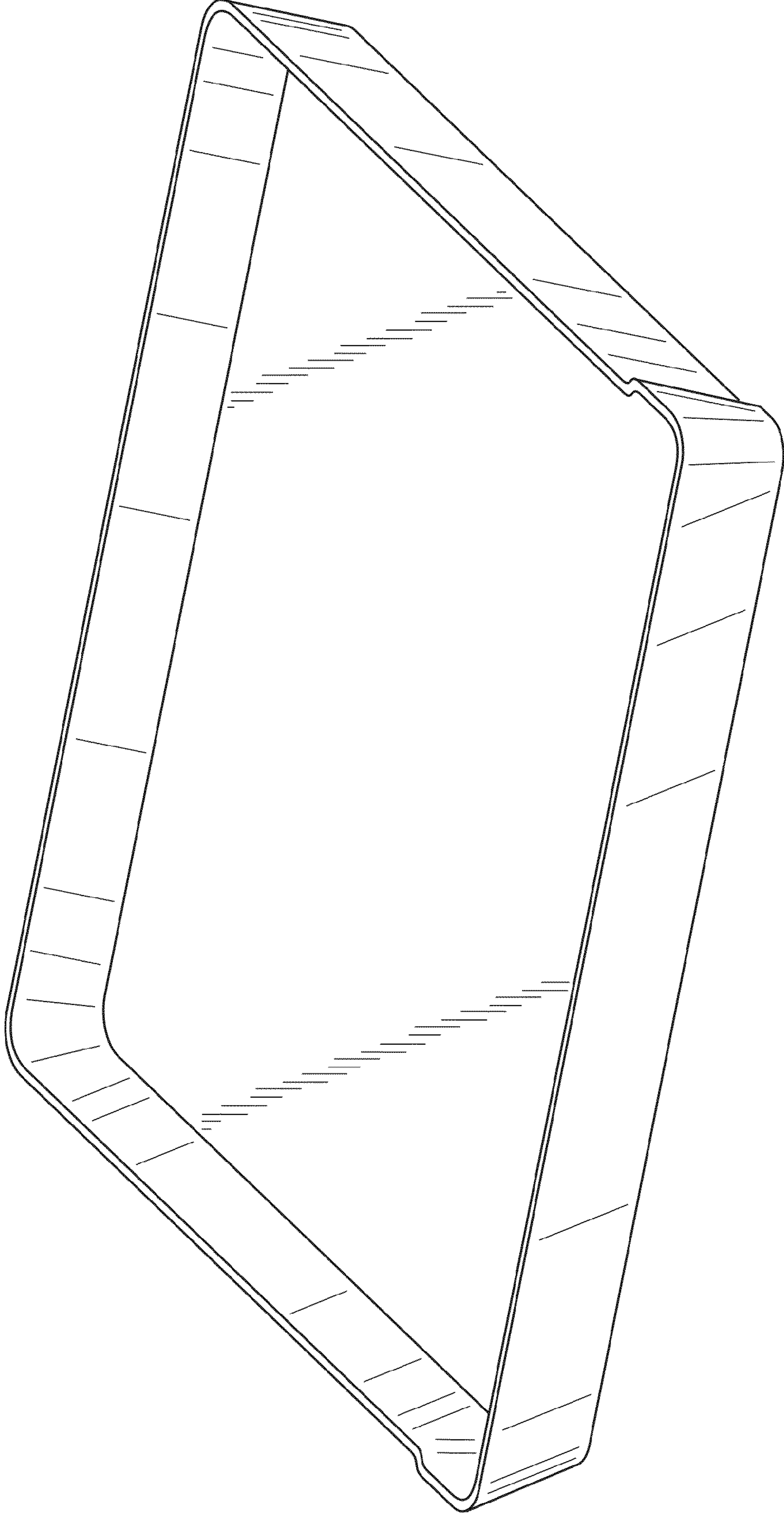

FIG. 1

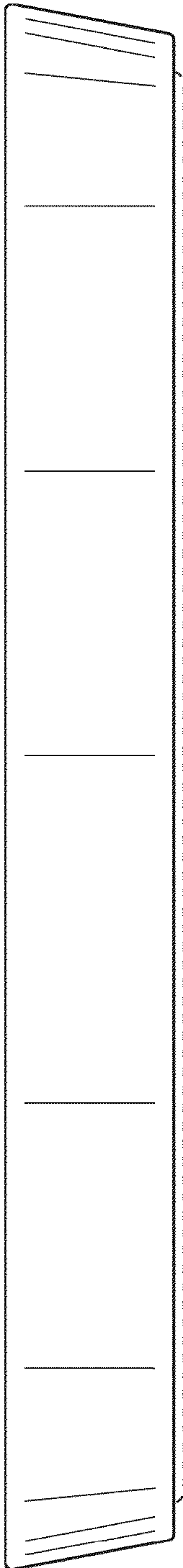

FIG. 2

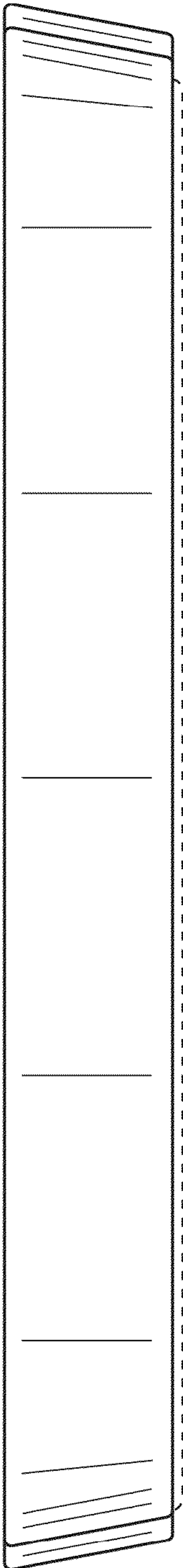

FIG. 3

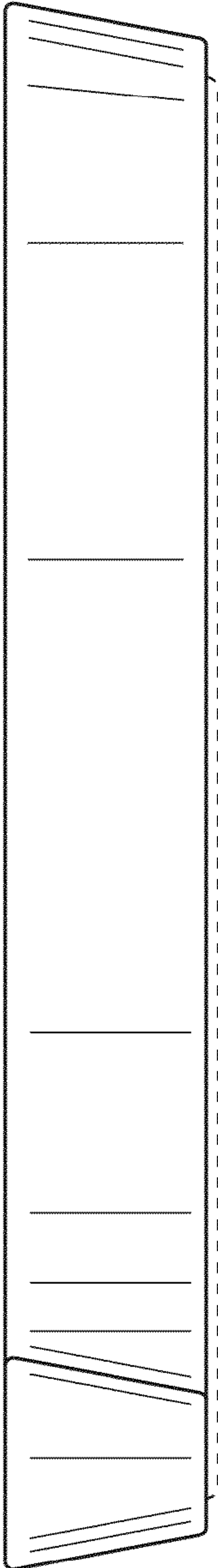

FIG. 4

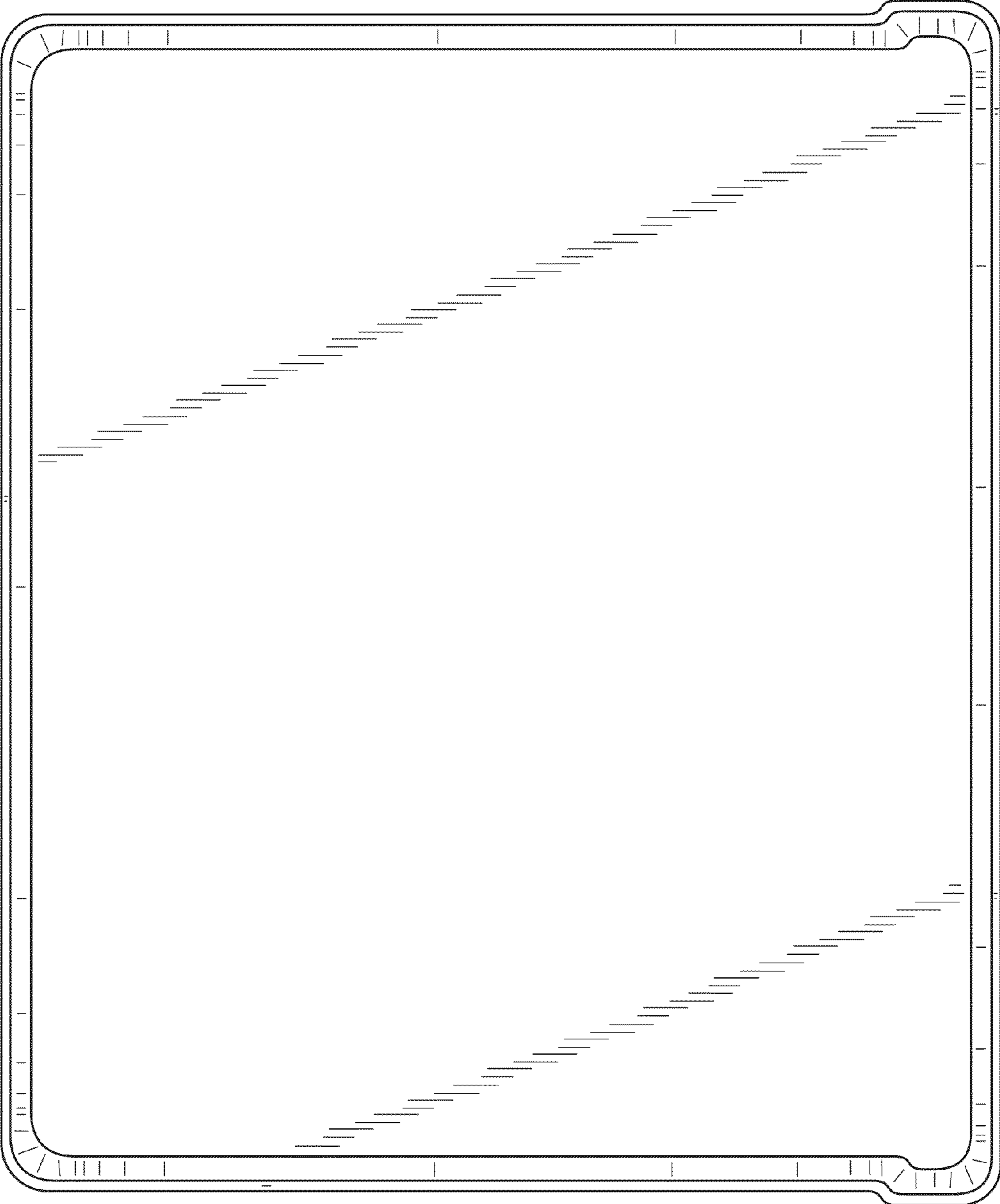

FIG. 5

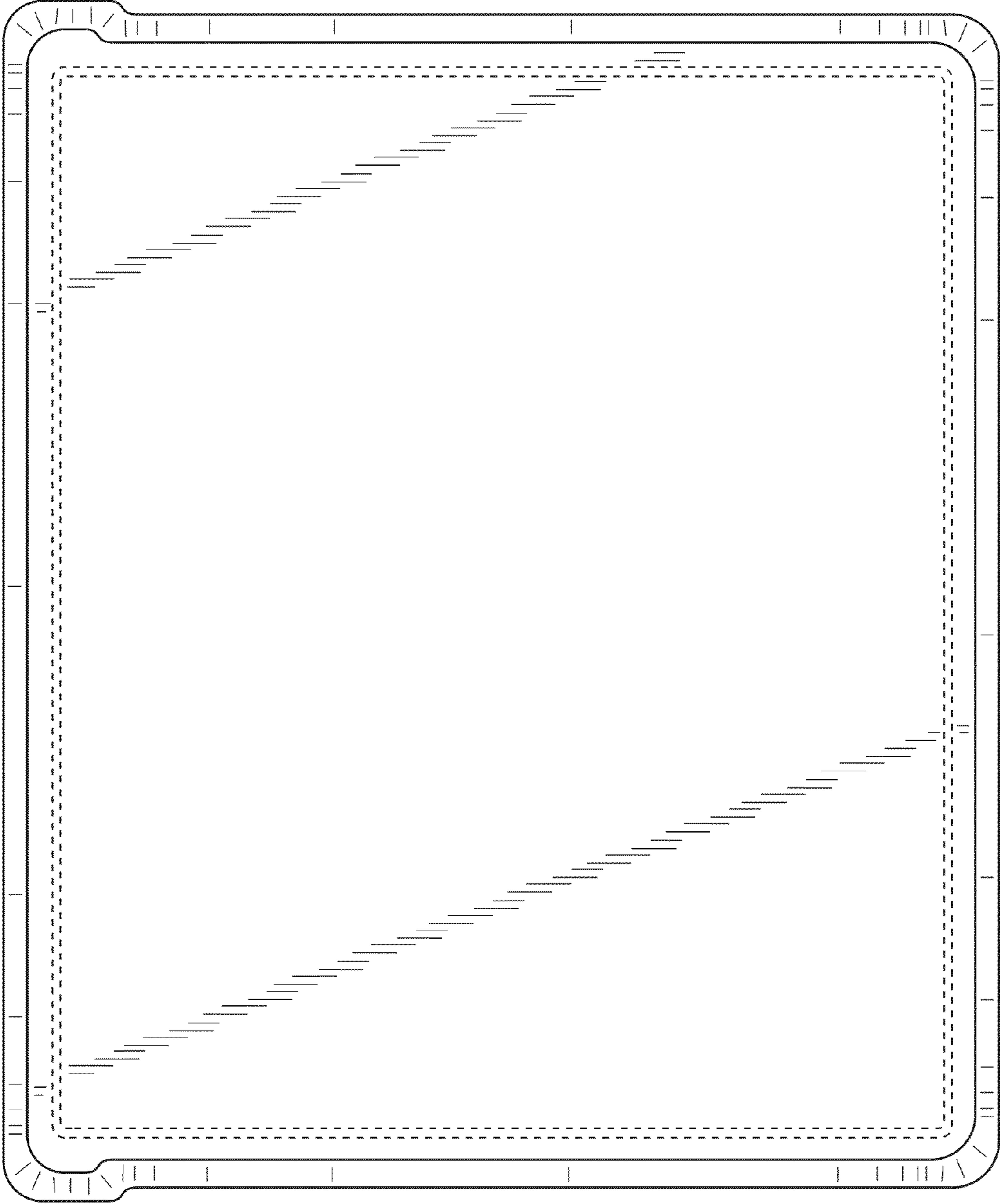

FIG. 6