



US00D677128S

(12) **United States Design Patent**
Roesser

(10) **Patent No.:** **US D677,128 S**
(45) **Date of Patent:** **** Mar. 5, 2013**

(54) **ACCESSORY FOR BEVERAGE CONTAINER**

(75) Inventor: **Allison Meredith Roesser**, Bronxville, NY (US)

(73) Assignee: **Roesser Inc.**, Bronxville, NY (US)

(**) Term: **14 Years**

(21) Appl. No.: **29/401,956**

(22) Filed: **Sep. 19, 2011**

(51) **LOC (9) Cl.** **07-06**

(52) **U.S. Cl.** **D7/625**

(58) **Field of Classification Search** D7/503,
D7/550.1, 552.2, 553.6, 554.2, 601, 602,
D7/611, 619.1, 624.1, 624.2, 625, 387, 388;
D30/129, 133; D27/102, 126, 133-135;
D11/143, 152; 220/592.16, 592.17, 737-739,
220/902, 903; 215/392, 393, 394, 395; 248/311.2,
248/346.01, 346.11; 211/71.01, 74

See application file for complete search history.

(56) **References Cited**

U.S. PATENT DOCUMENTS

2,063,328	A	12/1936	Morcom	
2,689,469	A	9/1954	Happe et al.	
D175,527	S *	9/1955	Anson	D7/624.1
2,727,645	A *	12/1955	Dore	215/393
2,905,351	A	9/1959	Lerner	
3,023,702	A	4/1962	St. Cyr	
3,161,394	A *	12/1964	Savitt	215/394
3,297,289	A	1/1967	La Raus	
3,606,074	A *	9/1971	Hayes	220/212
3,632,015	A	1/1972	Barth	
D226,215	S *	1/1973	Hillis	D7/624.1
D230,929	S *	3/1974	Wang	D7/625
3,831,209	A	8/1974	Clingman	
D245,662	S *	9/1977	Hall	D7/624.1
4,336,574	A *	6/1982	Goodman	362/101
4,726,553	A	2/1988	Wischusen, III	
4,889,302	A	12/1989	Tucker	
D309,841	S *	8/1990	Fox	D7/624.1
D311,477	S	10/1990	Fallgatter et al.	
D312,028	S *	11/1990	Pinette, Jr.	D7/624.1

D312,191	S *	11/1990	Pinette, Jr.	D7/624.1
D316,014	S *	4/1991	Pinette, Jr.	D7/624.1
D316,501	S *	4/1991	Pinette, Jr.	D7/624.1
5,143,247	A	9/1992	Gavle	
D333,265	S *	2/1993	Lindsey	D9/455
5,310,072	A	5/1994	Matusovsky et al.	
D348,183	S *	6/1994	Sawatsky et al.	D7/624.1
5,447,764	A	9/1995	Langford	
D364,776	S *	12/1995	Gerke	D7/624.1
D375,659	S *	11/1996	Lipic	D7/624.1
D383,271	S	9/1997	Eshelman	
5,984,136	A	11/1999	Mason	
D421,697	S *	3/2000	Hollinger	D7/624.1
D422,119	S *	3/2000	Austin	D28/73
D424,443	S *	5/2000	Panetti	D9/455
D428,776	S *	8/2000	Shuman	D7/624.1
6,571,976	B1	6/2003	Sonnabend	
D494,423	S *	8/2004	Wright	D7/606

(Continued)

FOREIGN PATENT DOCUMENTS

JP 2-282051 11/1990

OTHER PUBLICATIONS

“No Tip Cup Keeper” Allegro Medical—<http://www.allegromedical.com/daily-living-aids-c519/no-tip-cop-keeper-p192860.html>, printed on Dec. 5, 2012.

Primary Examiner — Elizabeth J Oswecki

(74) *Attorney, Agent, or Firm* — Kramer & Amado P.C.

(57) **CLAIM**

The ornamental design for an accessory for a beverage container, as shown and described.

DESCRIPTION

FIG. 1 is a perspective view of an accessory for a beverage container showing my new design;

FIG. 2 is a side view thereof;

FIG. 3 is a top view thereof;

FIG. 4 is a cross-sectional side view thereof taken along line 4-4 of FIG. 2; and,

FIG. 5 is a bottom view thereof.

1 Claim, 3 Drawing Sheets

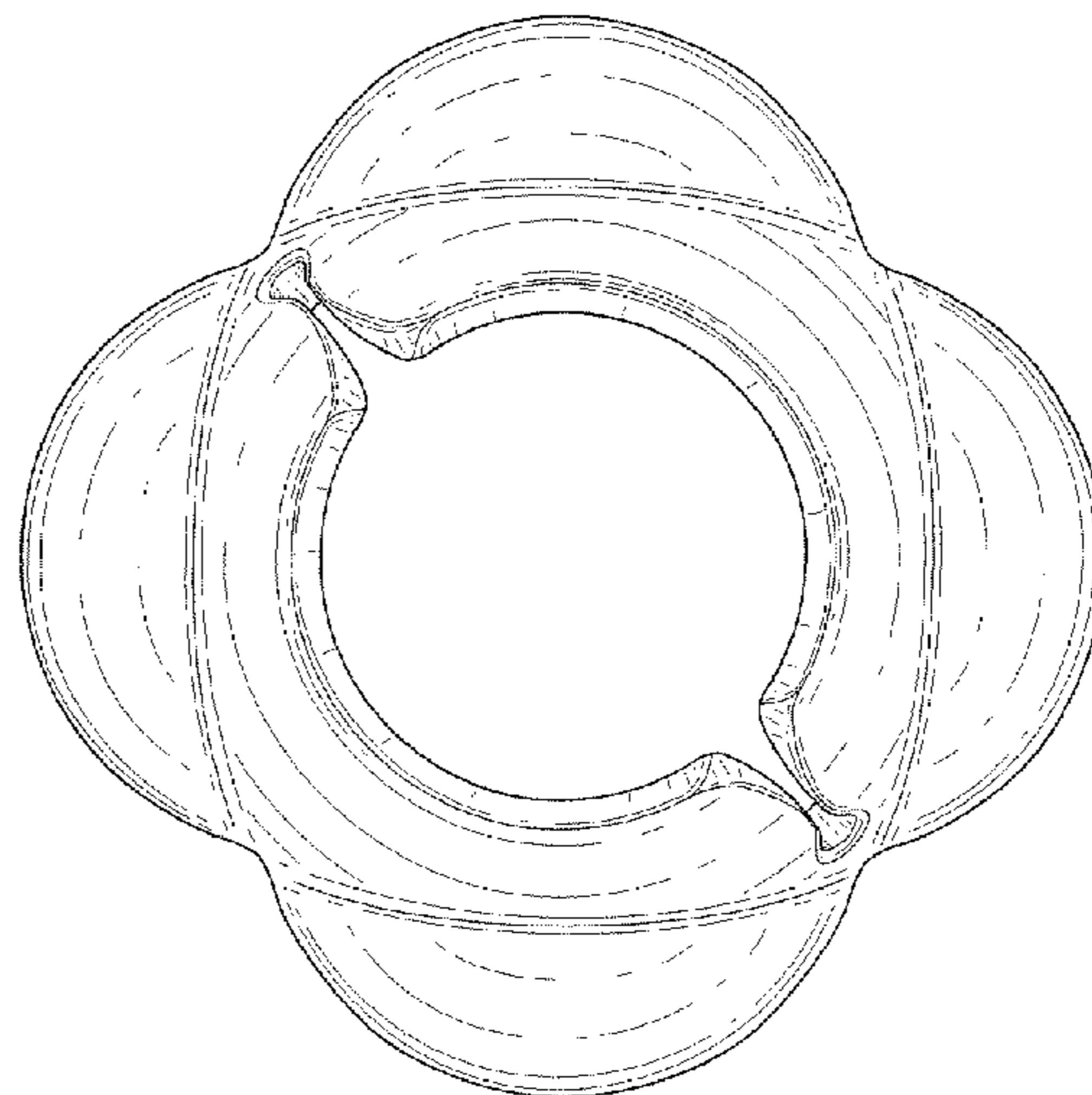
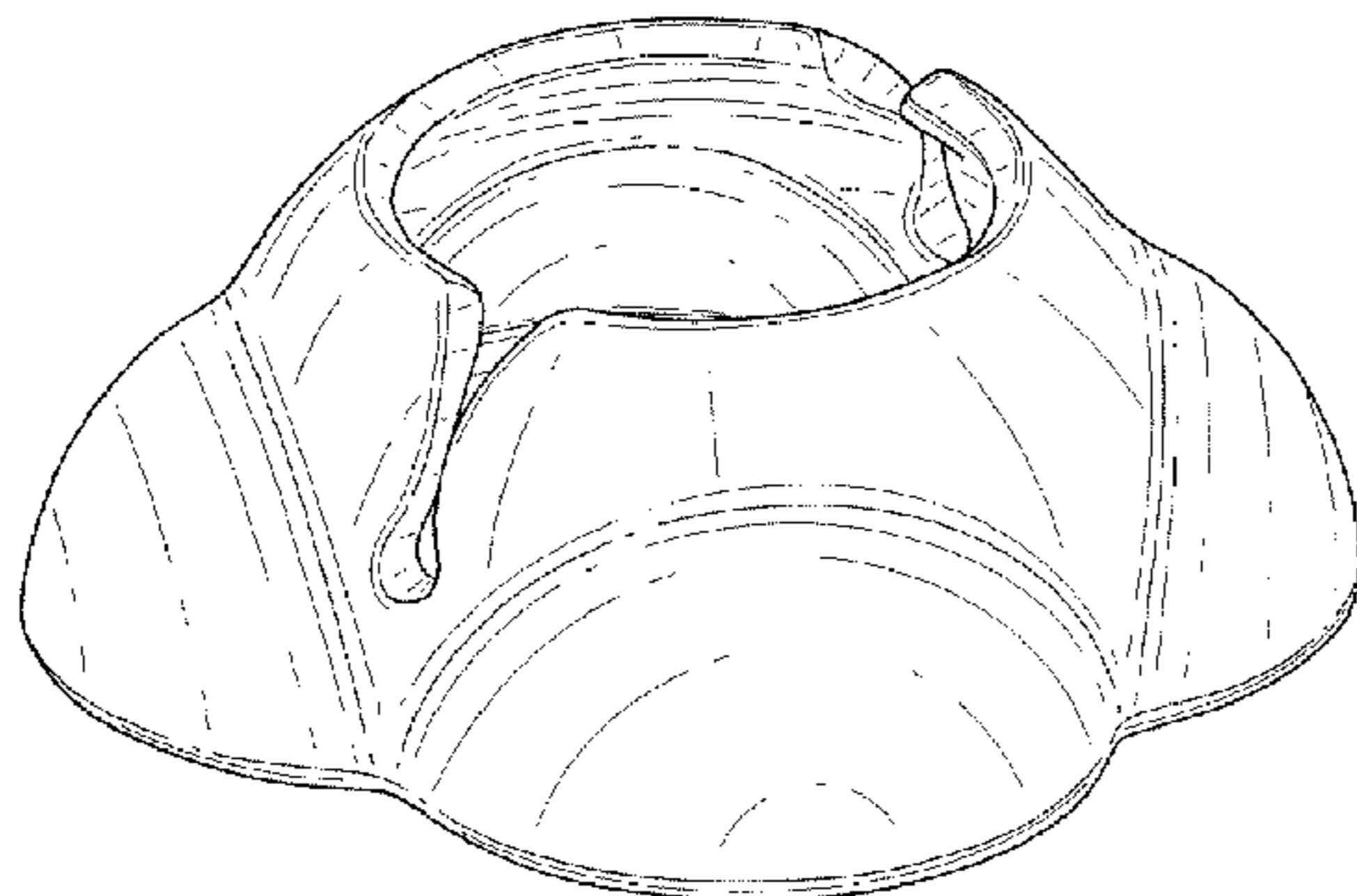

US D677,128 S

Page 2

U.S. PATENT DOCUMENTS

D535,520 S *	1/2007	Cundieff	D7/396.6	D653,088 S *	1/2012	Hansen et al.	D7/624.1
D575,581 S *	8/2008	Harris	D7/396.6	D653,914 S *	2/2012	Lutz	D7/624.1
D592,371 S	5/2009	Dellinger		D660,654 S *	5/2012	Radinsky	D7/624.1
7,556,230 B2	7/2009	Sarullo		2007/0205205 A1	9/2007	Kliewer	
7,628,290 B2	12/2009	Dagdagan		2008/0190948 A1	8/2008	Sayasithsena	
D607,699 S *	1/2010	Wikstrom	D7/624.1	2010/0102073 A1	4/2010	Henrie	
7,726,621 B1	6/2010	Dellinger					

* cited by examiner

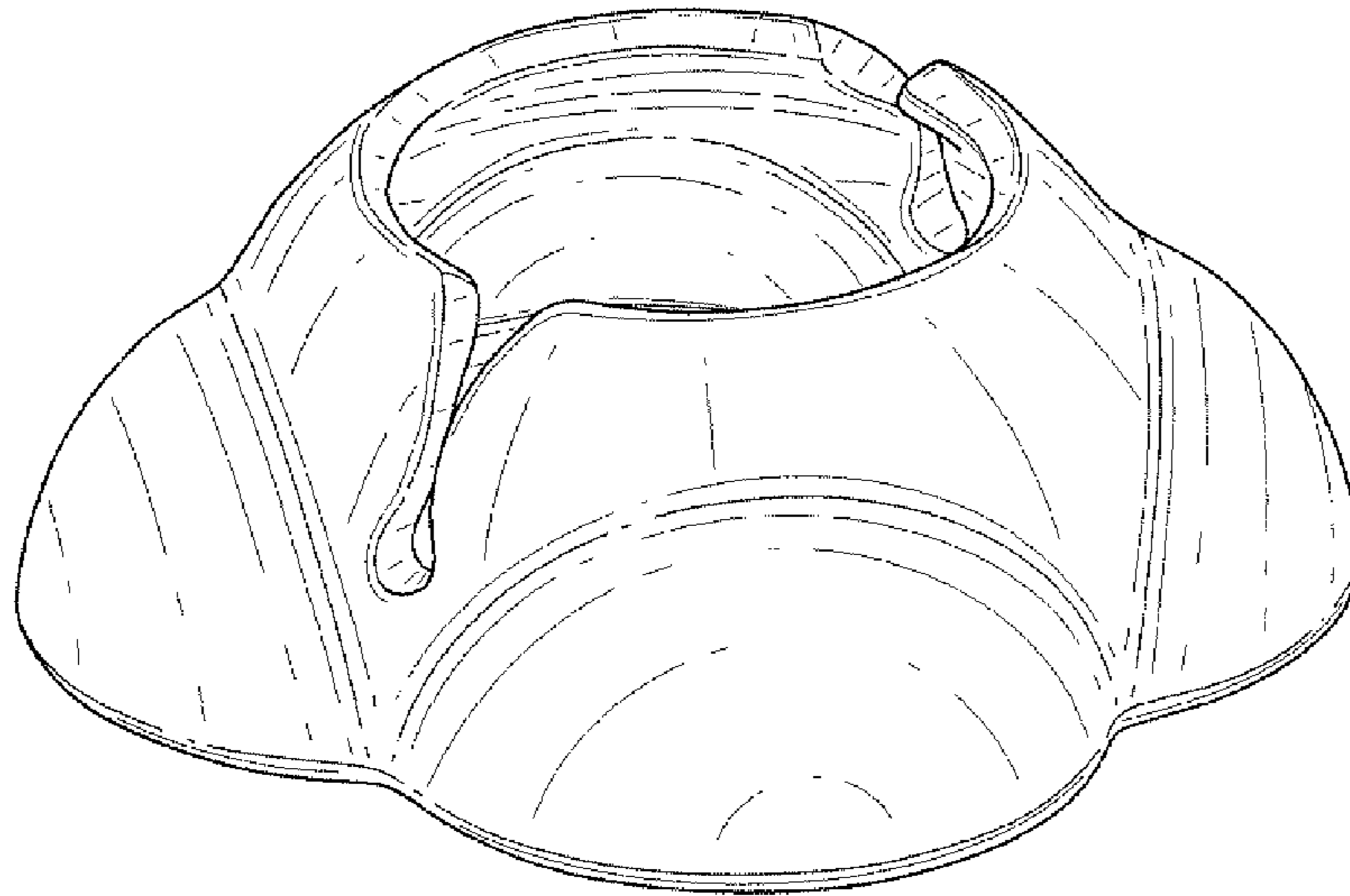

FIG. 1

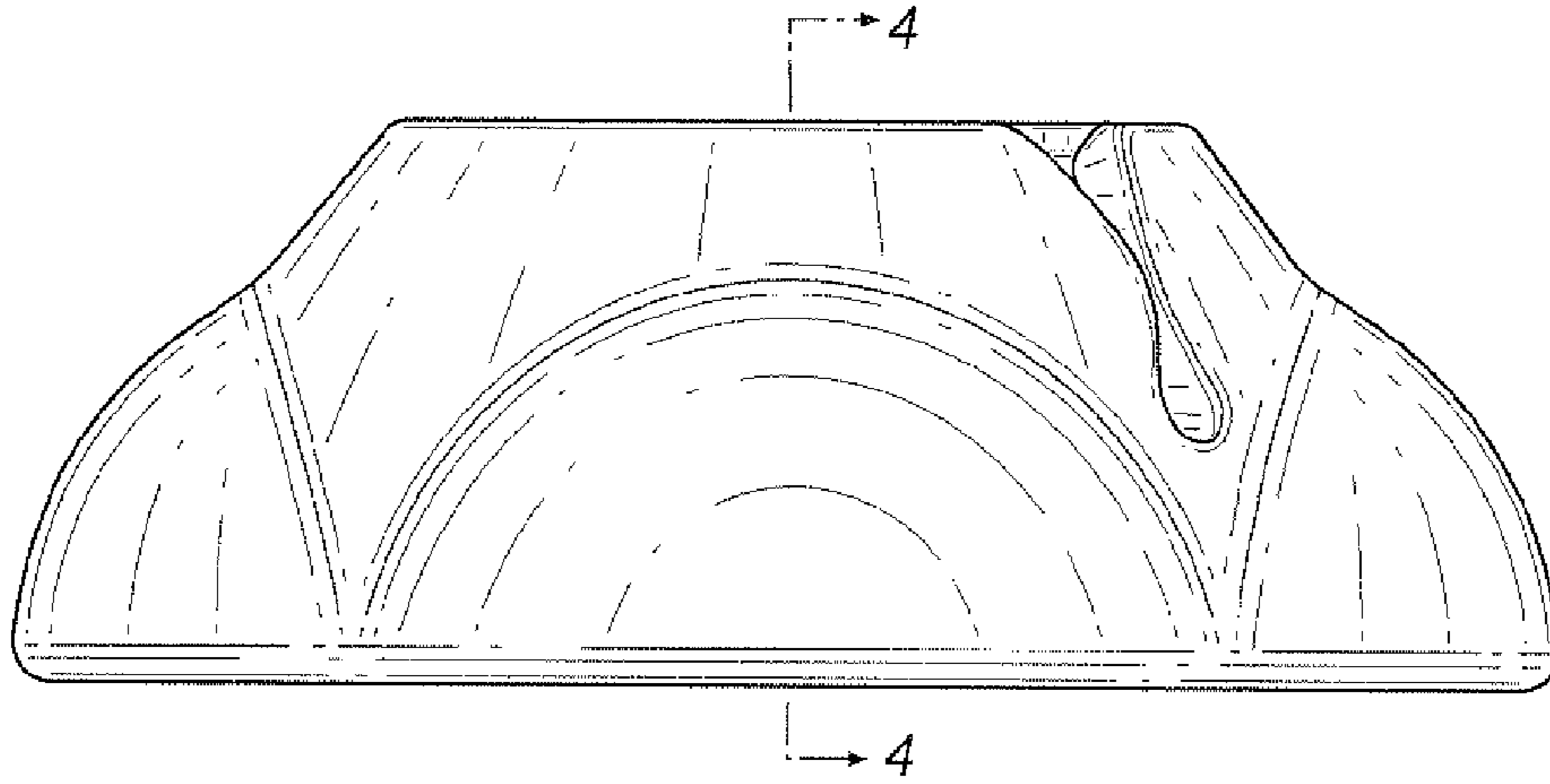

FIG. 2

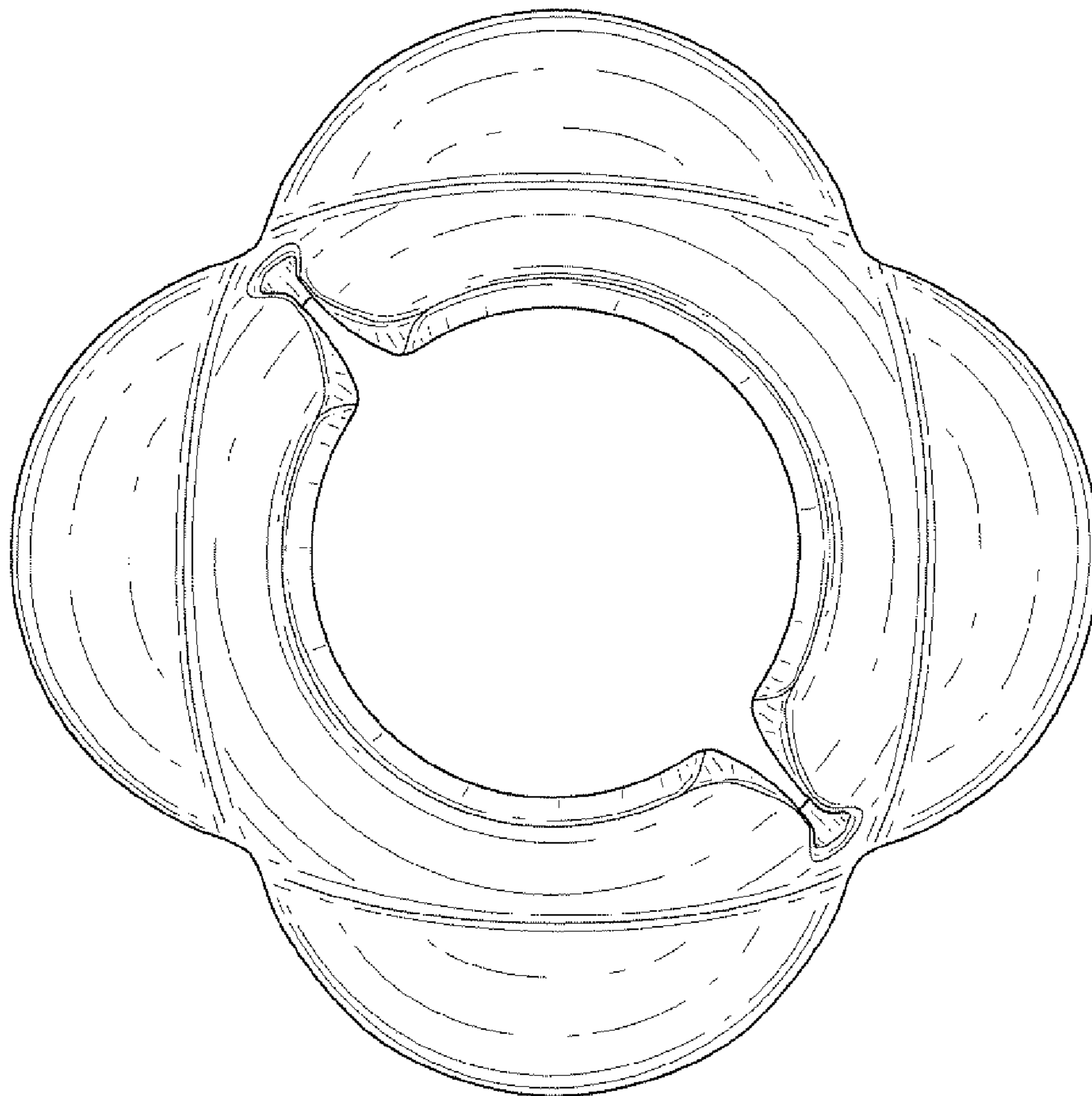

FIG. 3

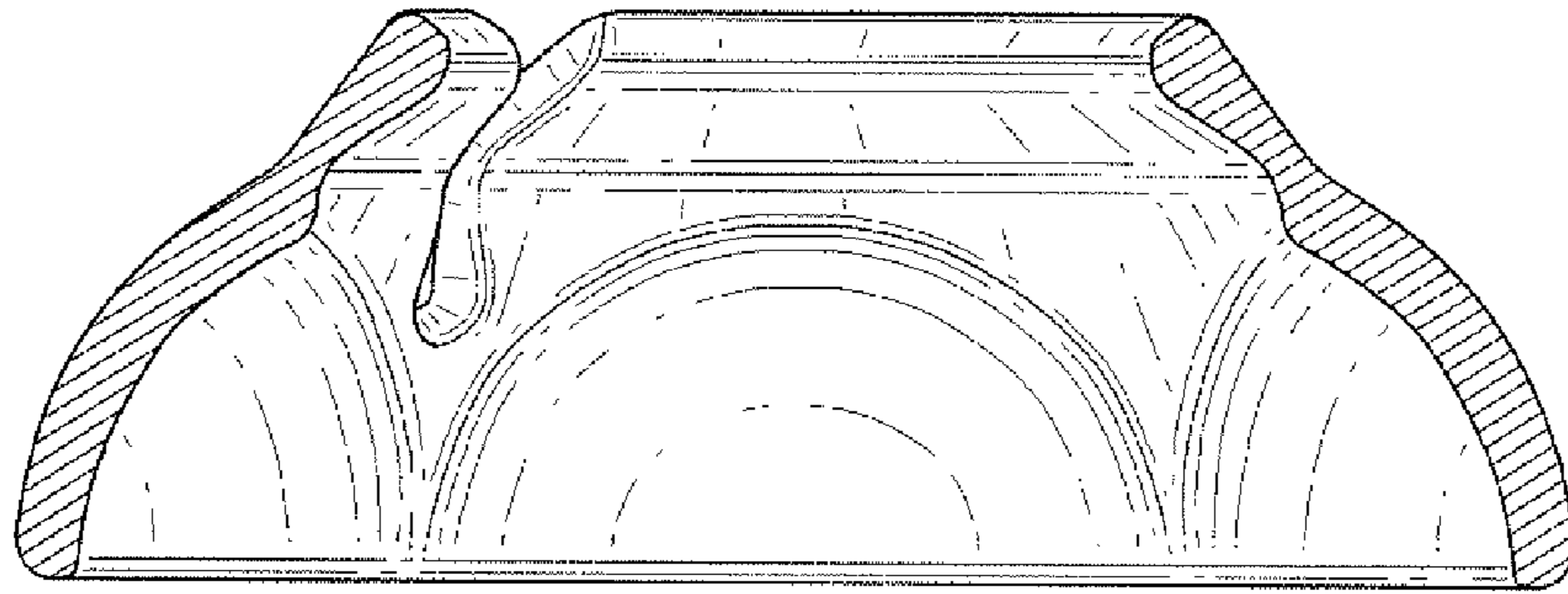

FIG. 4

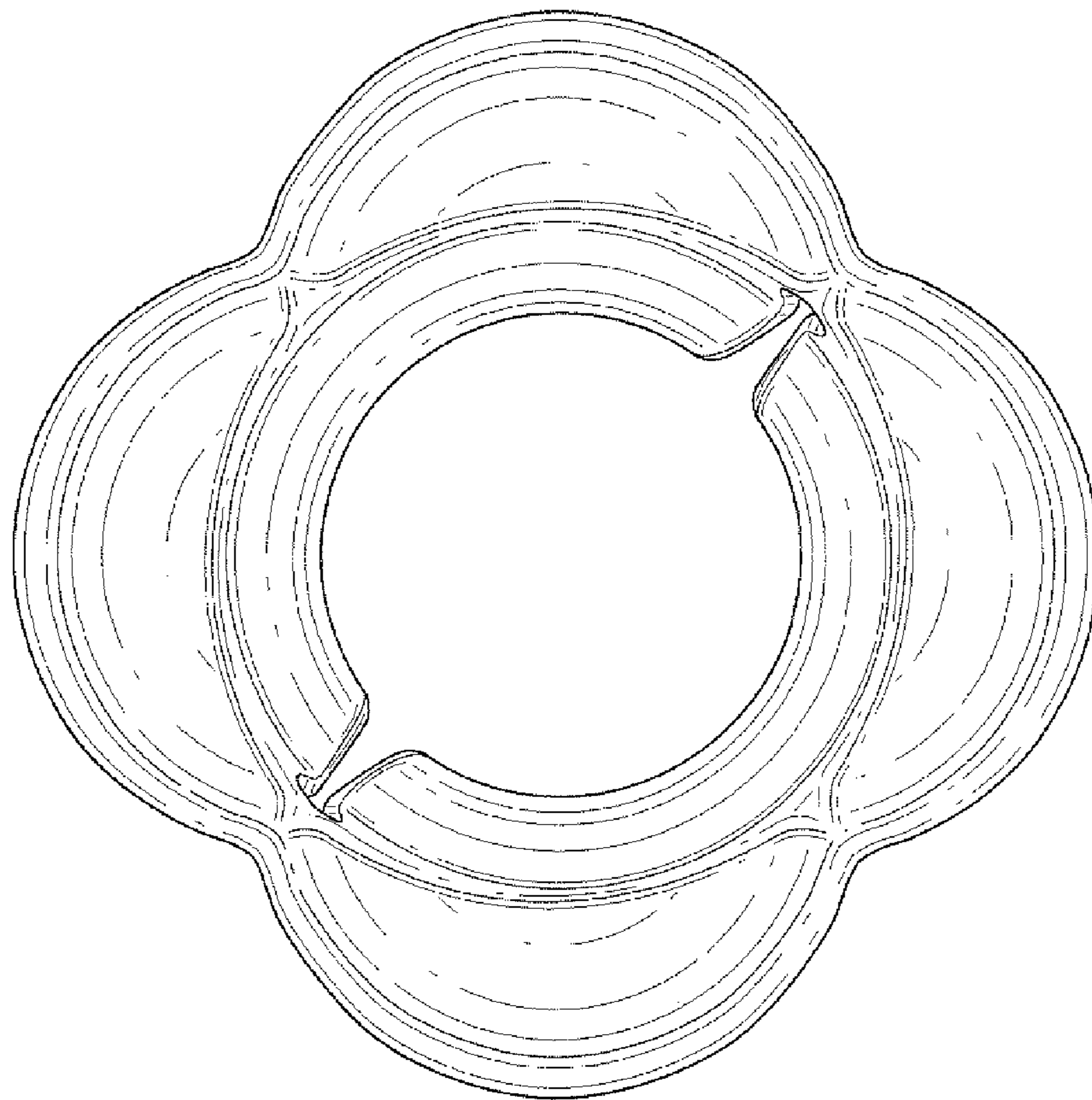

FIG. 5