



US00D676992S

(12) **United States Design Patent**
Trude

(10) **Patent No.:** **US D676,992 S**

(45) **Date of Patent:** **** Feb. 26, 2013**

(54) **CAP LAMP**

(75) **Inventor:** **Gregory Trude**, Clarks Summit, PA
(US)

(73) **Assignee:** **Koehler-Bright Star LLC**, Hanover
Township, PA (US)

(**) **Term:** **14 Years**

(21) **Appl. No.:** **29/412,188**

(22) **Filed:** **Jan. 31, 2012**

(51) **LOC (9) Cl.** **26-02**

(52) **U.S. Cl.** **D26/39**

(58) **Field of Classification Search** D26/37,
D26/38, 39, 46, 49; 362/103–108, 157, 158,
362/184, 194–208

See application file for complete search history.

(56) **References Cited**

U.S. PATENT DOCUMENTS

D270,482	S	*	9/1983	Jones	D26/37
D383,229	S	*	9/1997	Kiichiro	D26/39
D445,929	S	*	7/2001	Shing	D26/39
D518,210	S	*	3/2006	Nagano et al.	D26/39
D529,213	S	*	9/2006	Shiu	D26/39
D534,289	S	*	12/2006	Shiu	D26/39
D542,450	S	*	5/2007	Shiu	D26/60
D549,372	S	*	8/2007	Lee	D26/39
D557,842	S	*	12/2007	Lee	D26/39

D557,843	S	*	12/2007	Hillard	D26/39
D605,319	S	*	12/2009	Devaney et al.	D26/39
7,784,963	B2	*	8/2010	Galli et al.	362/184
D633,240	S	*	2/2011	Cheng	D26/60
D651,334	S	*	12/2011	Yuen	D26/50

* cited by examiner

Primary Examiner — Ian Simmons

Assistant Examiner — Carissa C Fitts

(74) *Attorney, Agent, or Firm* — R. Blake Johnston, Esq.;
DLA Piper US LLP

(57) **CLAIM**

The ornamental design for a cap lamp, as shown and described.

DESCRIPTION

FIG. 1 is a perspective view of the cap lamp;
FIG. 2 is a front elevational view of the cap lamp;
FIG. 3 is a rear elevational view of the cap lamp;
FIG. 4 is a left side elevational view of the cap lamp, the
opposite side of which is a mirror image;
FIG. 5 is a top plan view of the cap lamp; and,
FIG. 6 is a bottom plan view of the cap lamp.
The broken lines shown are included for the purpose of illus-
trating the unclaimed portions of the article and form no part
of the claimed design.

1 Claim, 6 Drawing Sheets

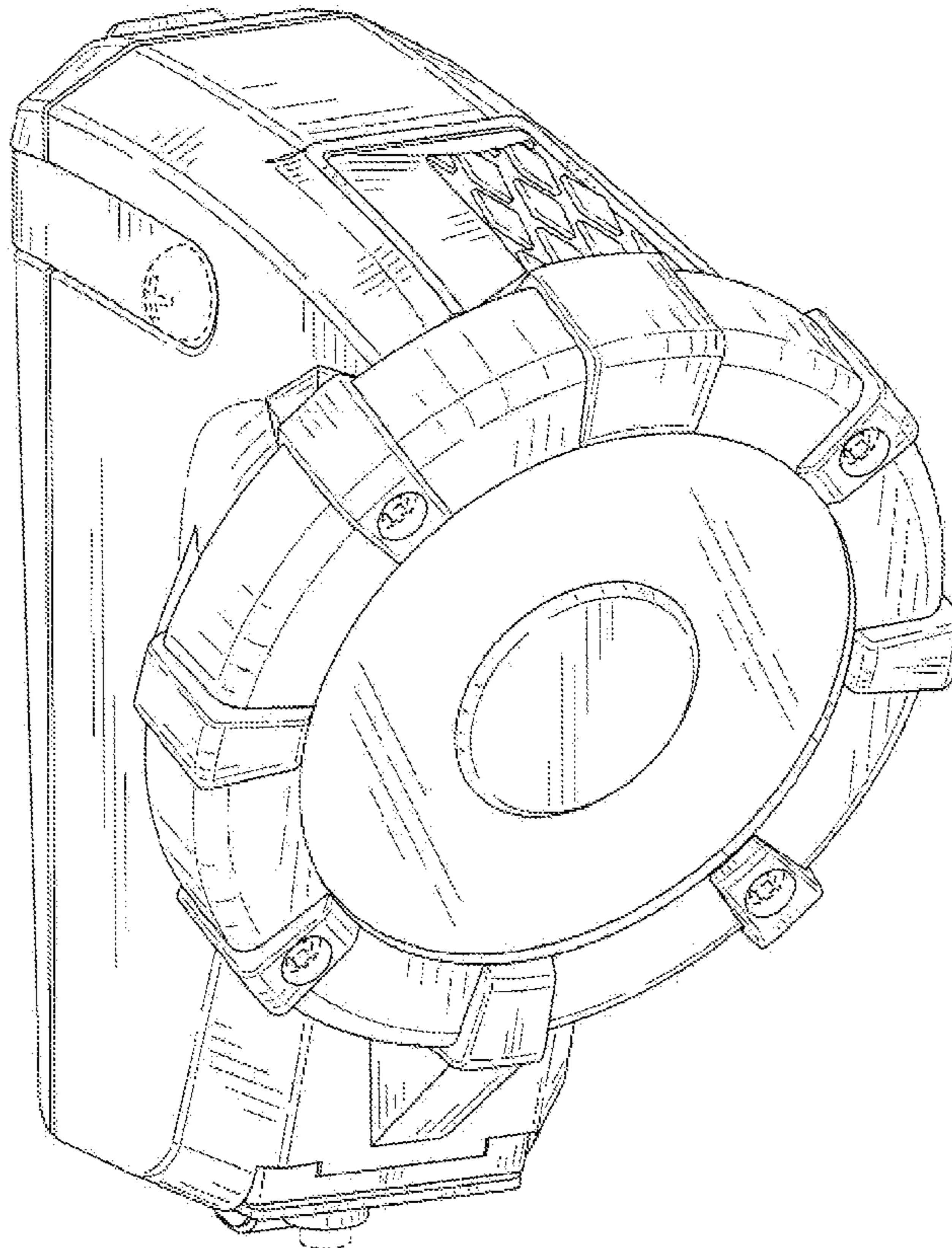

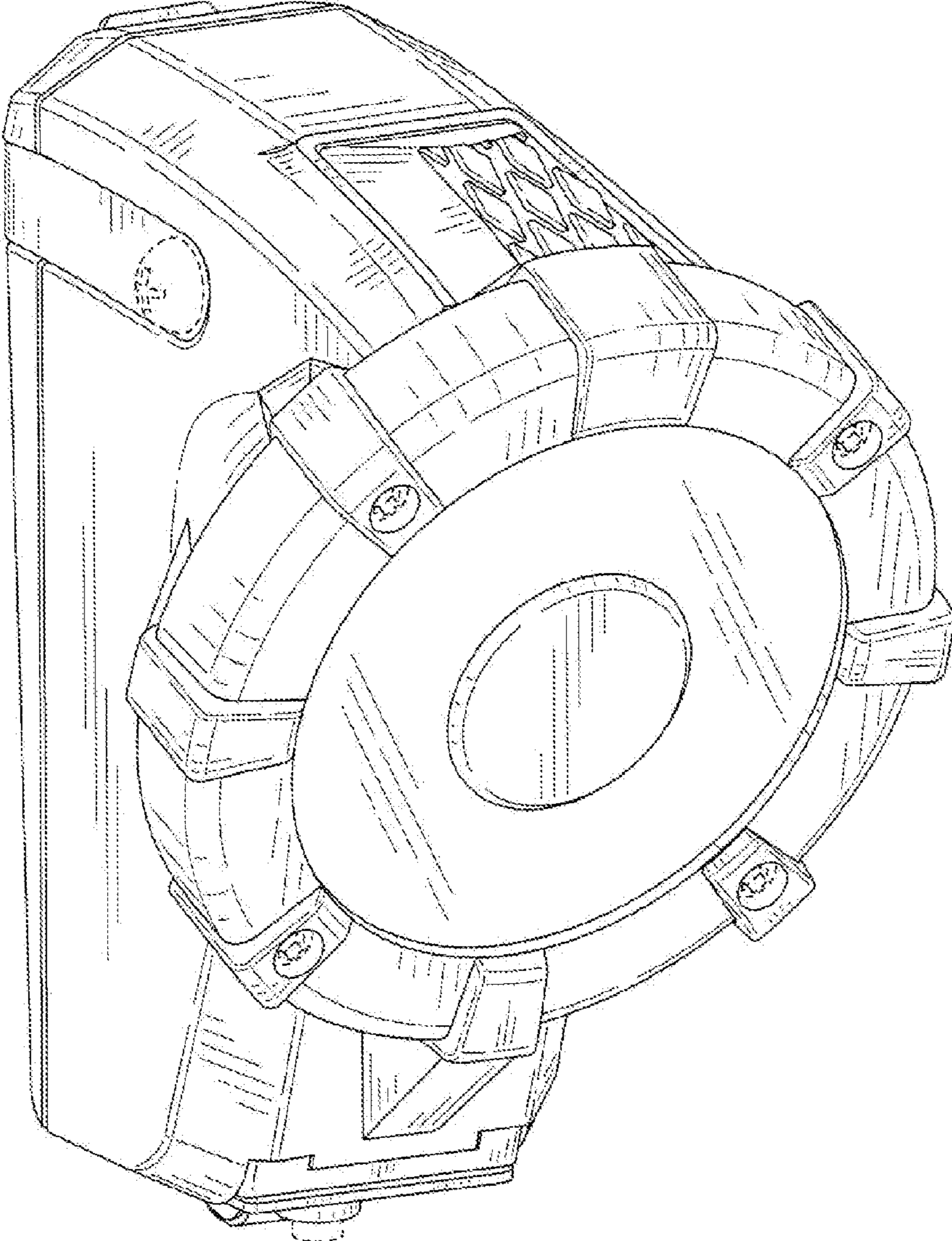

FIG. 1

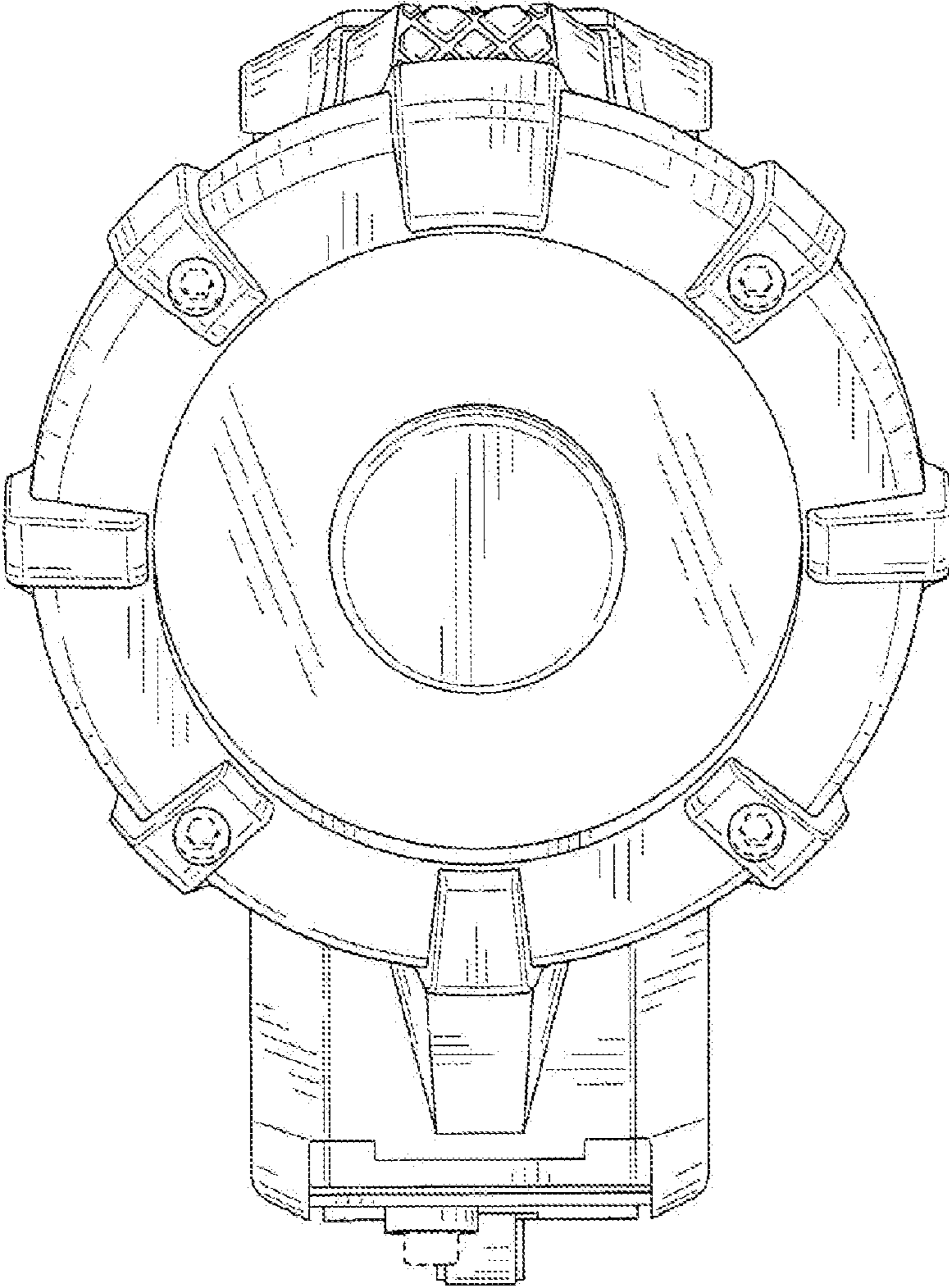

FIG. 2

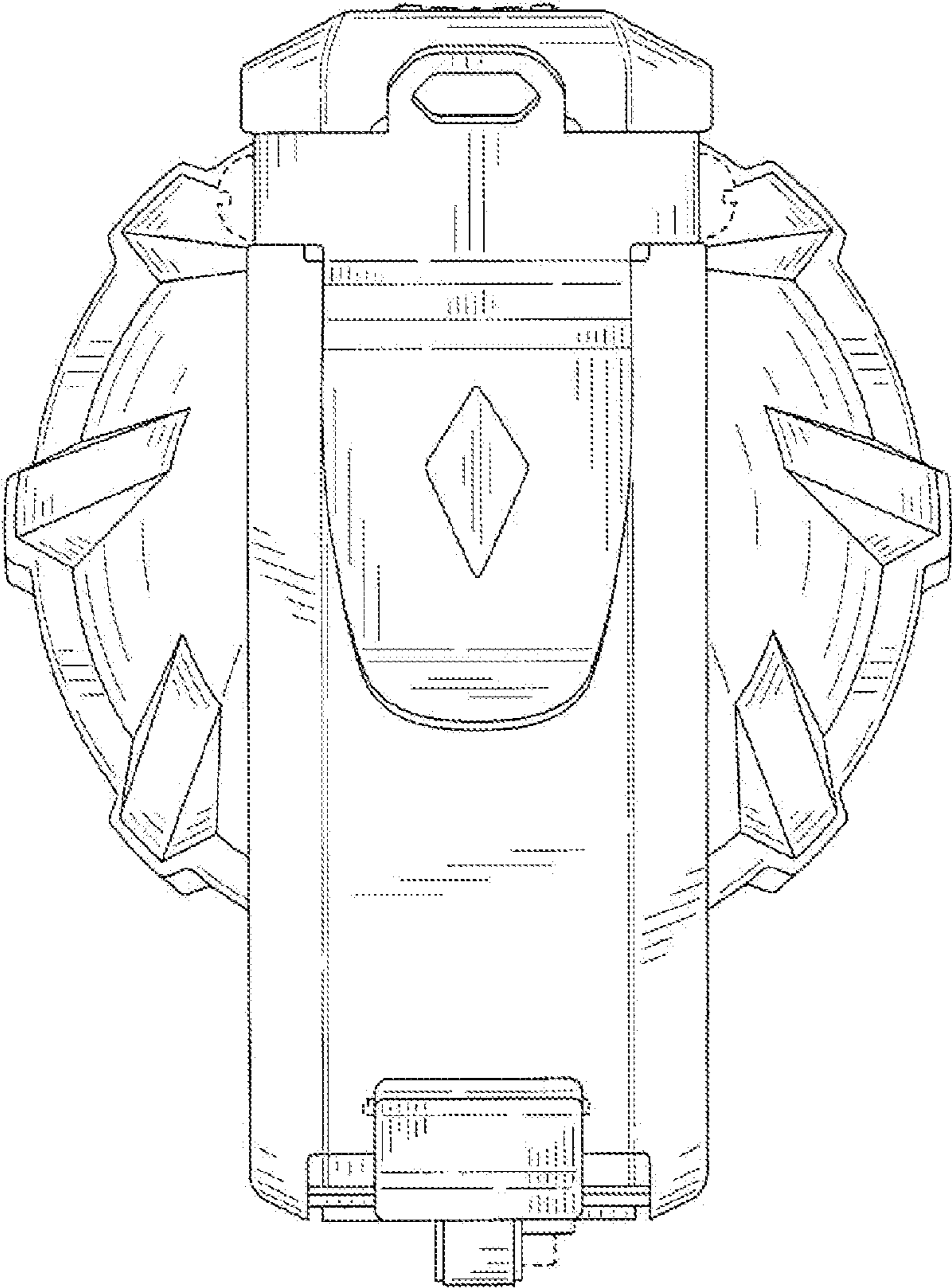

FIG. 3

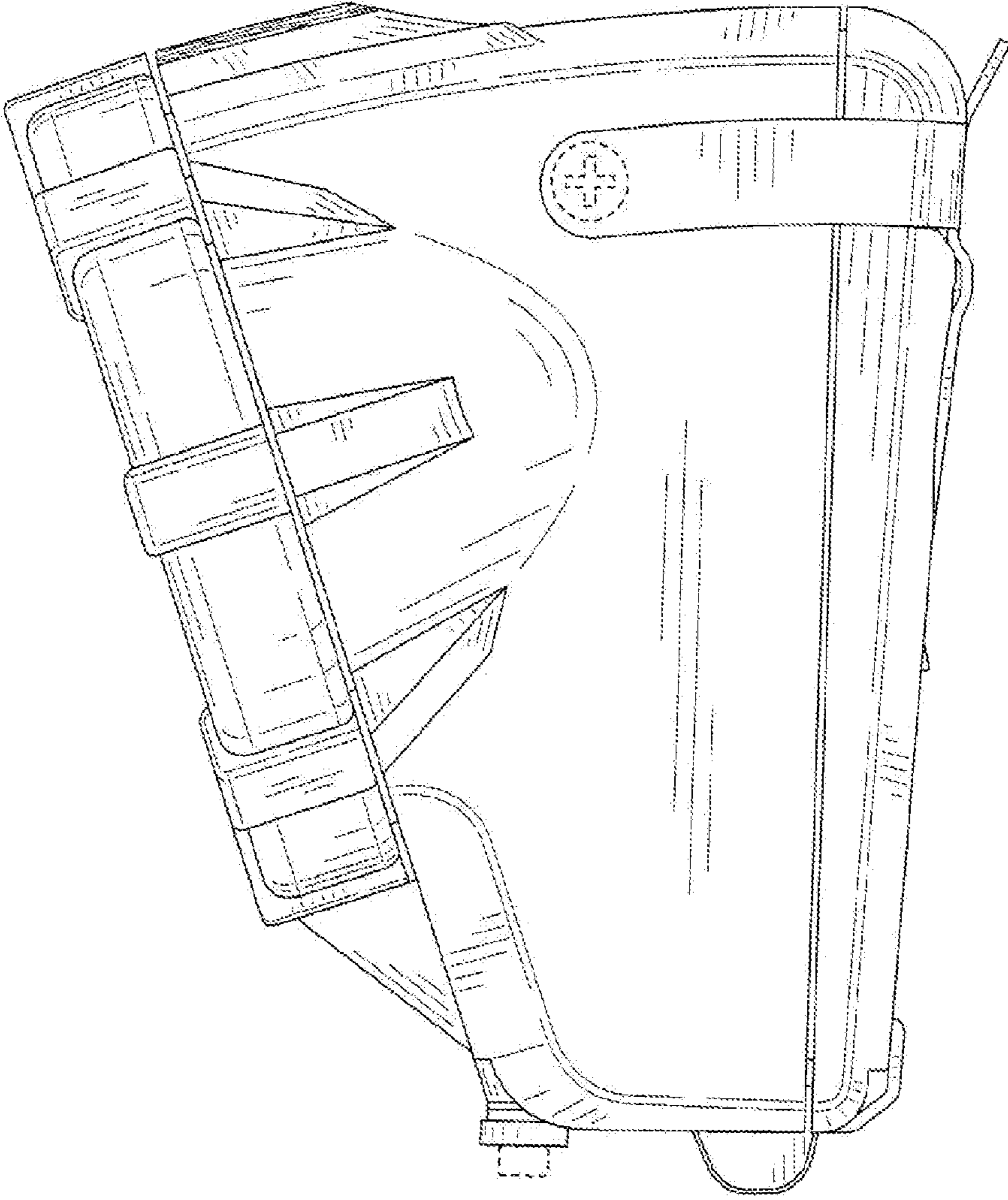

FIG. 4

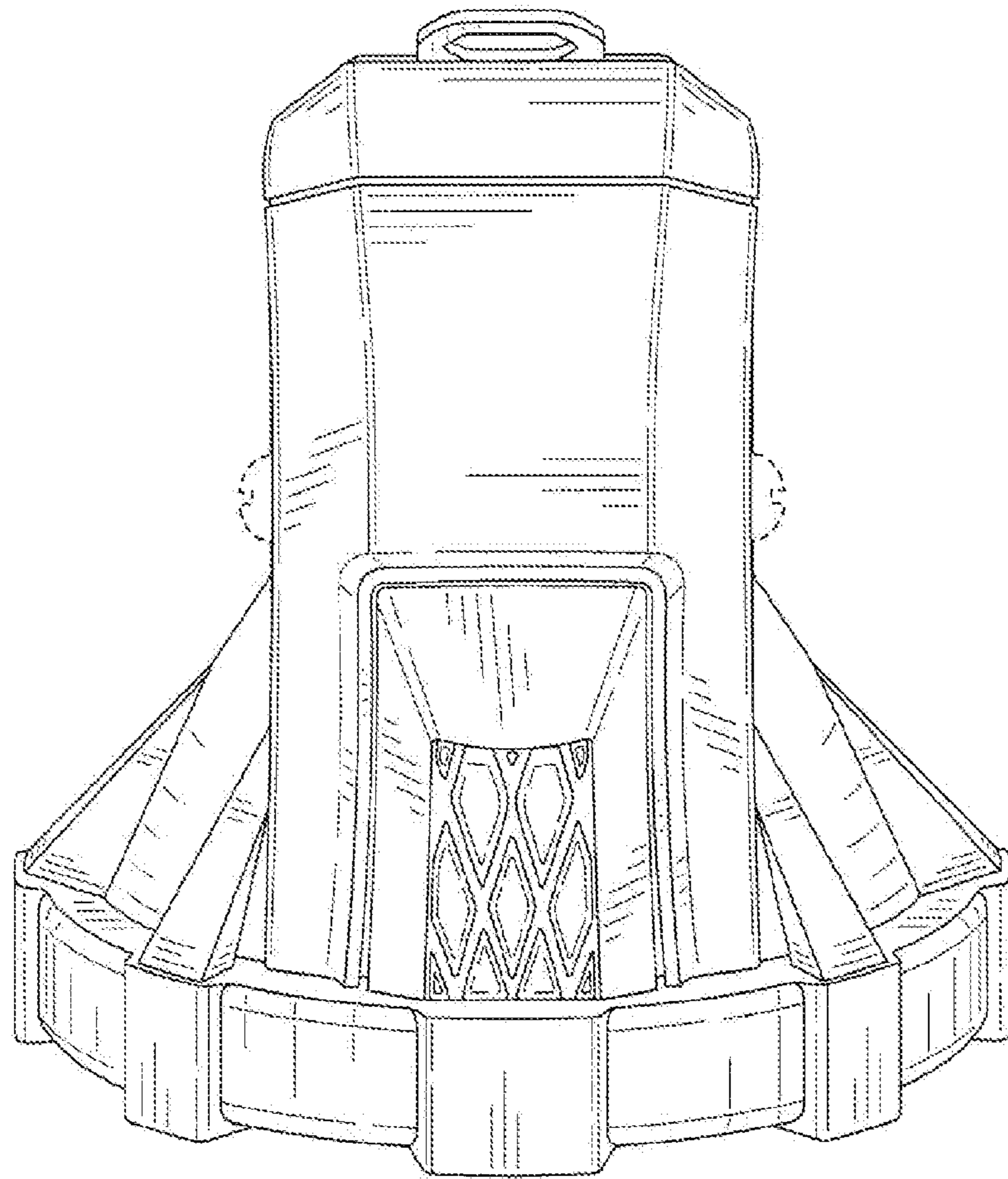

FIG. 5

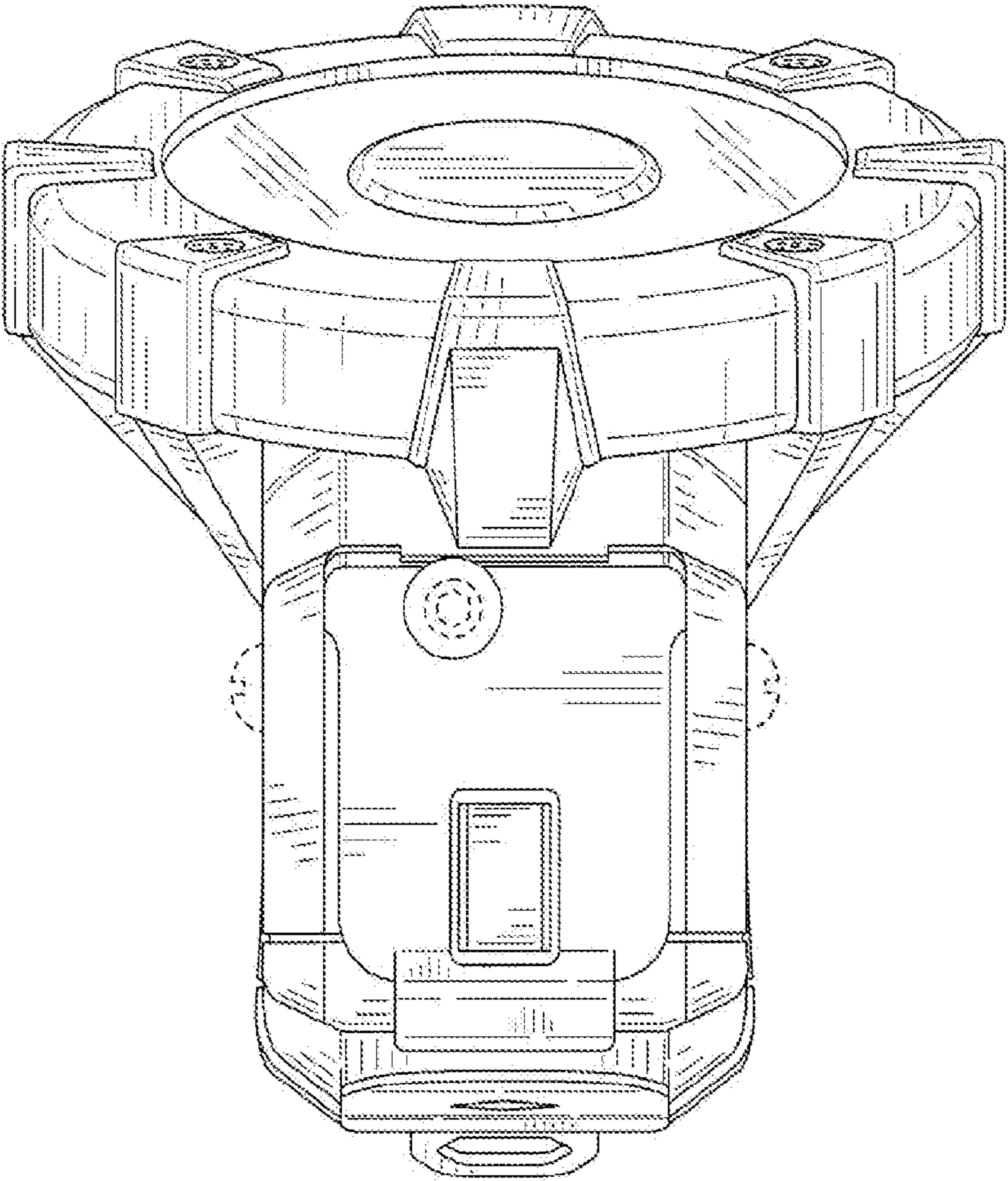

FIG. 6