



US00D676944S

(12) **United States Design Patent**
Schindler

(10) **Patent No.:** **US D676,944 S**

(45) **Date of Patent:** **** Feb. 26, 2013**

(54) **SINK AND STOVE WITH RACK**
(75) Inventor: **Kilian Schindler**, Karlsruhe (DE)
(73) Assignee: **Naber Holding GmbH & Co. KG** (DE)
(**) Term: **14 Years**

D260,209 S * 8/1981 Ferdinand et al. D6/481
D466,717 S * 12/2002 Cho D6/400
D483,531 S * 12/2003 Shelley D32/2
D547,972 S * 8/2007 Pflaster D6/426
D553,398 S * 10/2007 LeTourneau D6/484
D585,119 S * 1/2009 Kitzmiller D23/287

* cited by examiner

(21) Appl. No.: **29/400,069**
(22) Filed: **Aug. 23, 2011**

Primary Examiner — Robert Delehanty
(74) *Attorney, Agent, or Firm* — Brian B. Diekhoff;
Polsinelli Shughart PC

(30) **Foreign Application Priority Data**
Feb. 23, 2011 (EP) 001825274
(51) **LOC (9) Cl.** **23-02**
(52) **U.S. Cl.** **D23/286; D23/287; D6/451; D6/483**
(58) **Field of Classification Search** D23/284,
D23/286, 287, 293.1, 308; 4/619, 630–631,
4/637–638; D6/451, 481, 483
See application file for complete search history.

(57) **CLAIM**
The ornamental design for a sink and stove with rack, as shown and described.

(56) **References Cited**
U.S. PATENT DOCUMENTS
D253,787 S * 12/1979 Kinsey D23/287
D254,112 S * 2/1980 Handler et al. D6/431

DESCRIPTION

FIG. 1 is a perspective view of the sink and stove with rack;
FIG. 2 is a top view of the sink and stove with rack;
FIG. 3 is a bottom view of the sink and stove with rack;
FIG. 4 is a front view of the sink and stove with rack;
FIG. 5 is a rear view of the sink and stove with rack; and,
FIG. 6 is a side view of the sink and stove with rack.

1 Claim, 6 Drawing Sheets

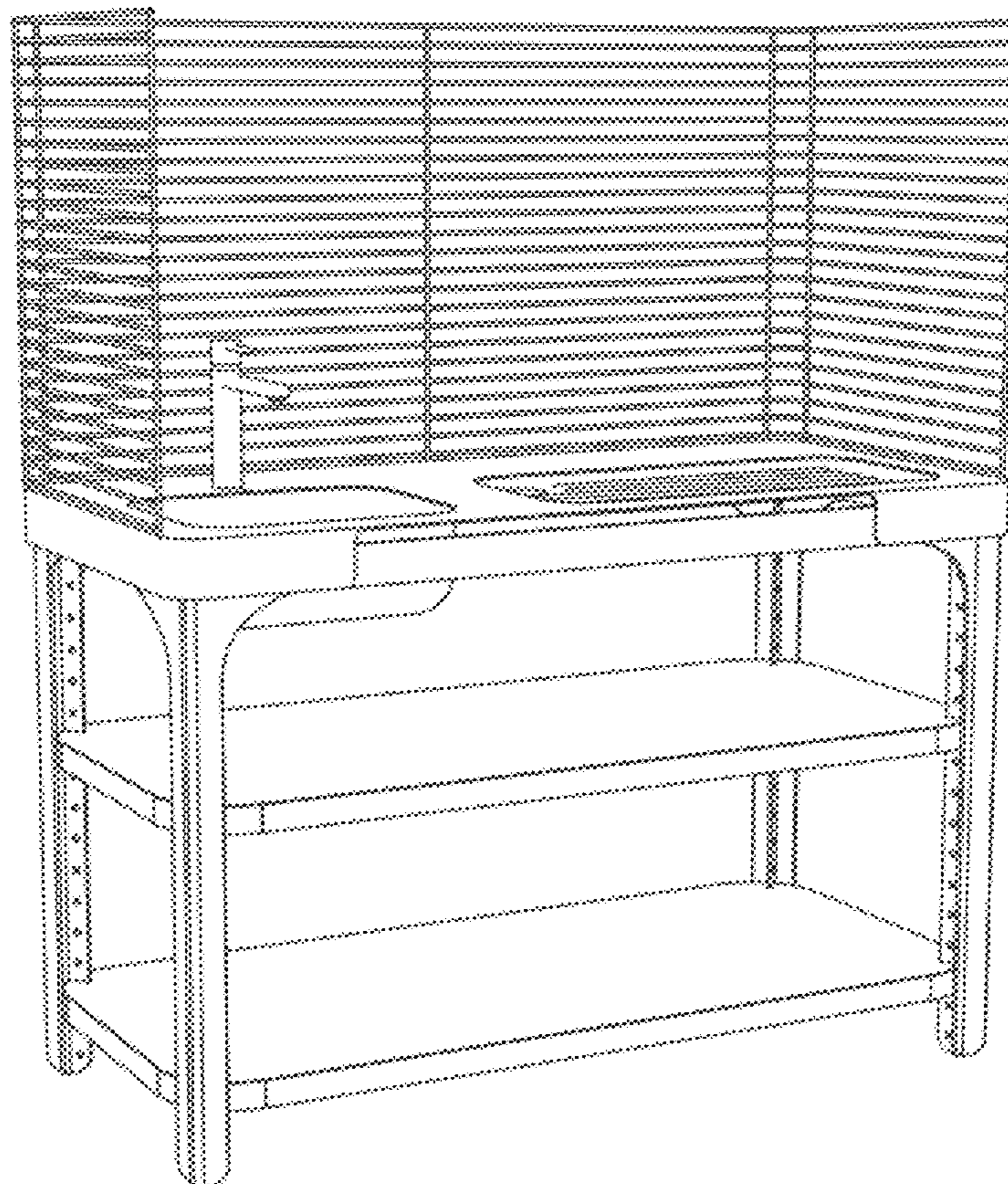

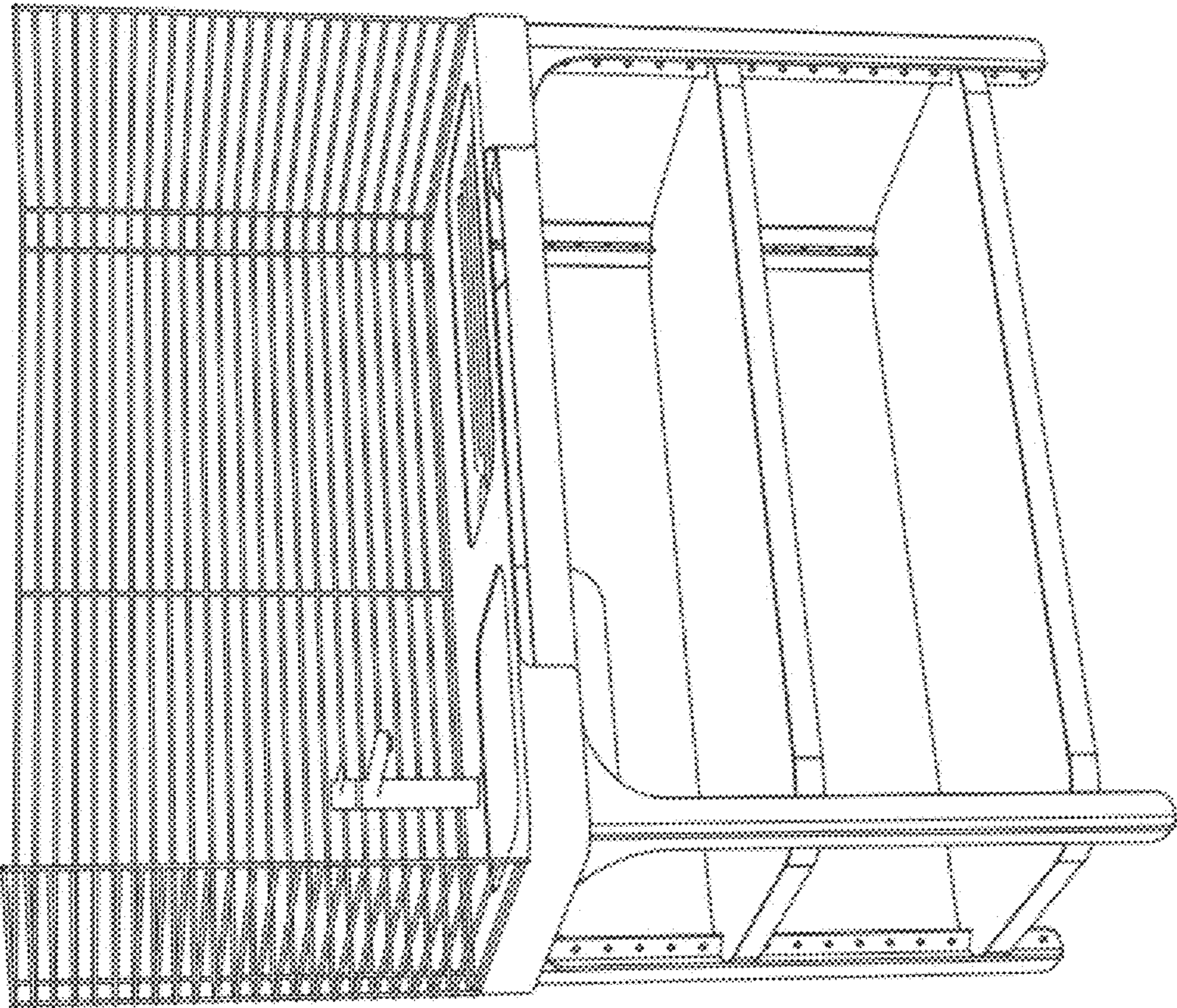

FIG. 1

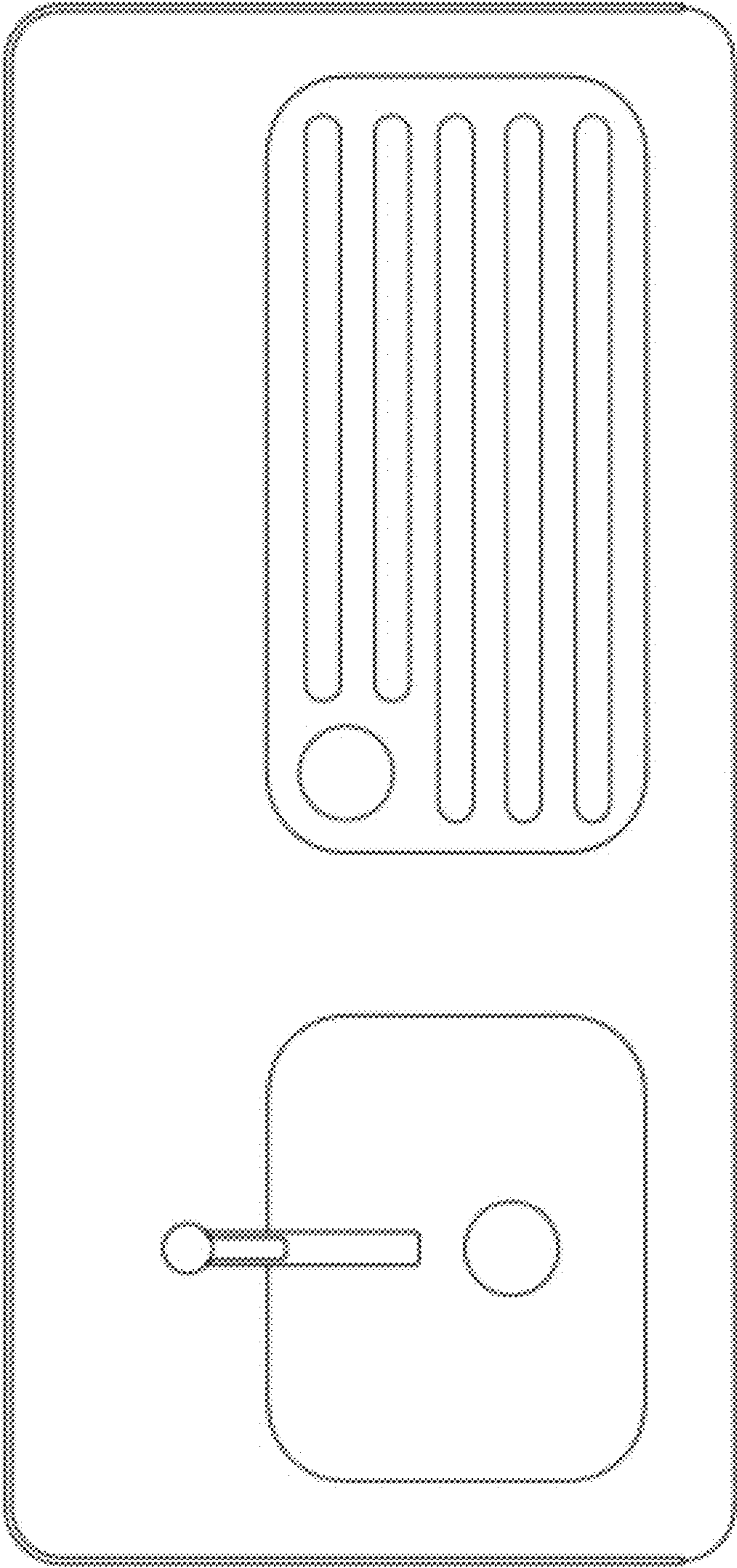

FIG. 2

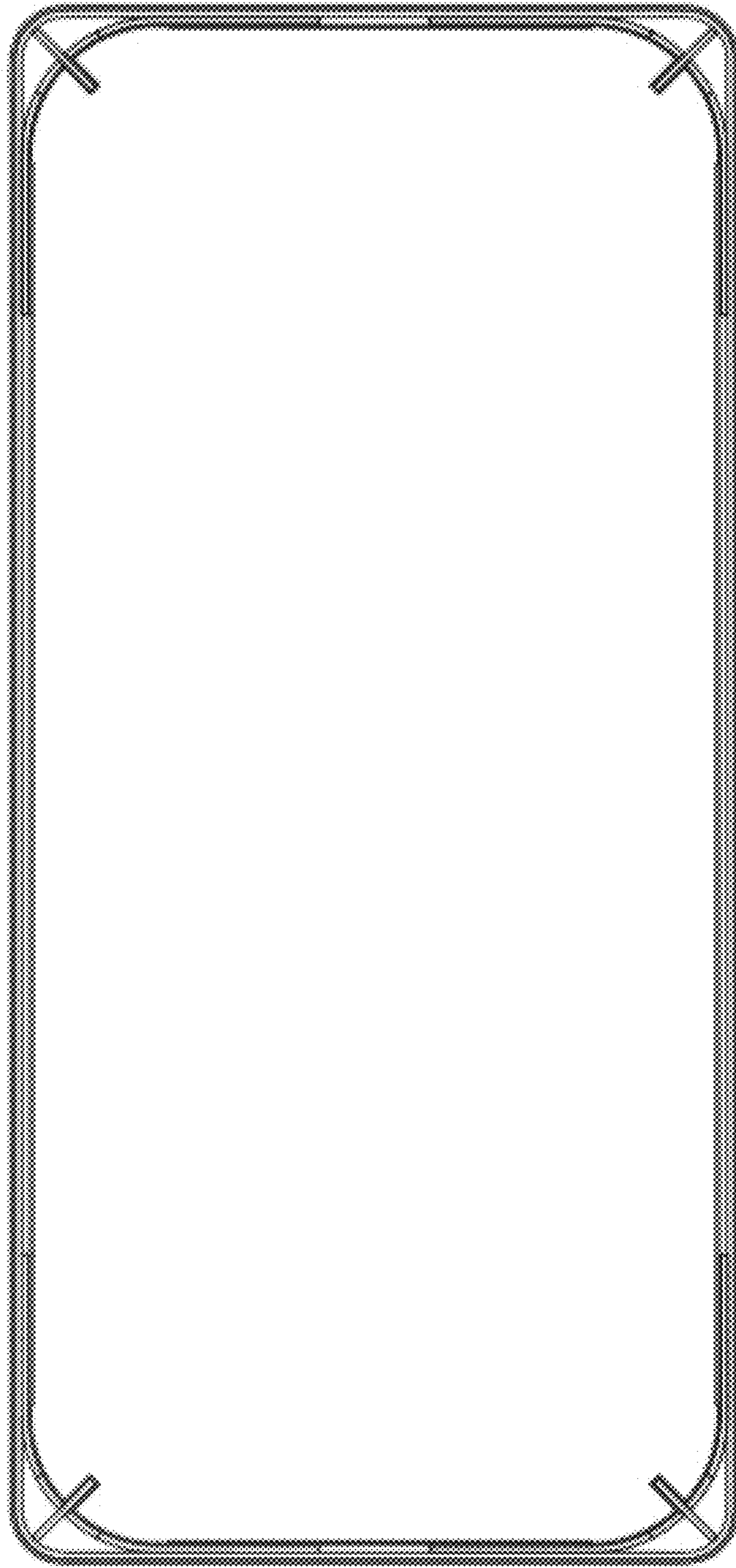

FIG. 3

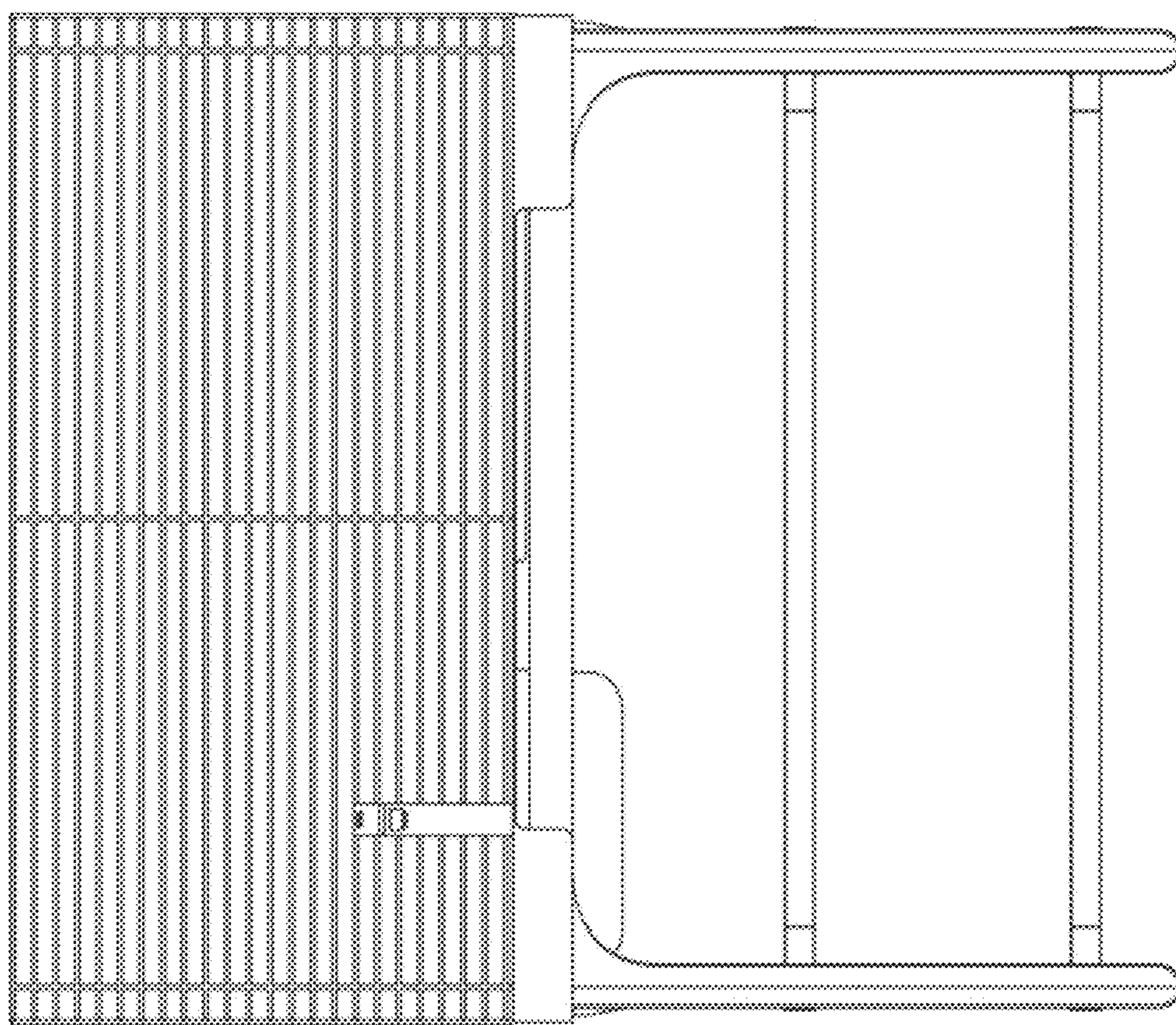

FIG. 4

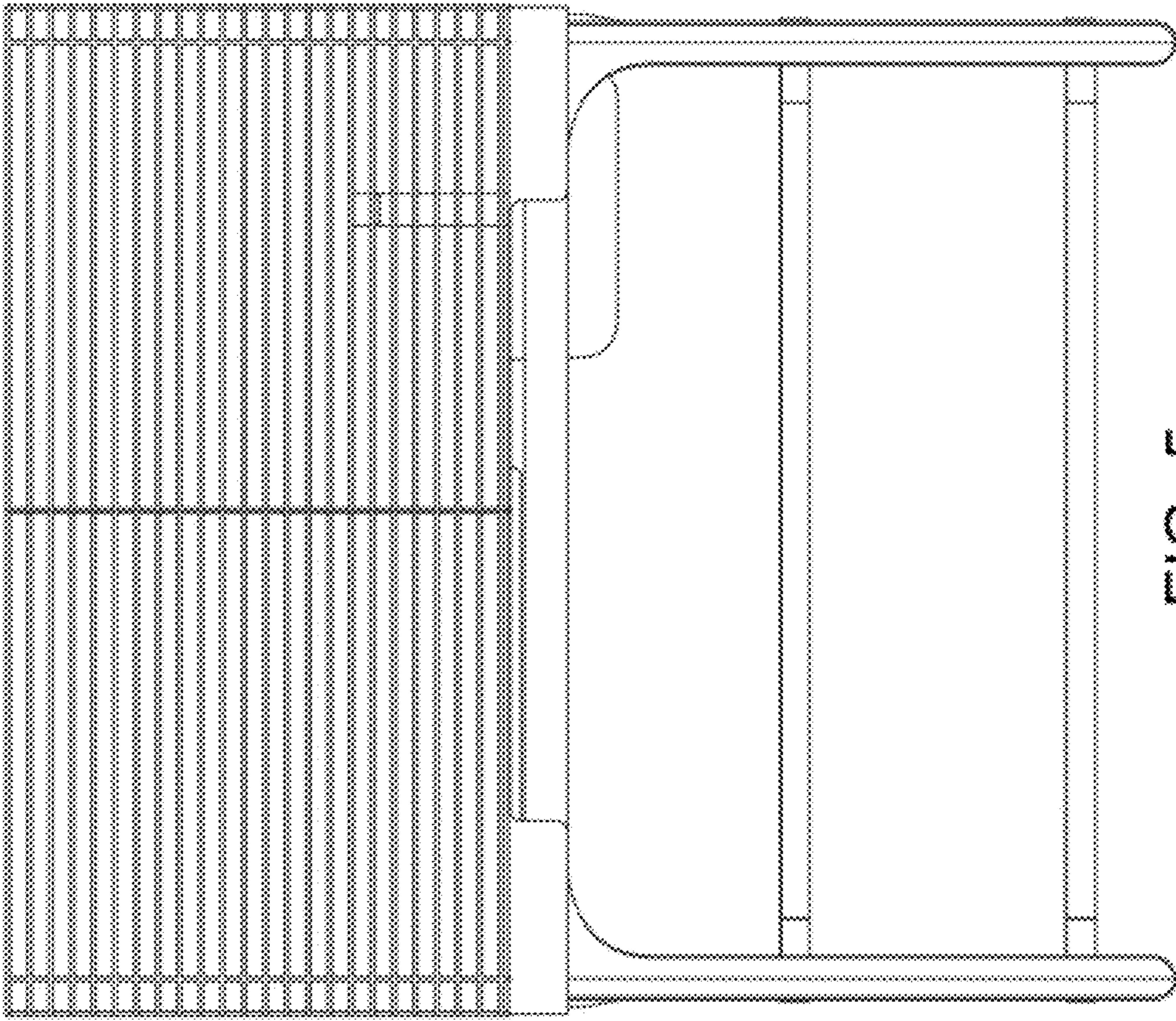

FIG. 5

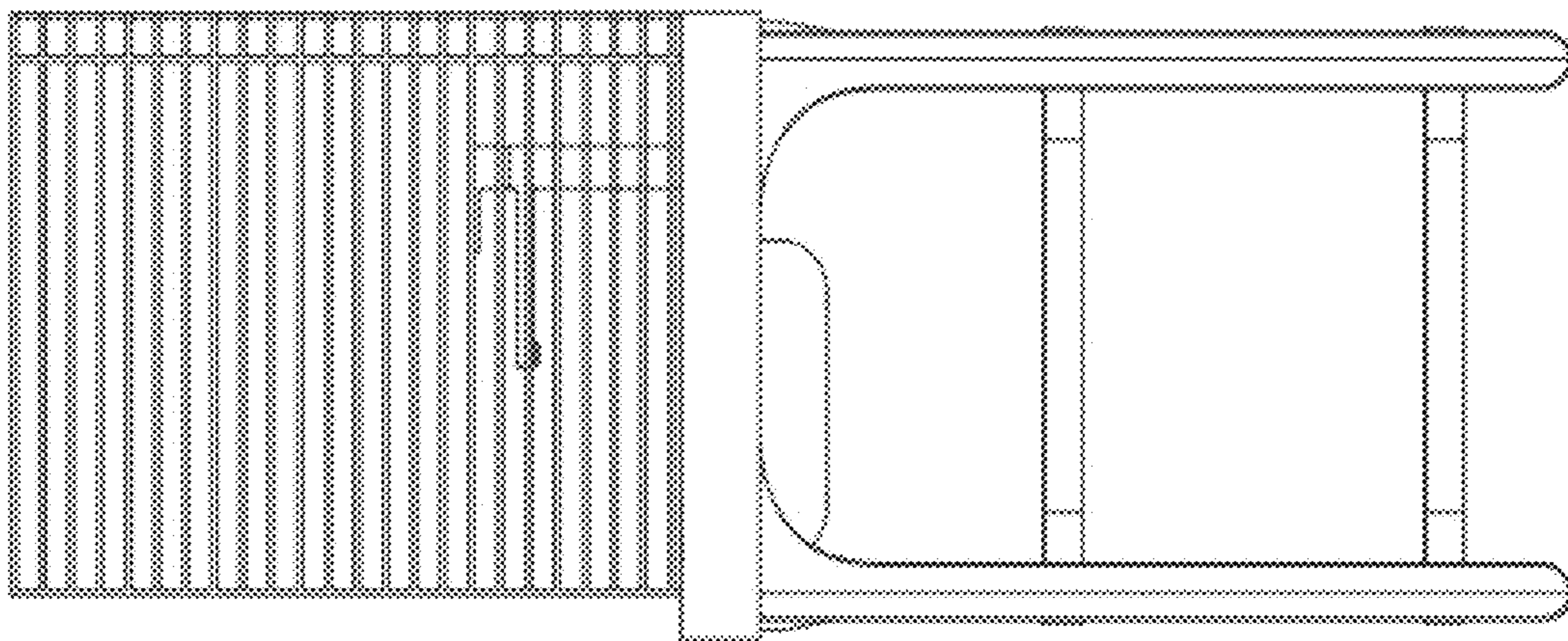

FIG. 6