



US00D676937S

(12) **United States Design Patent**
Romero et al.

(10) **Patent No.:** **US D676,937 S**
(45) **Date of Patent:** **** Feb. 26, 2013**

(54) **FAUCET HANDLE**

(75) Inventors: **Emilie Williams Romero**, Chicago, IL (US); **Anthony Spangler**, Indianapolis, IN (US)

(73) Assignee: **Masco Corporation of Indiana**, Indianapolis, IN (US)

(**) Term: **14 Years**

(21) Appl. No.: **29/418,018**

(22) Filed: **Apr. 11, 2012**

(51) **LOC (9) Cl.** **23-01**

(52) **U.S. Cl.** **D23/252**

(58) **Field of Classification Search** D23/238-243,
D23/250, 252, 254, 249, 245; 4/675-678;
137/801

See application file for complete search history.

(56) **References Cited**

U.S. PATENT DOCUMENTS

D583,019 S * 12/2008 Soriano D23/250

* cited by examiner

Primary Examiner — Robert Delehanty

(74) *Attorney, Agent, or Firm* — Edgar A. Zarins; Nirav D. Parikh; Lora J. Graentzcoerffer

(57) **CLAIM**

The ornamental design for a faucet handle, as shown and described.

DESCRIPTION

FIG. 1 is a perspective view of a faucet handle showing our new design;
FIG. 2 is a top plan view thereof;
FIG. 3 is a first side view thereof;
FIG. 4 is a second side view thereof;
FIG. 5 is a first end view thereof;
FIG. 6 is a second end view thereof; and,
FIG. 7 is a bottom view thereof.

1 Claim, 1 Drawing Sheet

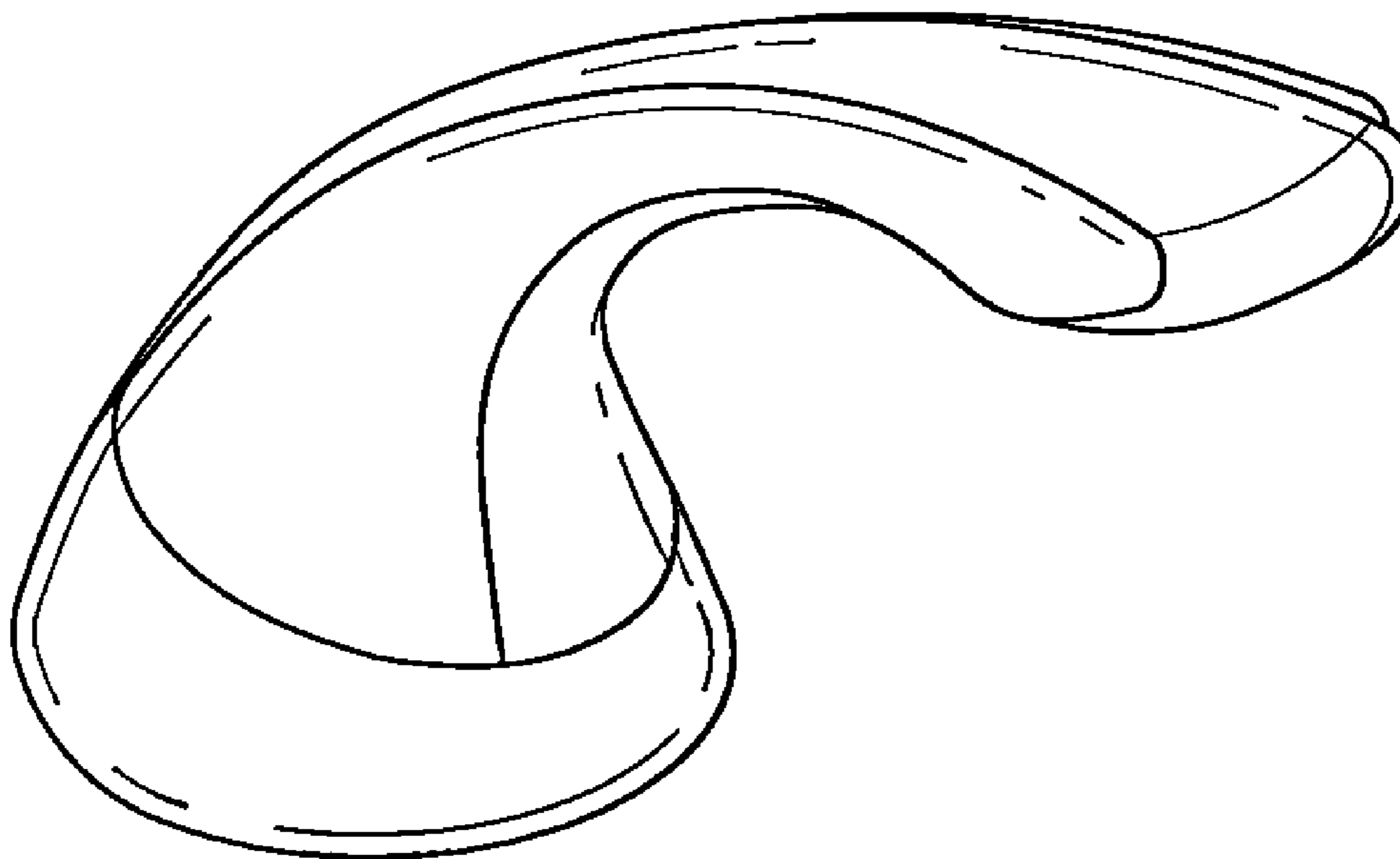

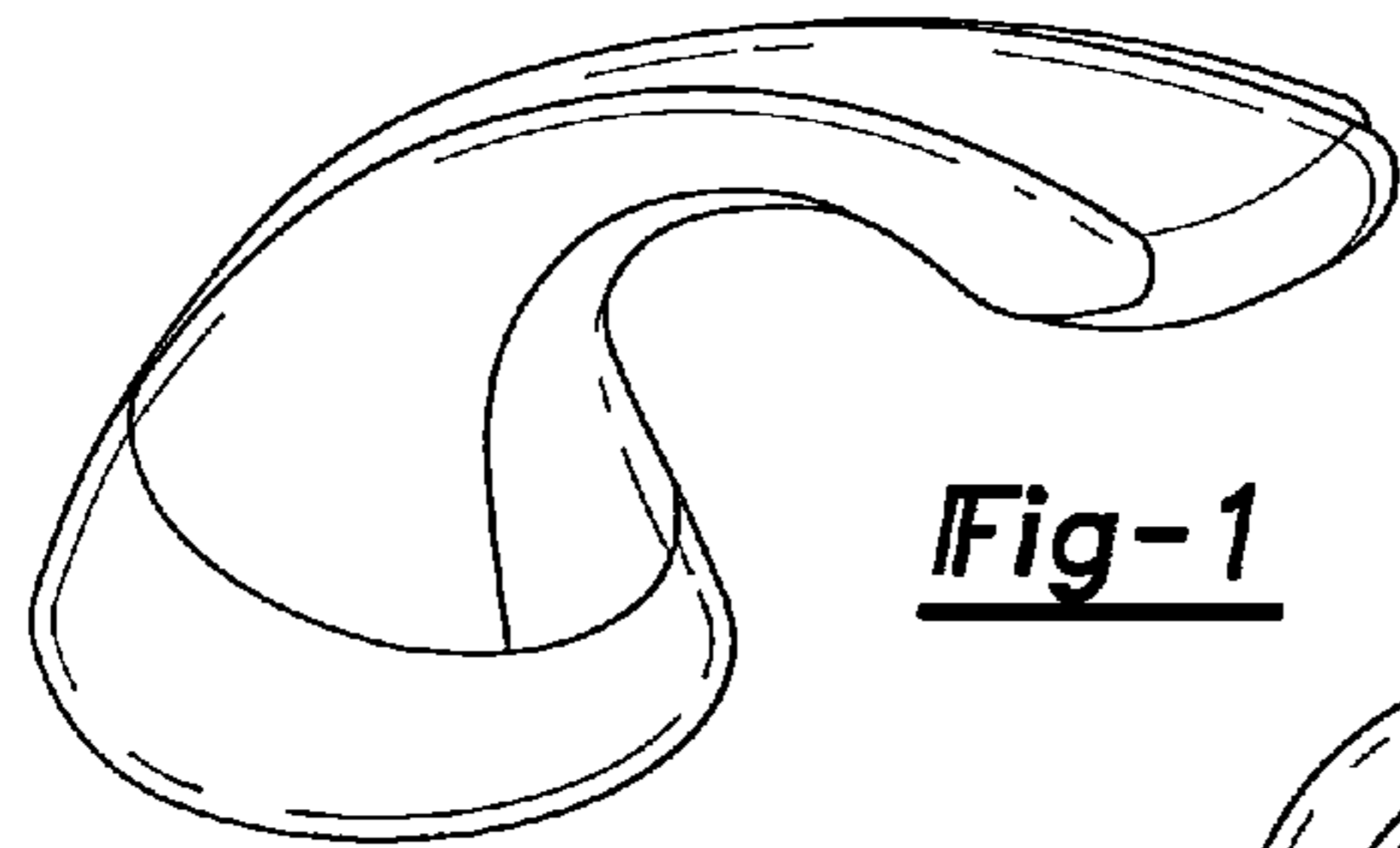

Fig-1

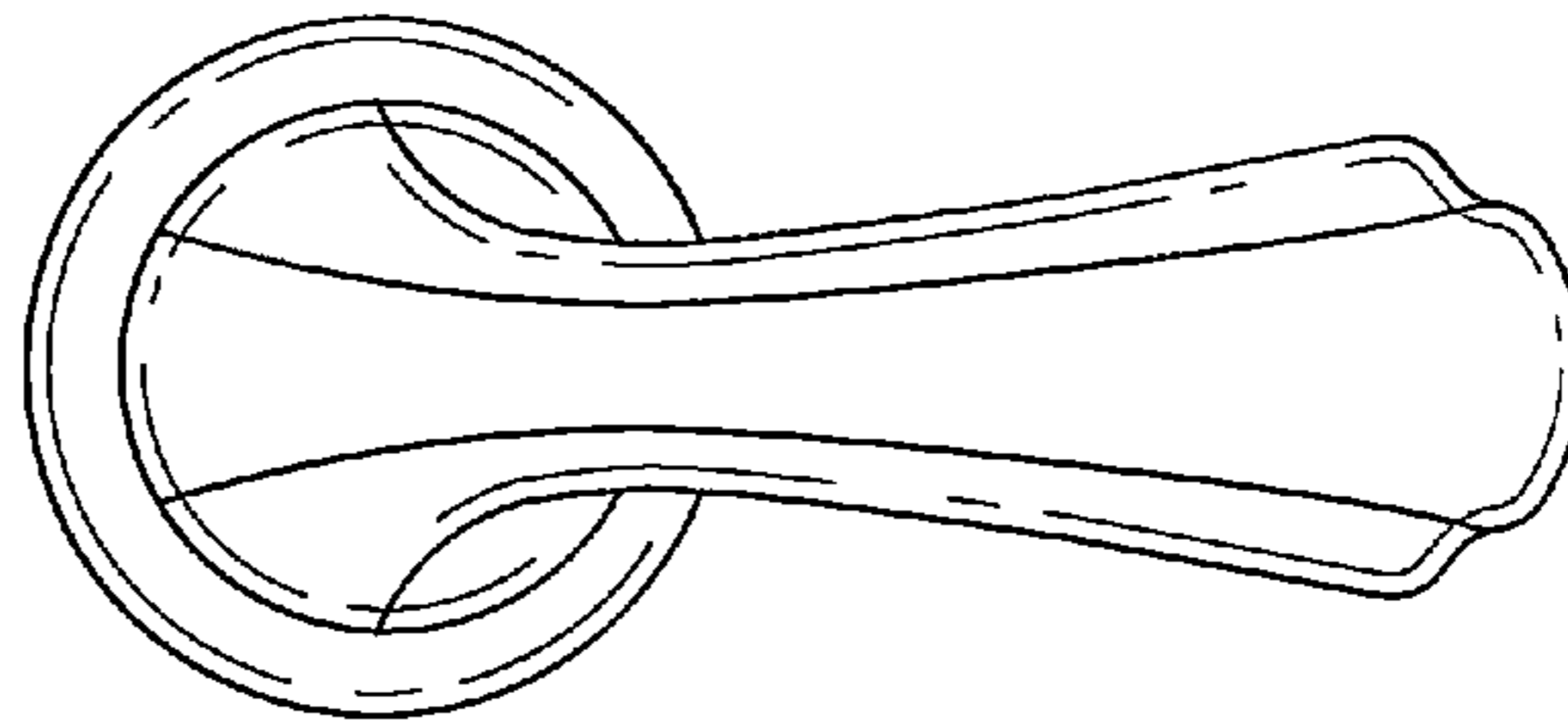

Fig-2

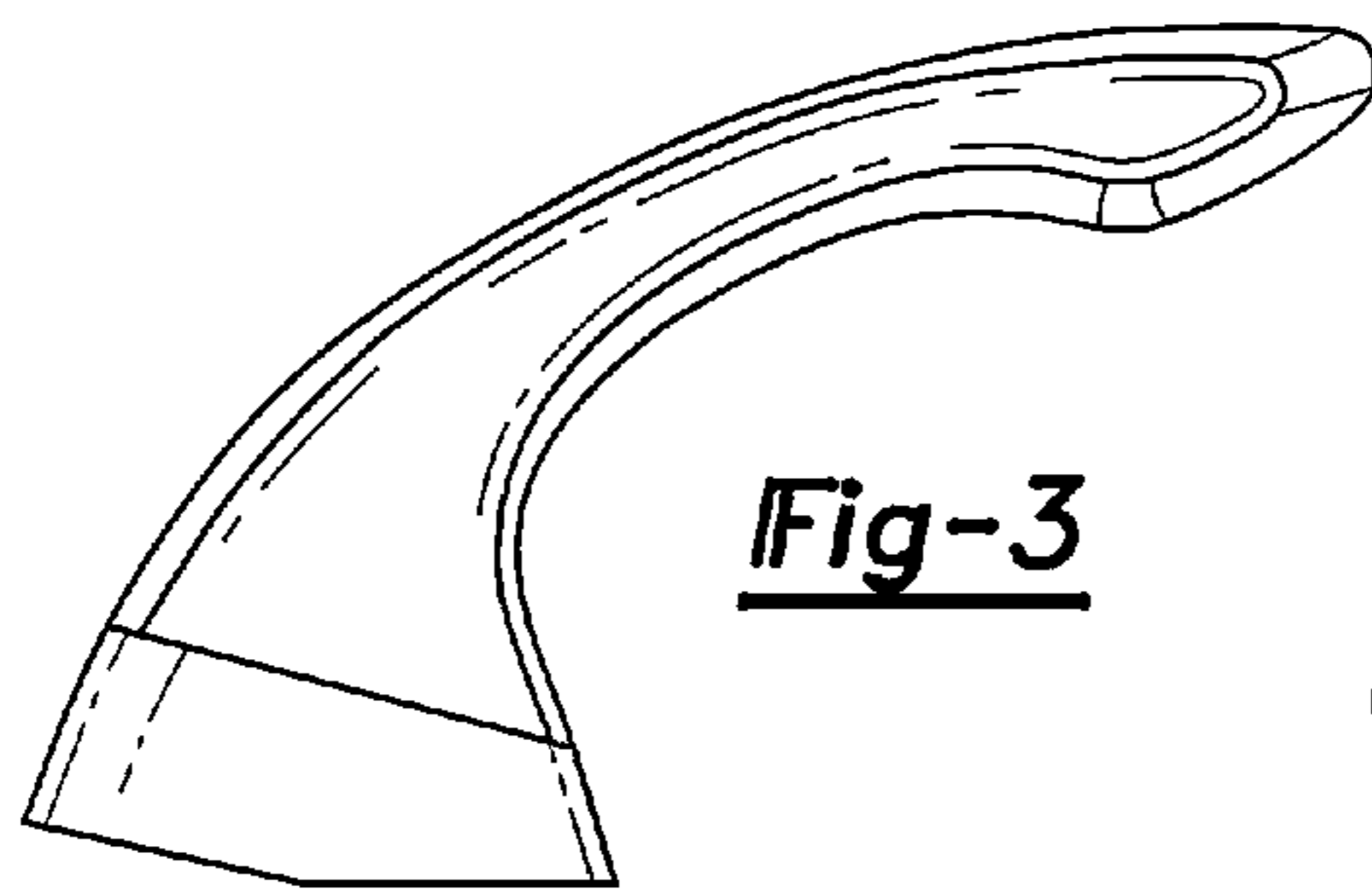

Fig-3

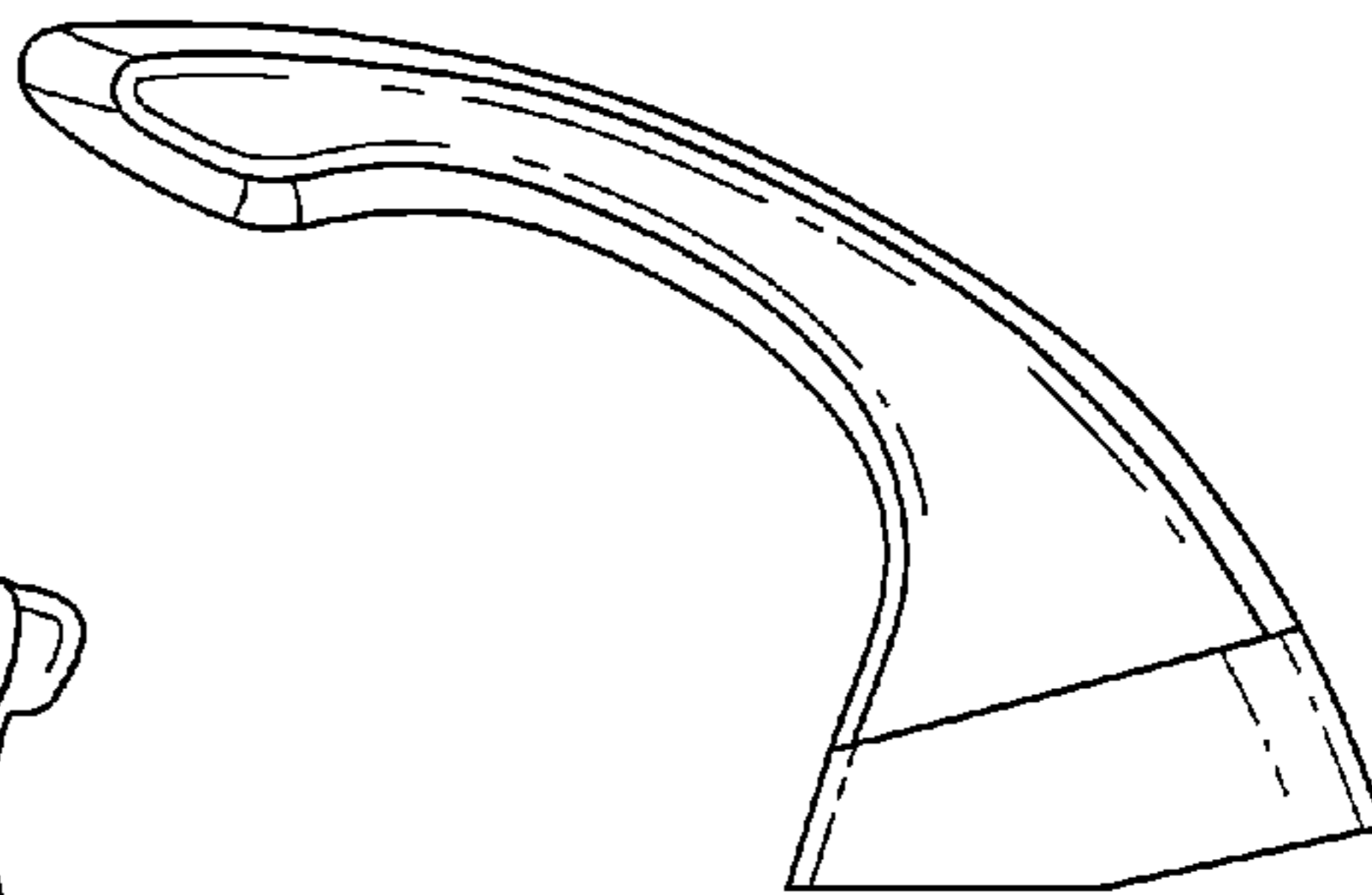

Fig-4

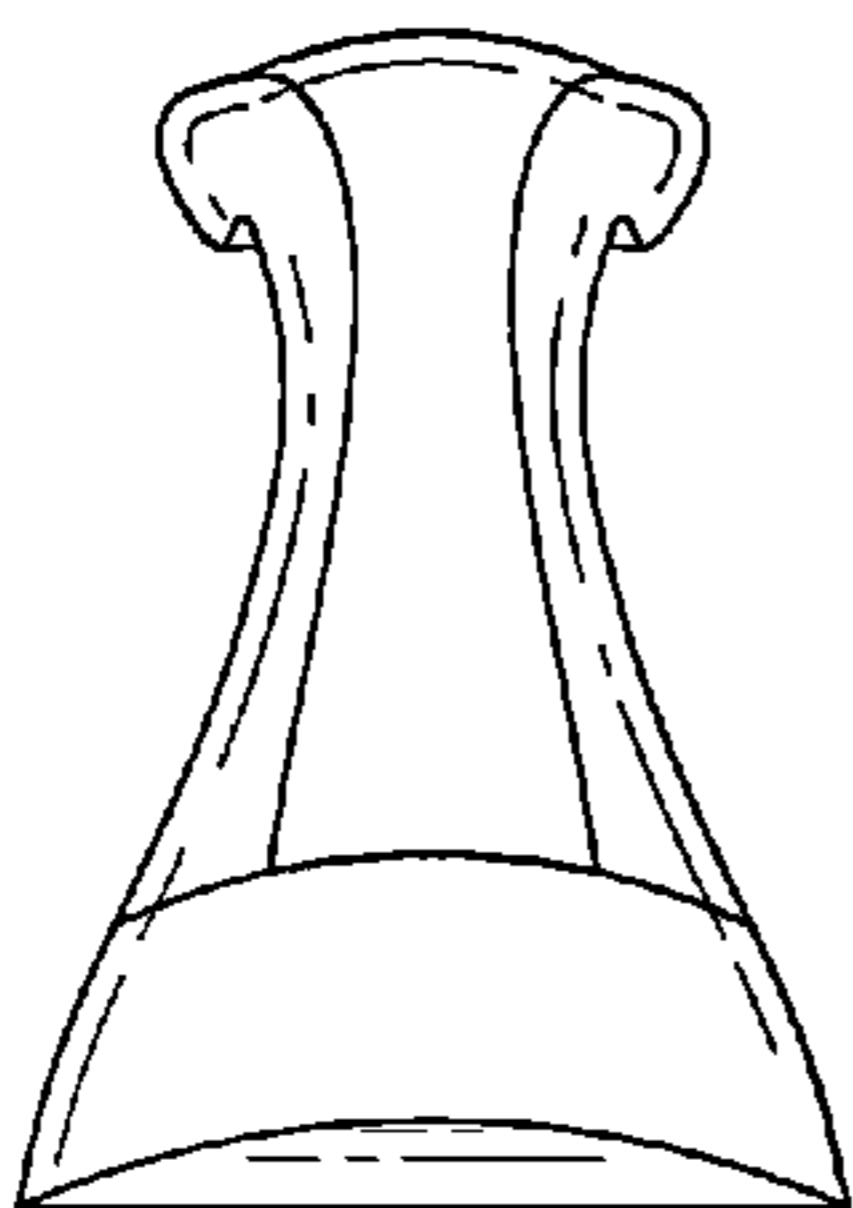

Fig-5

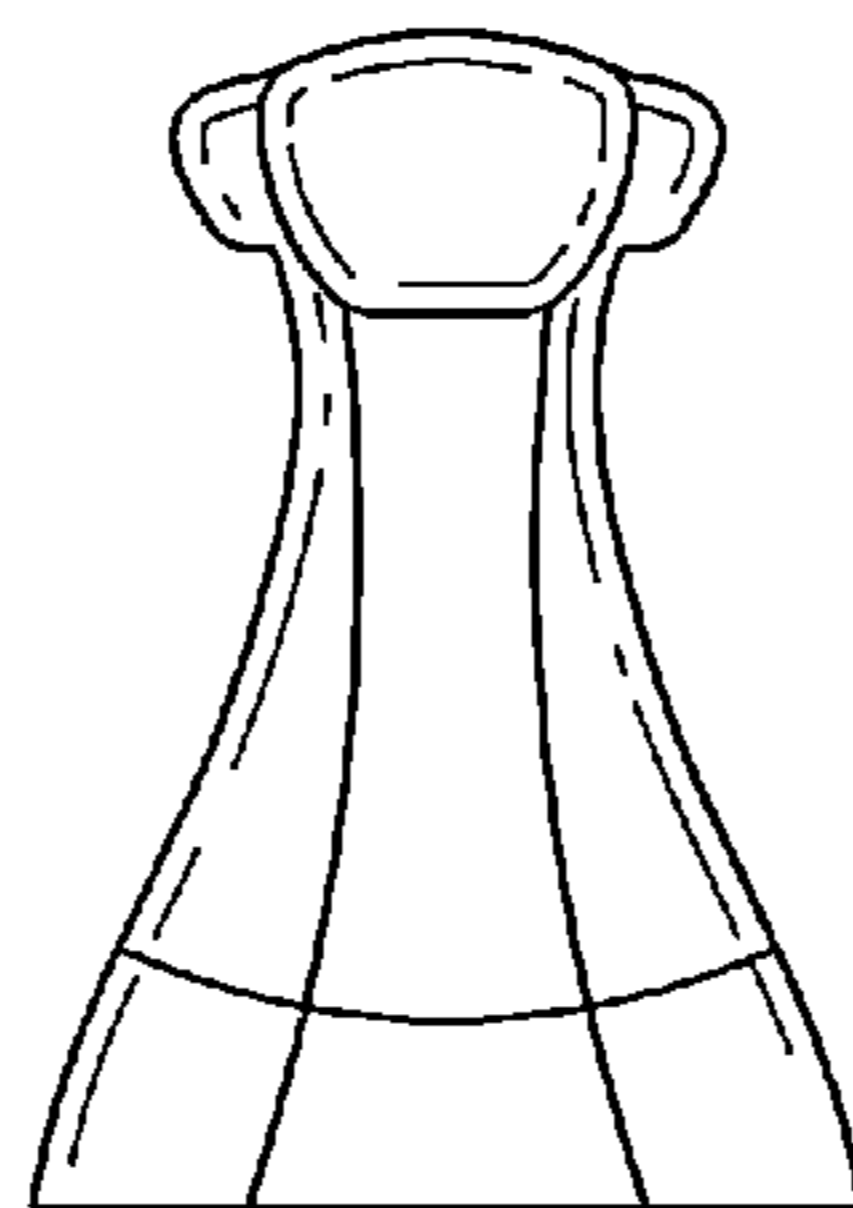

Fig-6

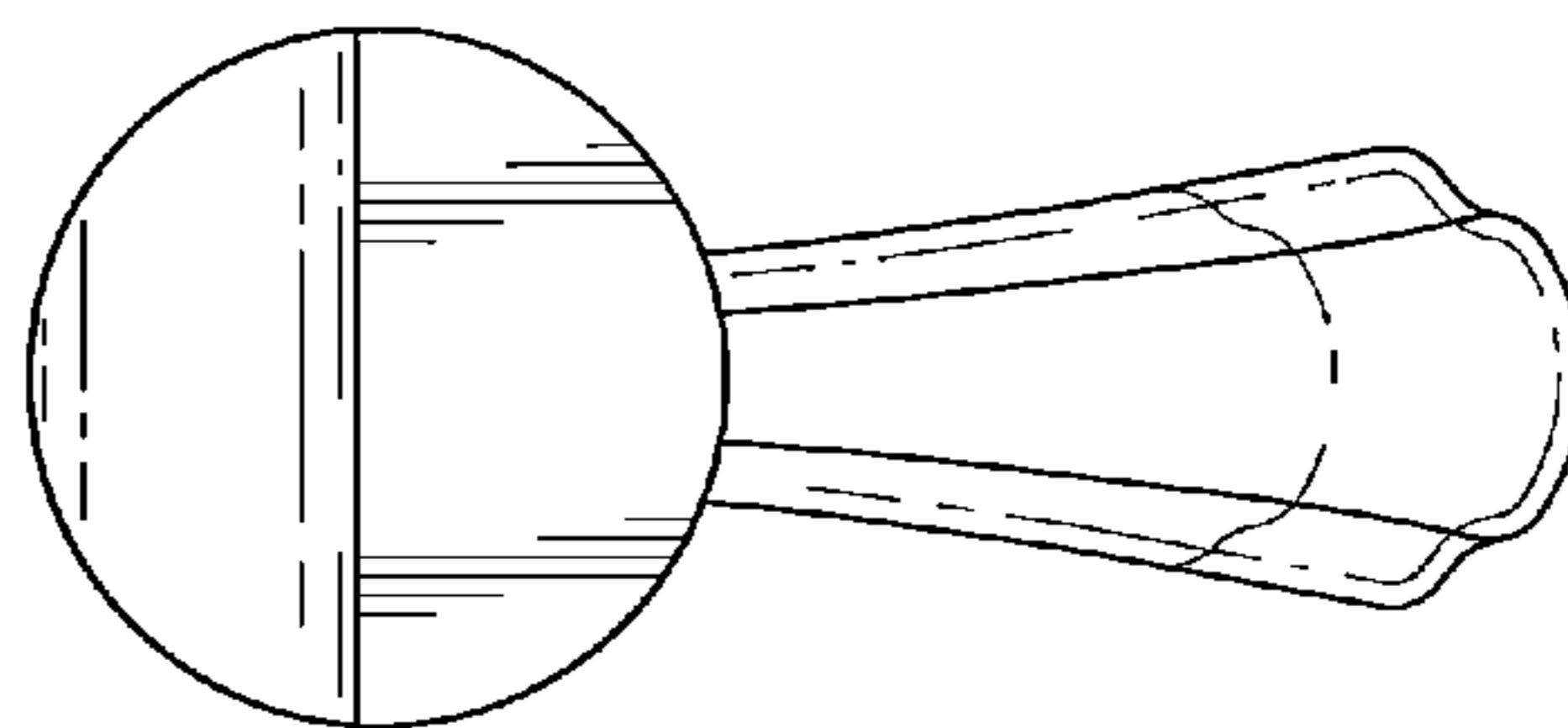

Fig-7