



US00D676934S

(12) **United States Design Patent**
Obara et al.

(10) **Patent No.:** **US D676,934 S**

(45) **Date of Patent:** **** Feb. 26, 2013**

(54) **HANDLE FOR FAUCET**

(75) Inventors: **Mitsuya Obara**, Morrow, GA (US);
Masafumi Ishikawa, Fukuoka (JP)

(73) Assignee: **TOTO Ltd.** (JP)

(**) Term: **14 Years**

(21) Appl. No.: **29/415,222**

(22) Filed: **Mar. 8, 2012**

(51) **LOC (9) Cl.** **23-01**

(52) **U.S. Cl.** **D23/252**

(58) **Field of Classification Search** D23/238-243,
D23/250, 252, 254, 249, 245; 4/675-678;
137/801

See application file for complete search history.

(56) **References Cited**

U.S. PATENT DOCUMENTS

D428,642 S *	7/2000	Milrud et al.	D23/254
D606,171 S *	12/2009	Lammel et al.	D23/254
D649,226 S *	11/2011	Obara et al.	D23/252

* cited by examiner

Primary Examiner — Robert Delehanty

(74) *Attorney, Agent, or Firm* — Banner & Witcoff, Ltd.

(57) **CLAIM**

The ornamental design for a handle for faucet, as shown and described.

DESCRIPTION

FIG. 1 is a perspective view of front, top plan and right side of a handle for faucet according to our new design;

FIG. 2 is a front view thereof;

FIG. 3 is a rear view thereof;

FIG. 4 is a left side view thereof;

FIG. 5 is a right side view thereof;

FIG. 6 is a top view thereof; and,

FIG. 7 is a bottom view thereof.

The portions of the article in broken lines are shown for illustrative purposes only and form no part of the claimed design.

1 Claim, 6 Drawing Sheets

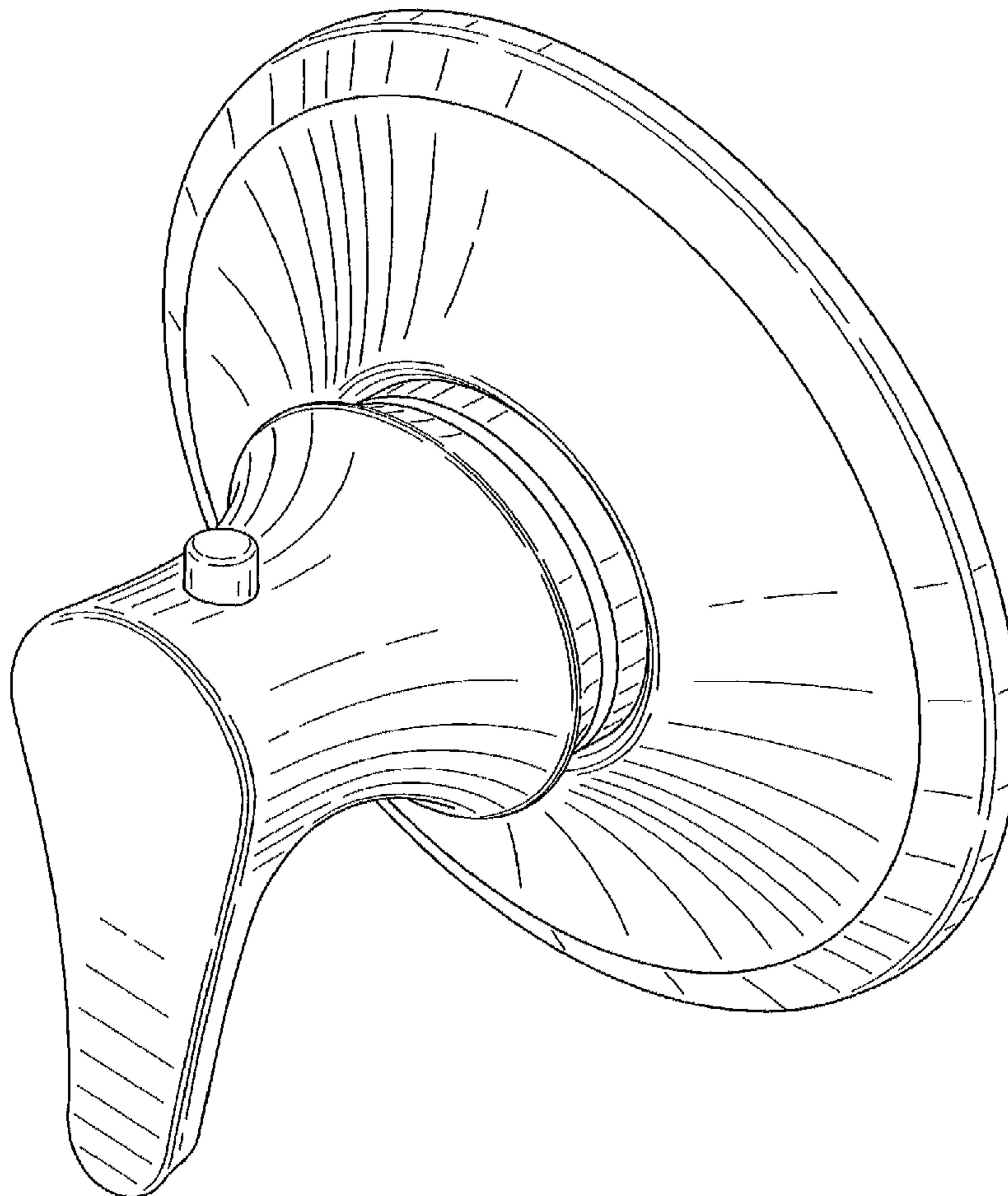

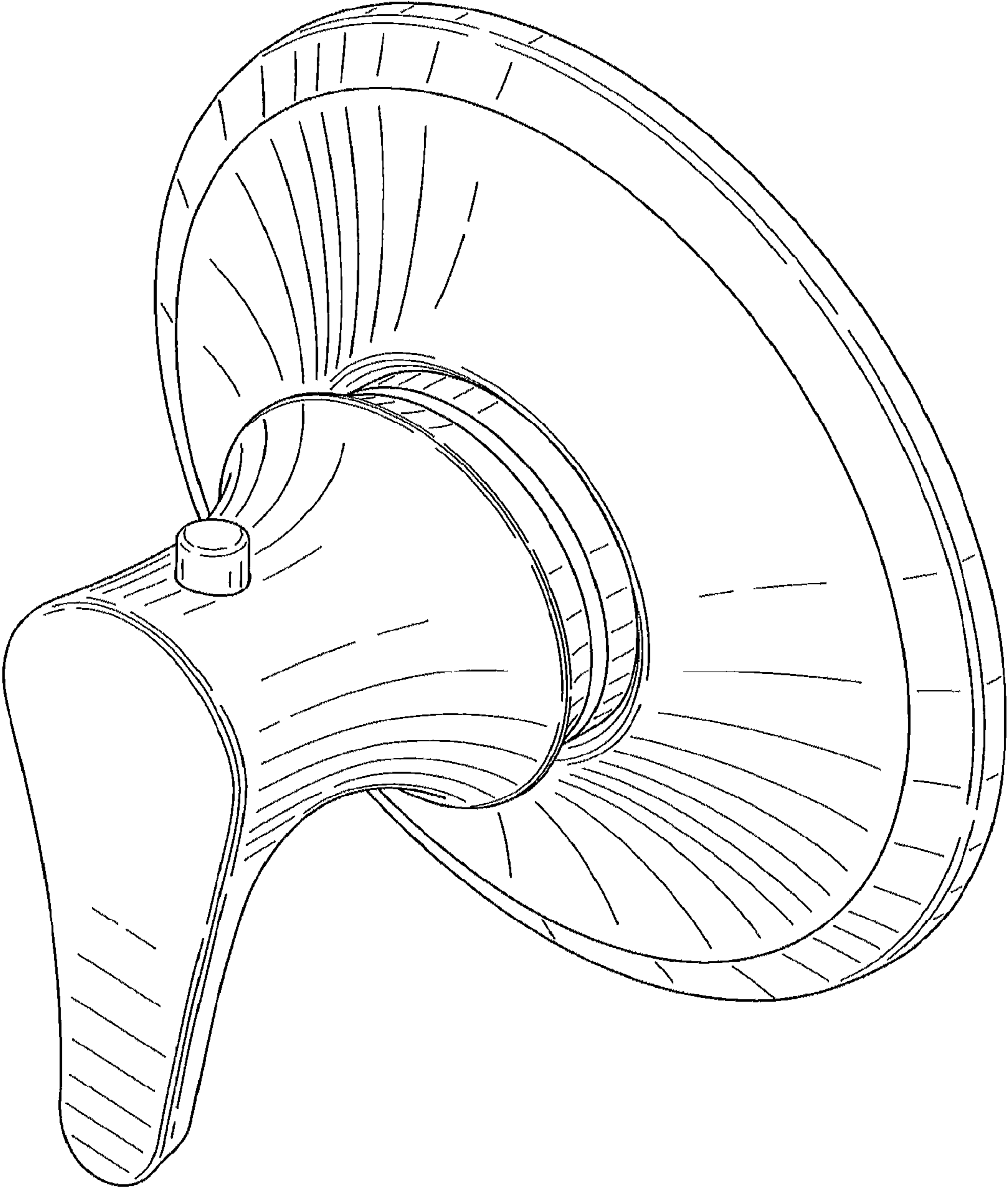

FIG. 1

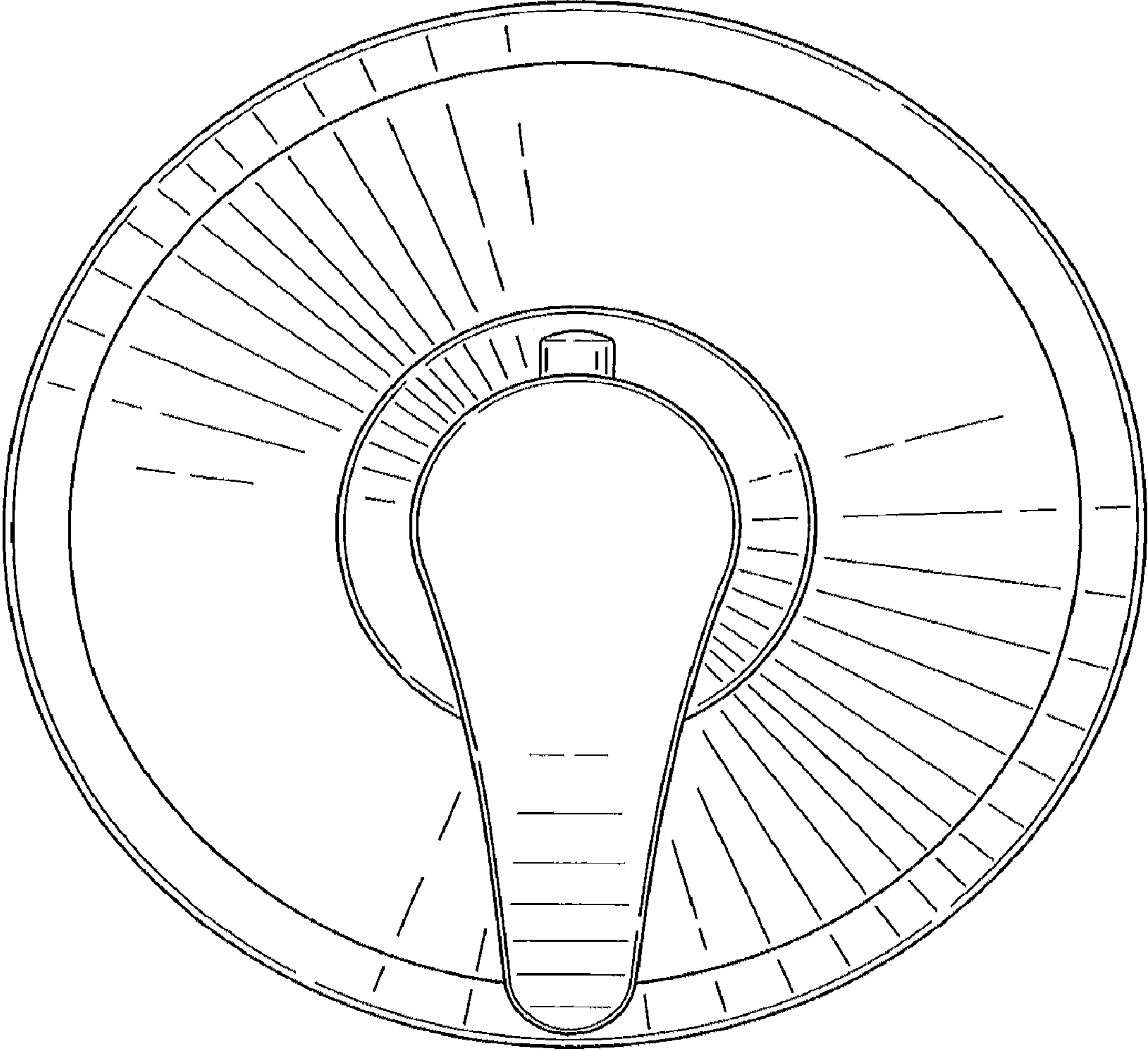

FIG. 2

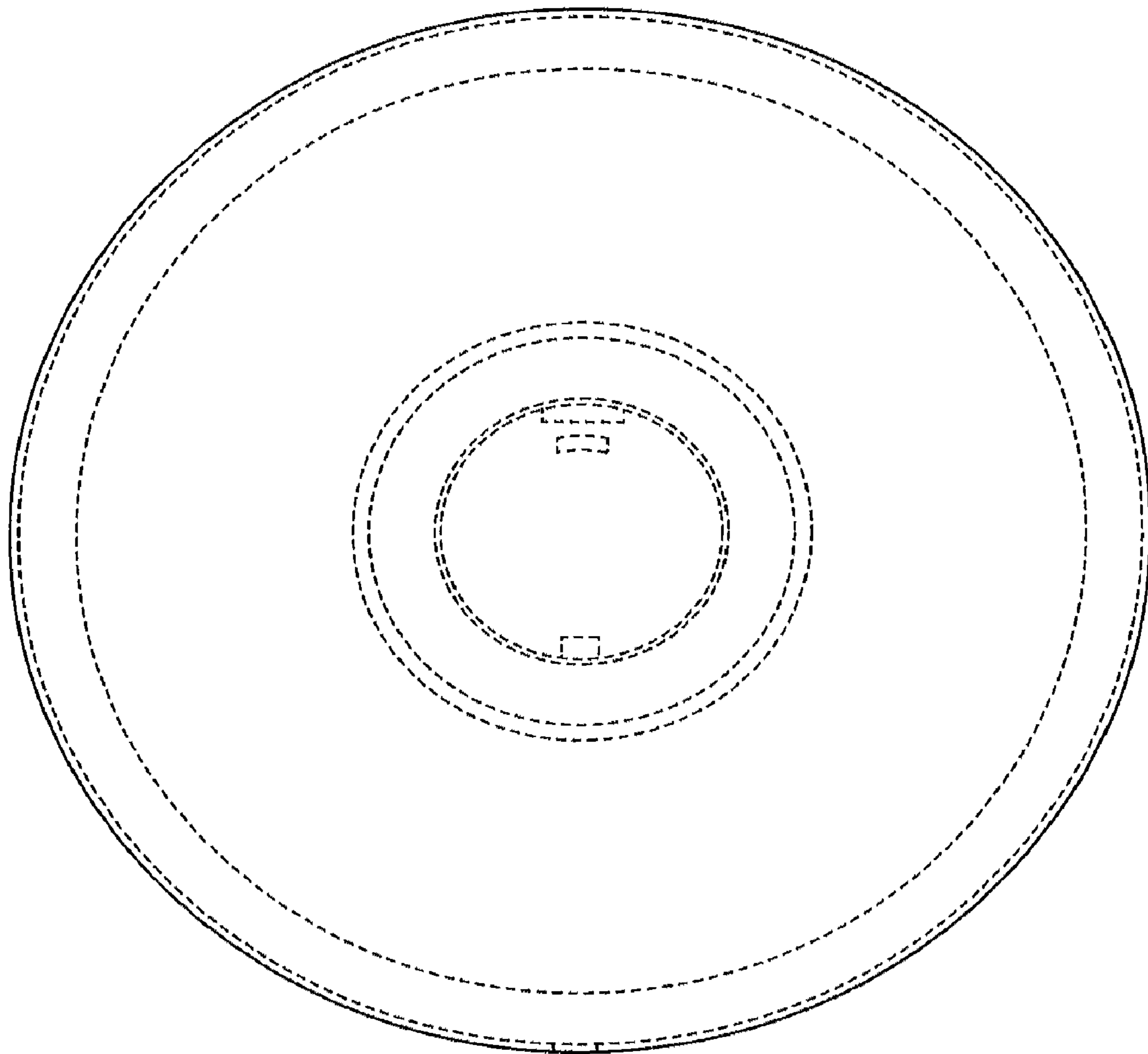

FIG. 3

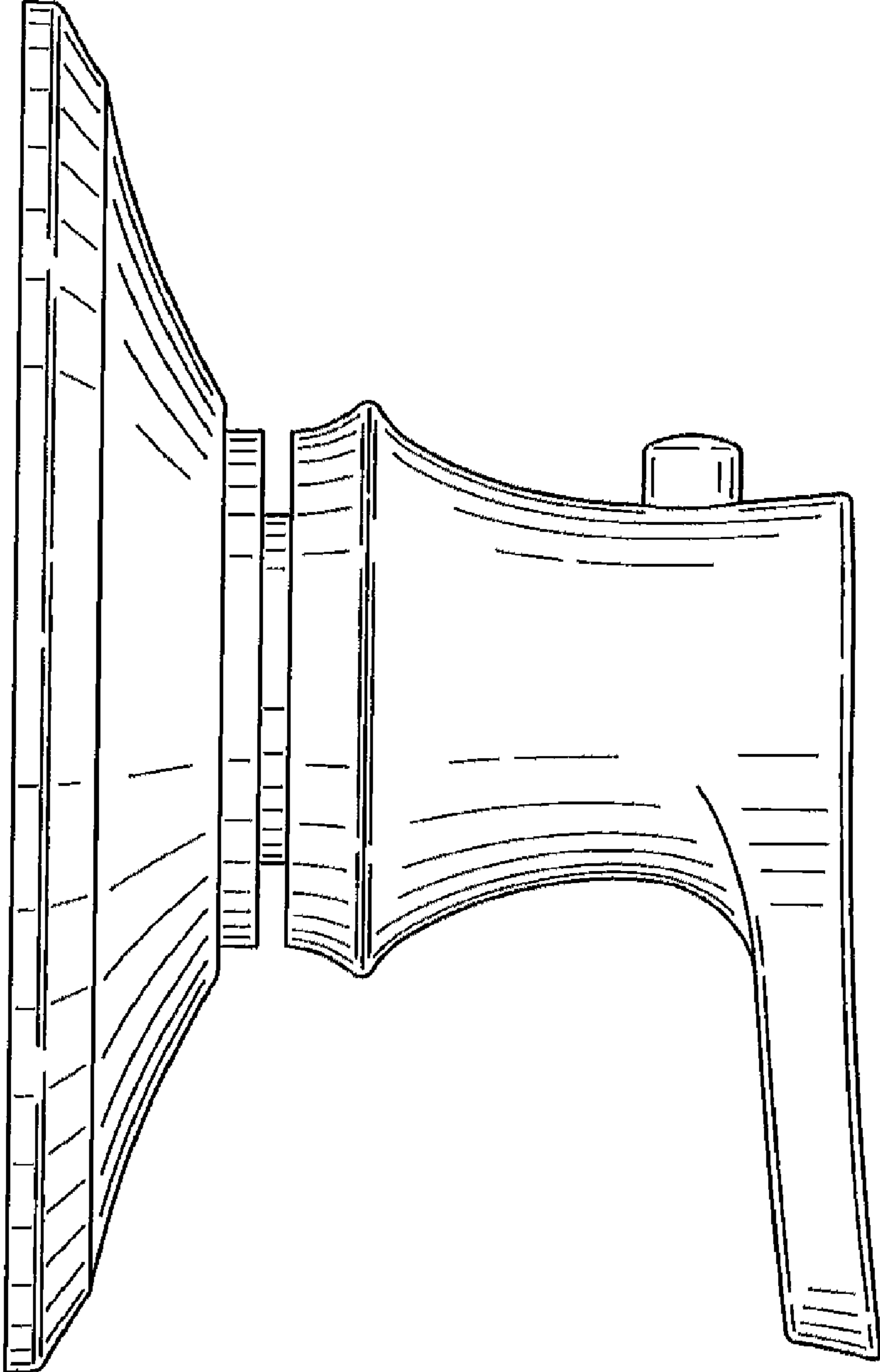

FIG. 4

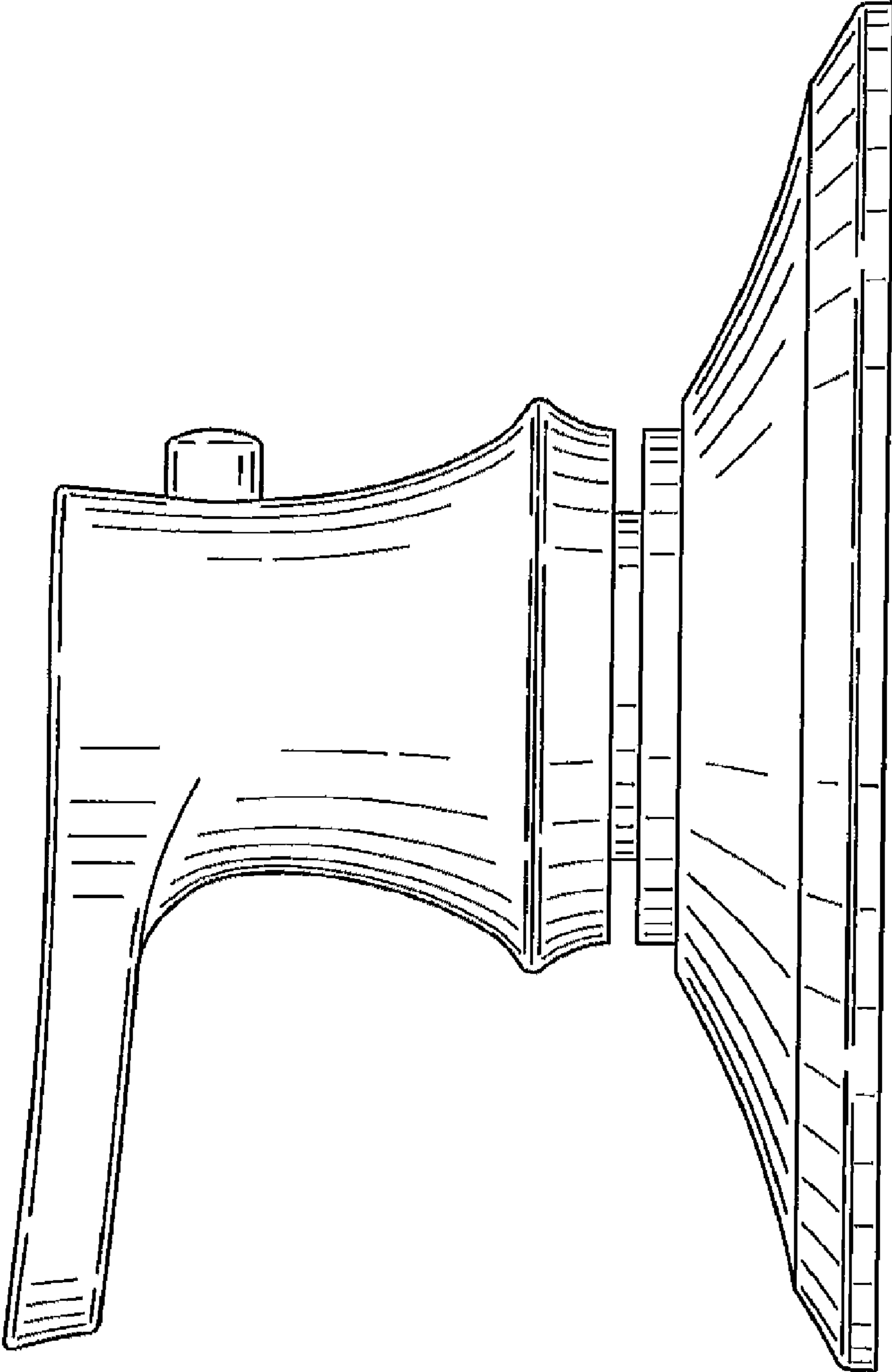

FIG. 5

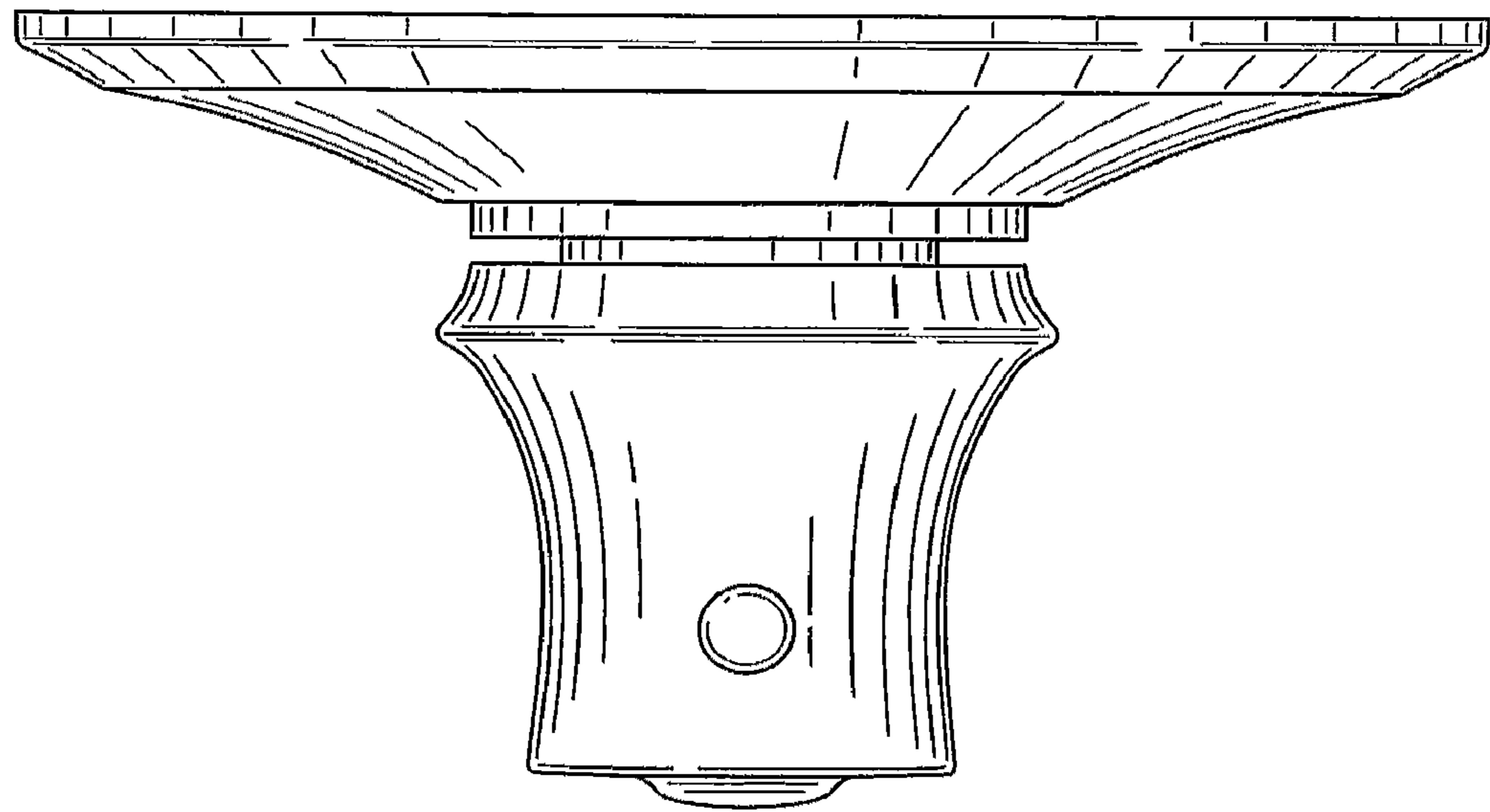

FIG. 6

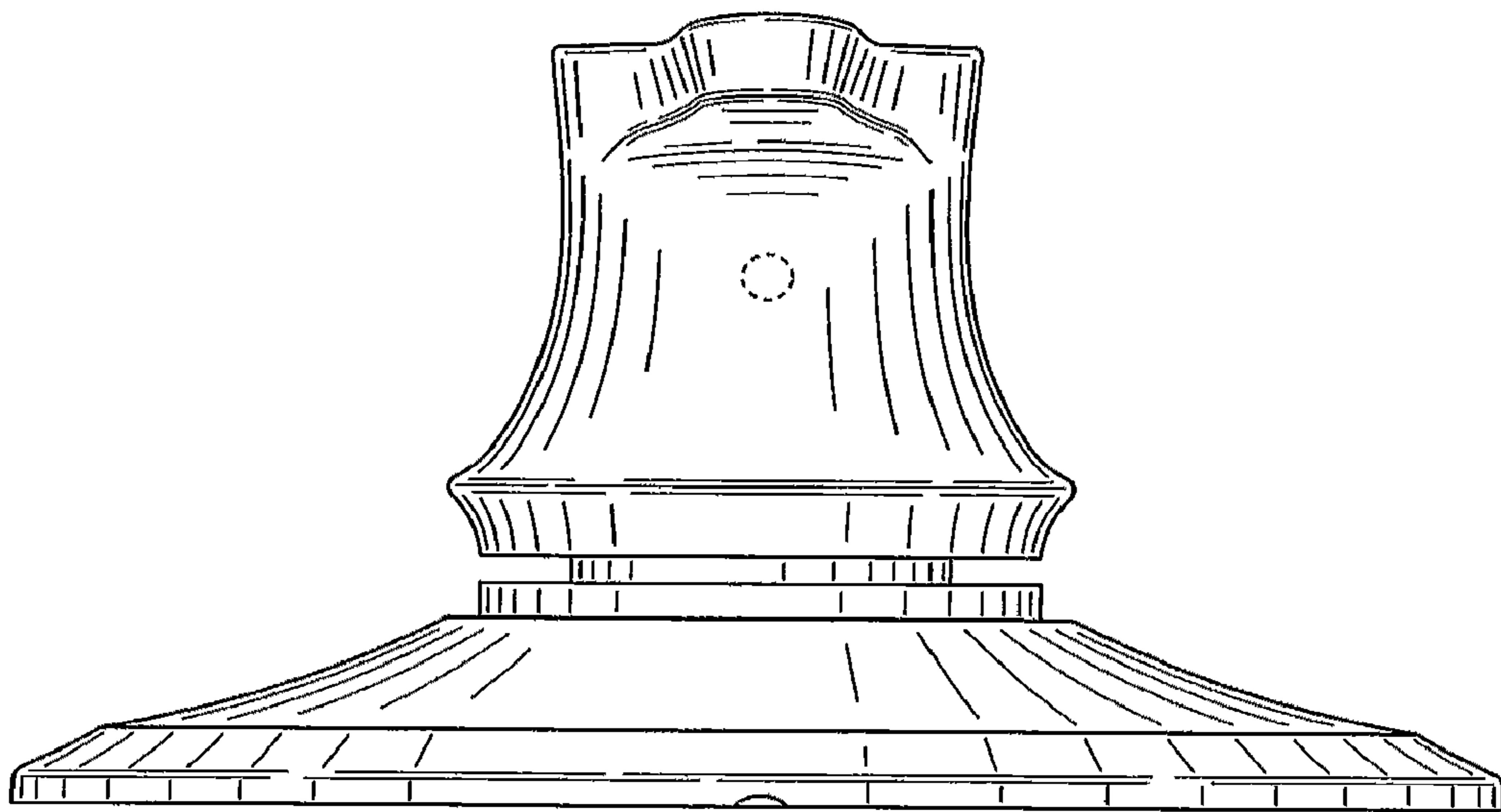

FIG. 7