



US00D676928S

(12) **United States Design Patent**  
**Christopher**

(10) **Patent No.:** **US D676,928 S**

(45) **Date of Patent:** **\*\* Feb. 26, 2013**

(54) **HANDLE FOR A GARDEN HOSE NOZZLE**

D536,765 S \* 2/2007 McCaughan Hay ..... D23/213  
D604,801 S \* 11/2009 Zore ..... D23/213  
D658,268 S \* 4/2012 Bonzer ..... D23/213

(75) Inventor: **Brent Christopher**, Centennial, CO  
(US)

\* cited by examiner

(73) Assignee: **Meridian International Co., Ltd.** (CN)

*Primary Examiner* — Robin V Webster

(74) *Attorney, Agent, or Firm* — Jason R. Sytsma;  
Shuttleworth & Ingersoll, PLC

(\*\*) Term: **14 Years**

(57) **CLAIM**

The ornamental design for the handle for a garden hose nozzle, shown and described.

(21) Appl. No.: **29/419,542**

(22) Filed: **Apr. 30, 2012**

**DESCRIPTION**

(51) **LOC (9) Cl.** ..... **23-01**

(52) **U.S. Cl.** ..... **D23/223**

(58) **Field of Classification Search** ..... D23/213,  
D23/223, 226, 229, 230; 239/452, 459, 526  
See application file for complete search history.

FIG. 1 is a front and right-side perspective view of a handle for a garden hose nozzle according to the invention; FIG. 2 is a front view of the handle of FIG. 1; FIG. 3 is back view of the handle of FIG. 1; FIG. 4 is a right-side view of the handle of FIG. 1; FIG. 5 is a left-side view of the handle of FIG. 1; FIG. 6 is a top-side view of the handle of FIG. 1; and, FIG. 7 is a bottom-side view of the handle of FIG. 1.

The broken lines are included for the purpose of illustrating a the environment in which the claimed invention is being used, which form no part of the claimed design.

(56) **References Cited**

**U.S. PATENT DOCUMENTS**

1,140,259 A \* 5/1915 Elliot et al. .... 239/452  
D194,526 S \* 2/1963 Lohmar ..... D23/229  
D220,841 S \* 6/1971 Kelly ..... D23/213

**1 Claim, 5 Drawing Sheets**

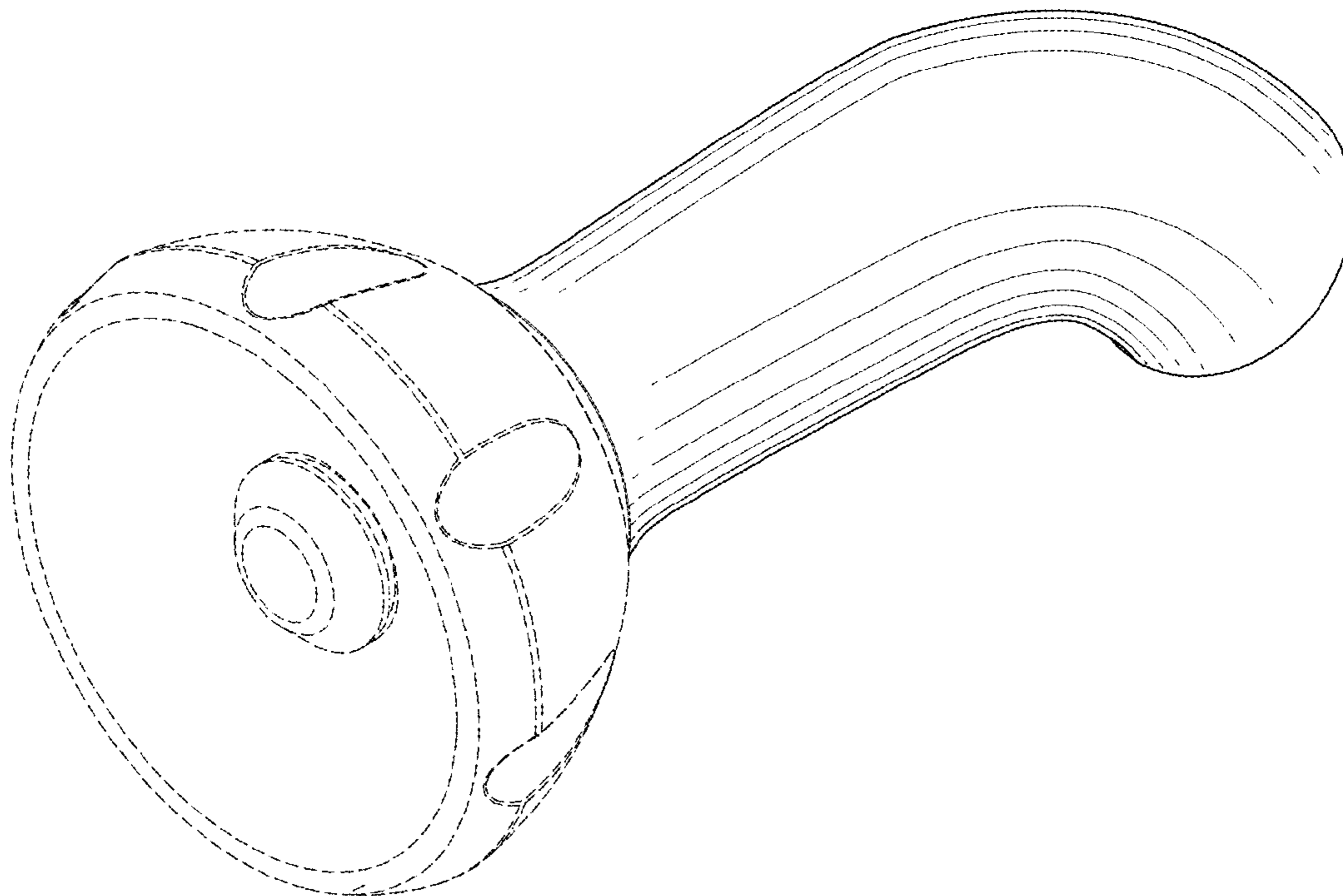

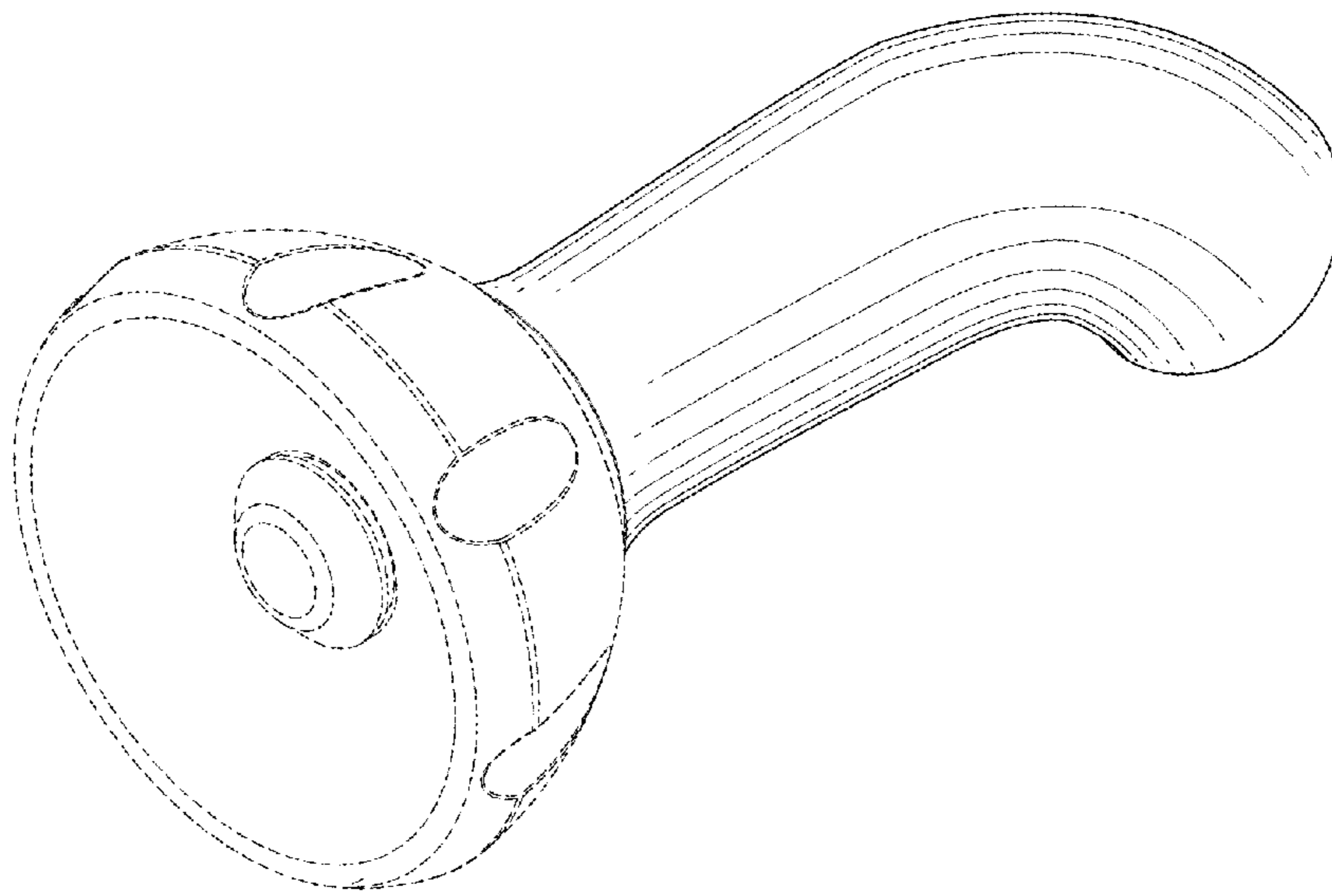

FIG. 1

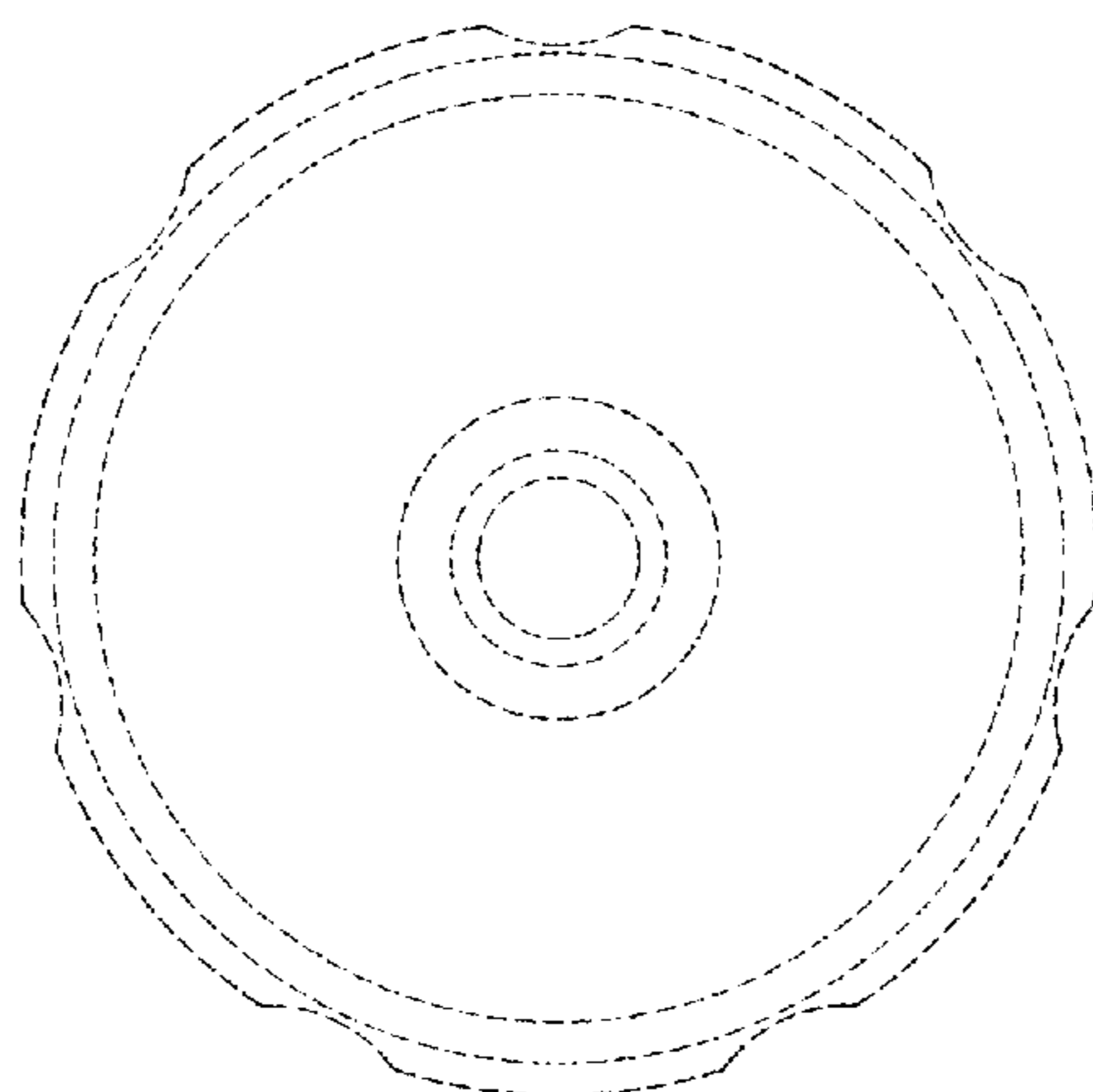

FIG. 2

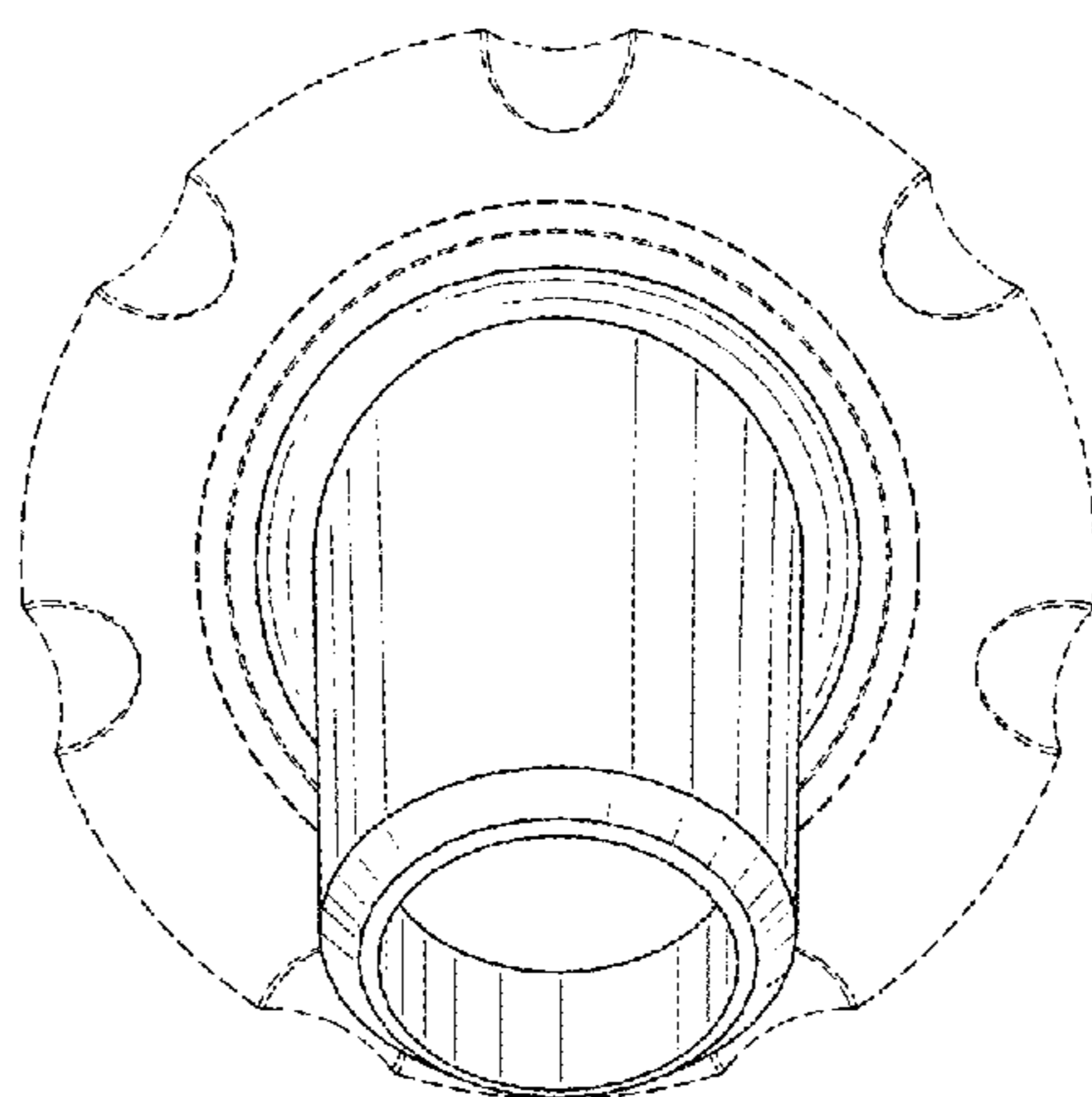

FIG. 3

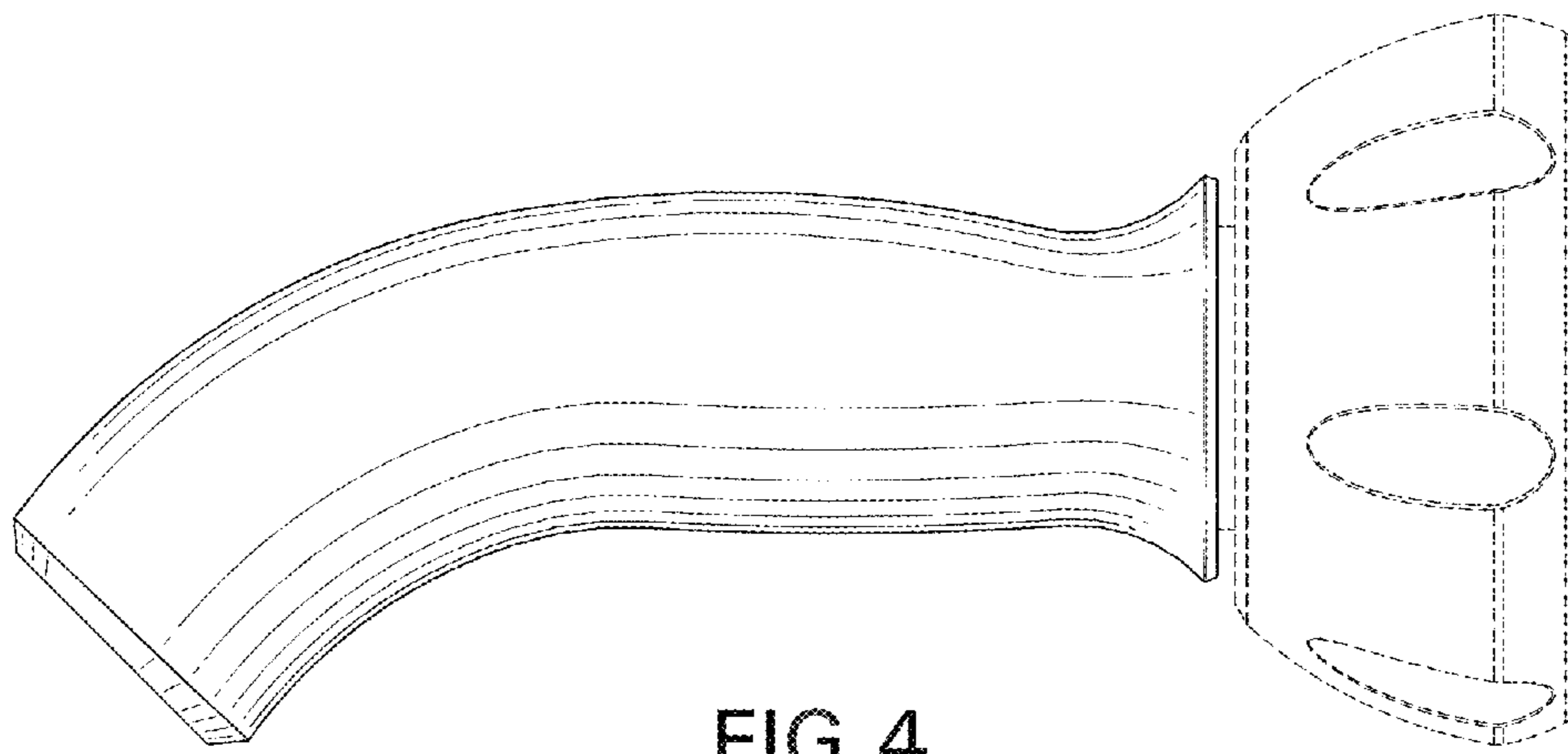

FIG. 4

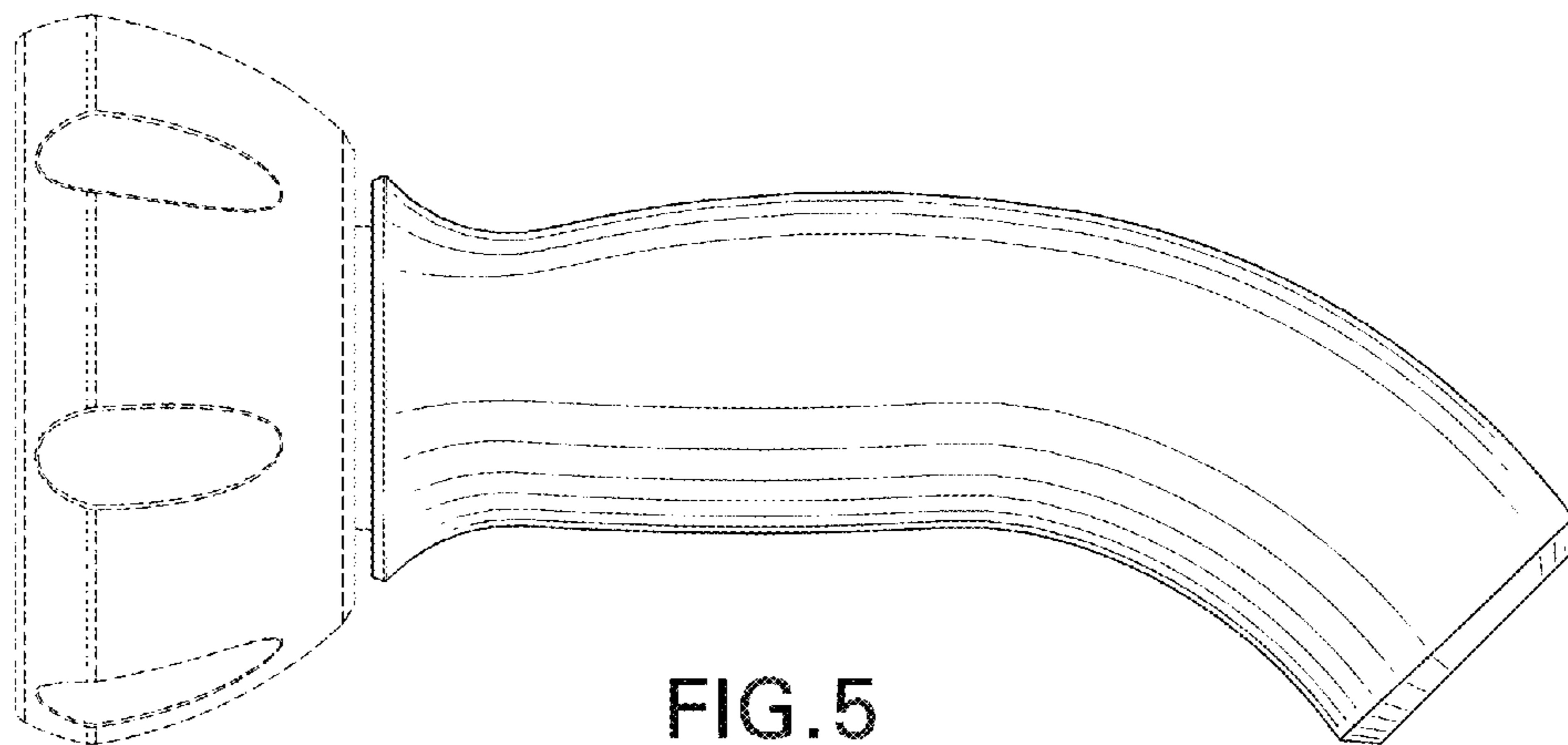

FIG. 5

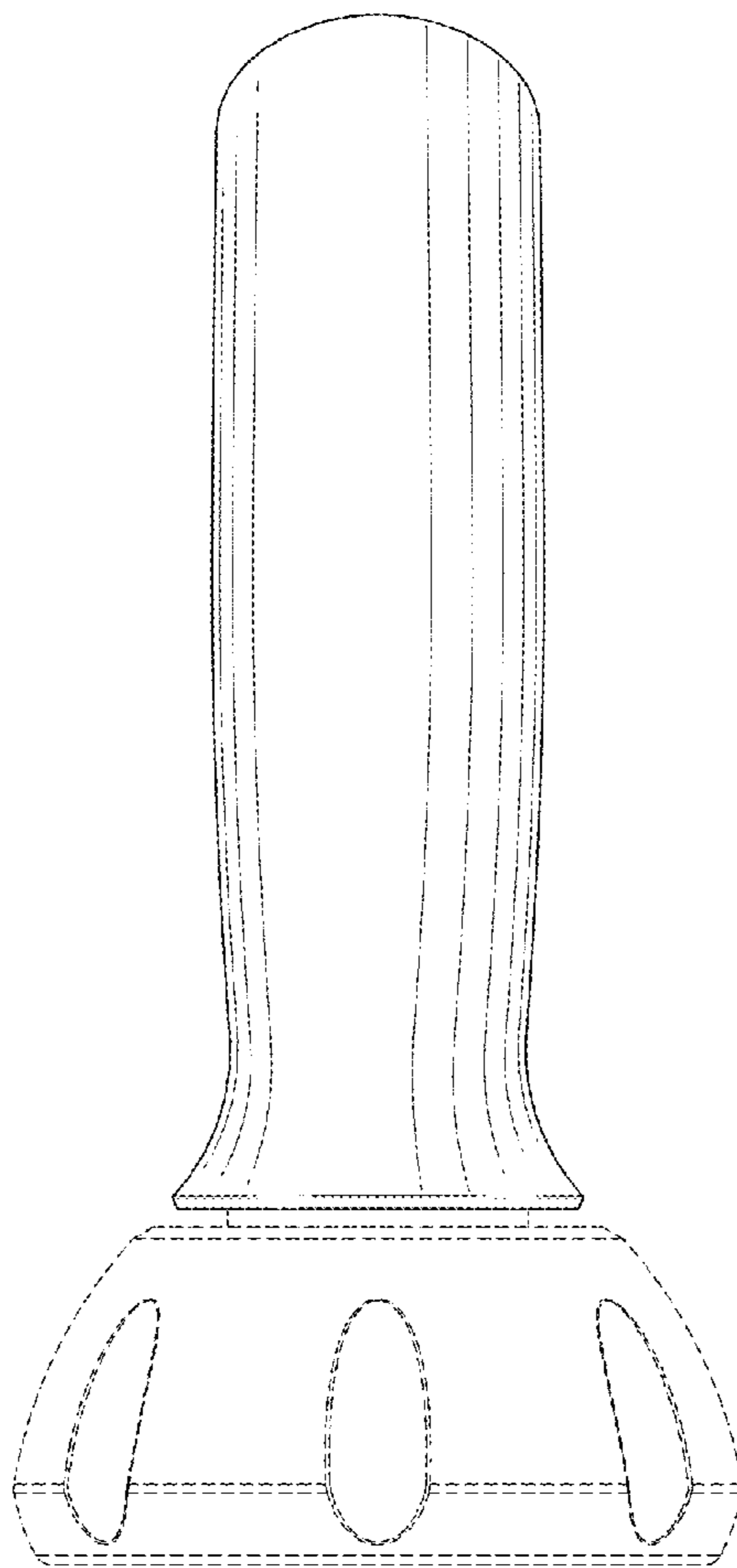

FIG.6

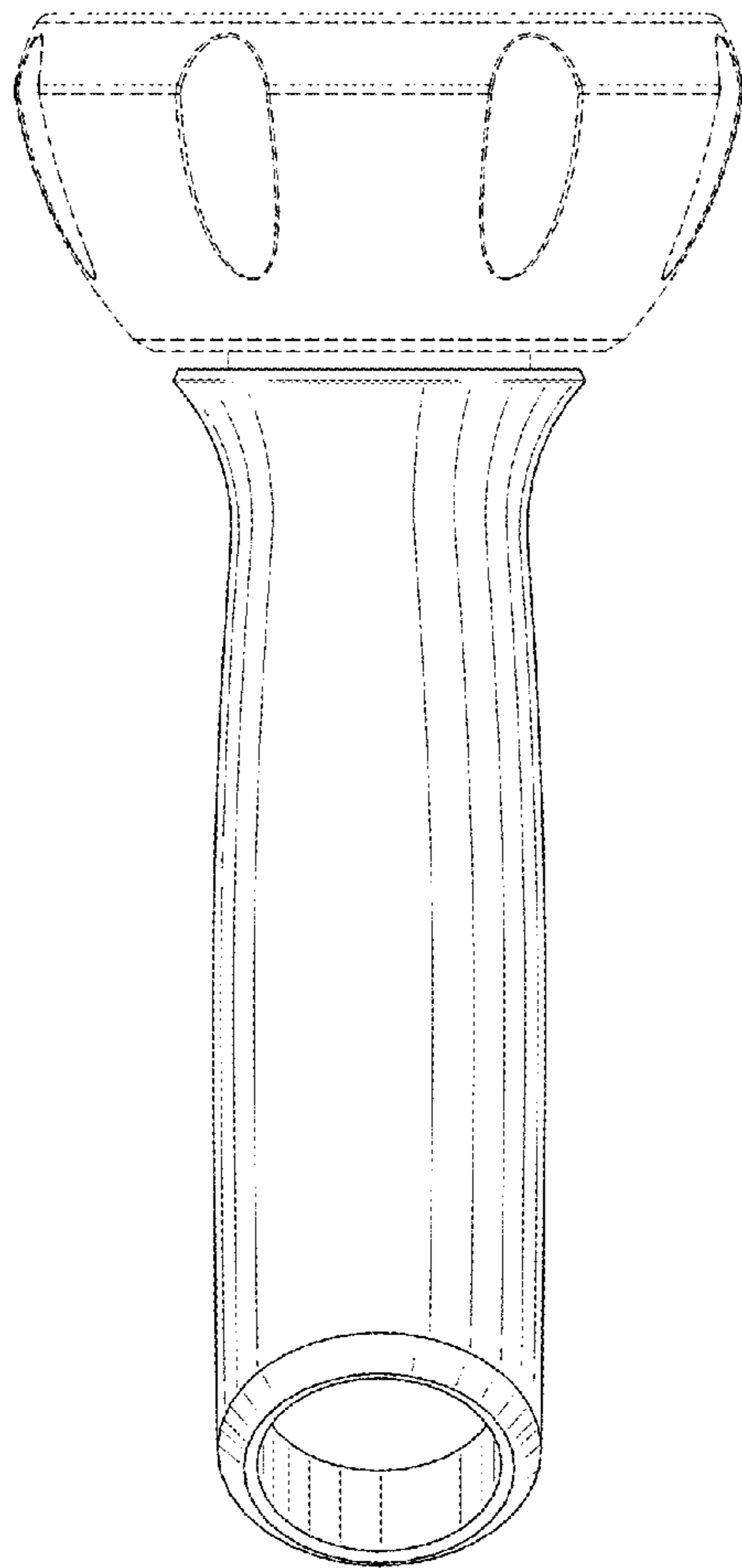

FIG. 7