



US00D676714S

(12) **United States Design Patent**
Chen

(10) **Patent No.:** **US D676,714 S**

(45) **Date of Patent:** **** Feb. 26, 2013**

(54) **CONDIMENT SERVER**

(75) Inventor: **Rui Yuan Chen**, Oxford (GB)

(73) Assignee: **Dart Industries Inc.**, Orlando, FL (US)

(**) Term: **14 Years**

(21) Appl. No.: **29/395,796**

(22) Filed: **Mar. 30, 2012**

(51) **LOC (9) Cl.** **07-06**

(52) **U.S. Cl.** **D7/600**

(58) **Field of Classification Search** D7/500,
D7/501, 505, 549-557, 590, 600, 600.1, 600.2,
D7/600.3, 600.4, 601, 602-607, 609, 610,
D7/619.1, 619.2, 620-623, 630, 632, 637,
D7/638, 639-641, 701, 702, 704-708; 206/217,
206/372, 562, 139, 162, 201, 202, 203; 211/71,
211/74, 126.1, 126.71; 248/153, 175;
222/142.1-142.9; 99/448; 294/145, 146

See application file for complete search history.

(56) **References Cited**

U.S. PATENT DOCUMENTS

1,781,357	A *	11/1930	Wolcott	206/201
D96,450	S *	8/1935	Daum	D7/505
2,029,535	A *	2/1936	Langel	294/160
2,061,285	A *	11/1936	McCormick	99/448
D193,308	S *	7/1962	Jackson	D7/501
D194,325	S	1/1963	Swett		
D198,537	S *	6/1964	Long	D7/704
D206,547	S	12/1966	Swett		
D214,333	S	6/1969	Swett		

D216,145	S	11/1969	Swett		
D232,295	S *	8/1974	Vujmovic	D7/600
D244,415	S *	5/1977	Daenen	D7/584
D256,310	S *	8/1980	Daenen	D7/584
D261,465	S *	10/1981	Minchew	D7/555
D330,486	S	10/1992	DeCoster		
D400,402	S *	11/1998	Petkovich, Jr.	D7/549
D418,719	S	1/2000	Lillelund et al.		
D502,406	S *	3/2005	Eddings	D9/752
D504,050	S *	4/2005	Vidal	D7/598
D586,185	S *	2/2009	Tiemann	D7/600.2
D646,925	S *	10/2011	Okajima et al.	D7/402

* cited by examiner

Primary Examiner — Ian Simmons

Assistant Examiner — Shannon Weekley

(74) *Attorney, Agent, or Firm* — John A. Doninger

(57) **CLAIM**

The ornamental design for a condiment server, as shown and described.

DESCRIPTION

FIG. 1 is a top, side and front perspective view of a condiment server showing my new design;

FIG. 2 is a front elevation view, the rear elevation being identical thereto;

FIG. 3 is a right side elevation view, the left side elevation being identical thereto;

FIG. 4 is a top plan view thereof; and,

FIG. 5 is a bottom plan view thereof.

1 Claim, 4 Drawing Sheets

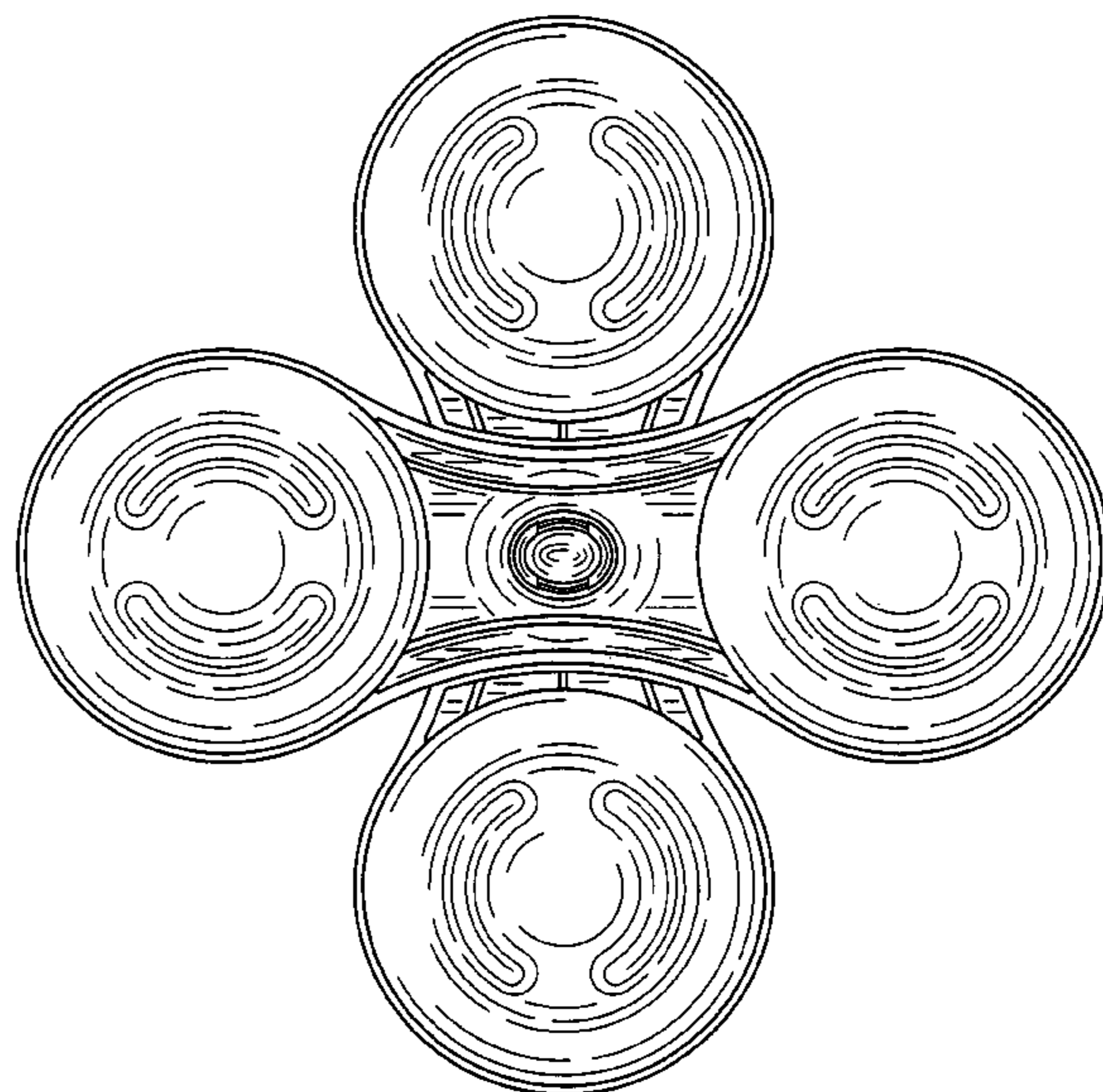
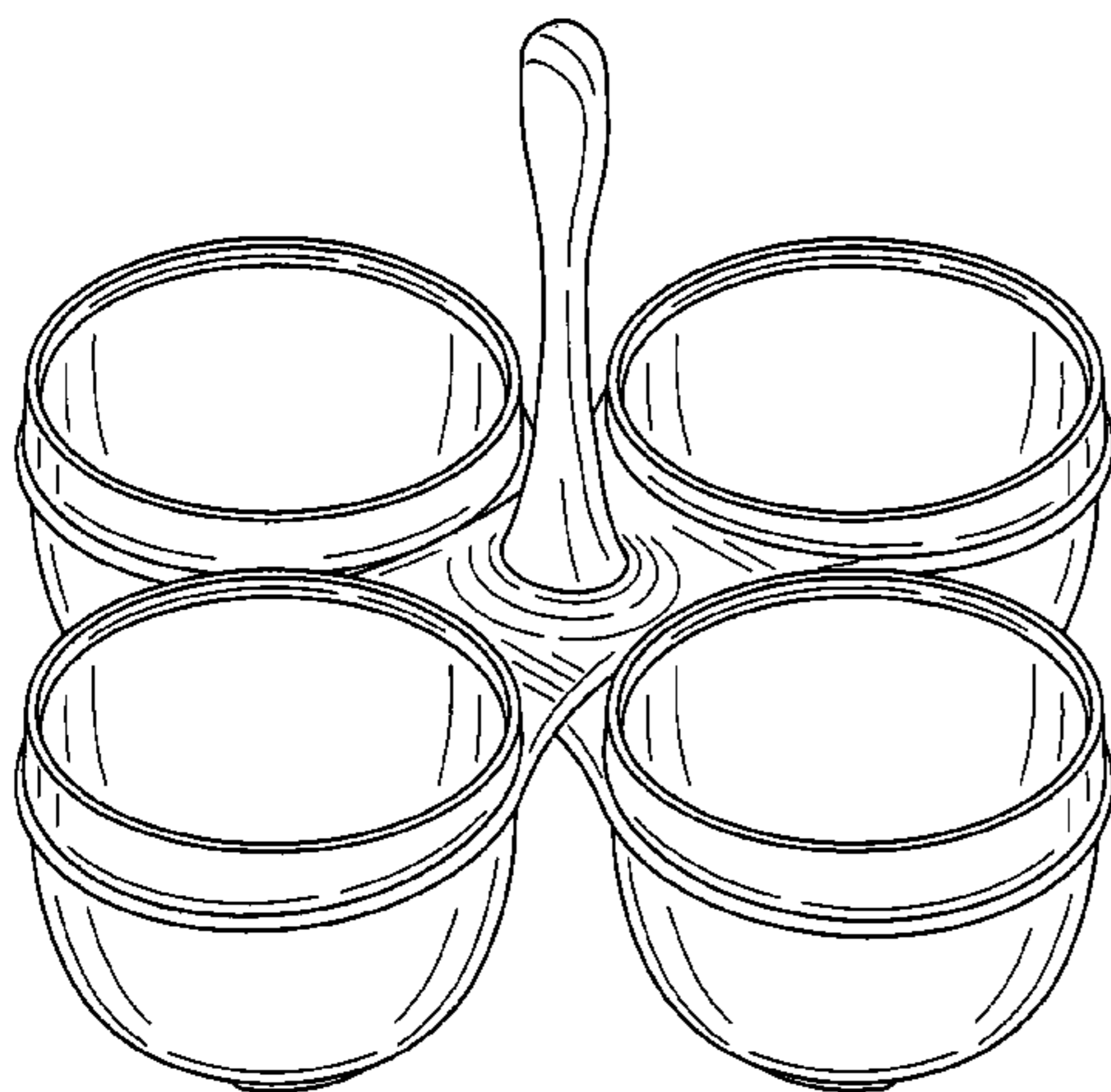

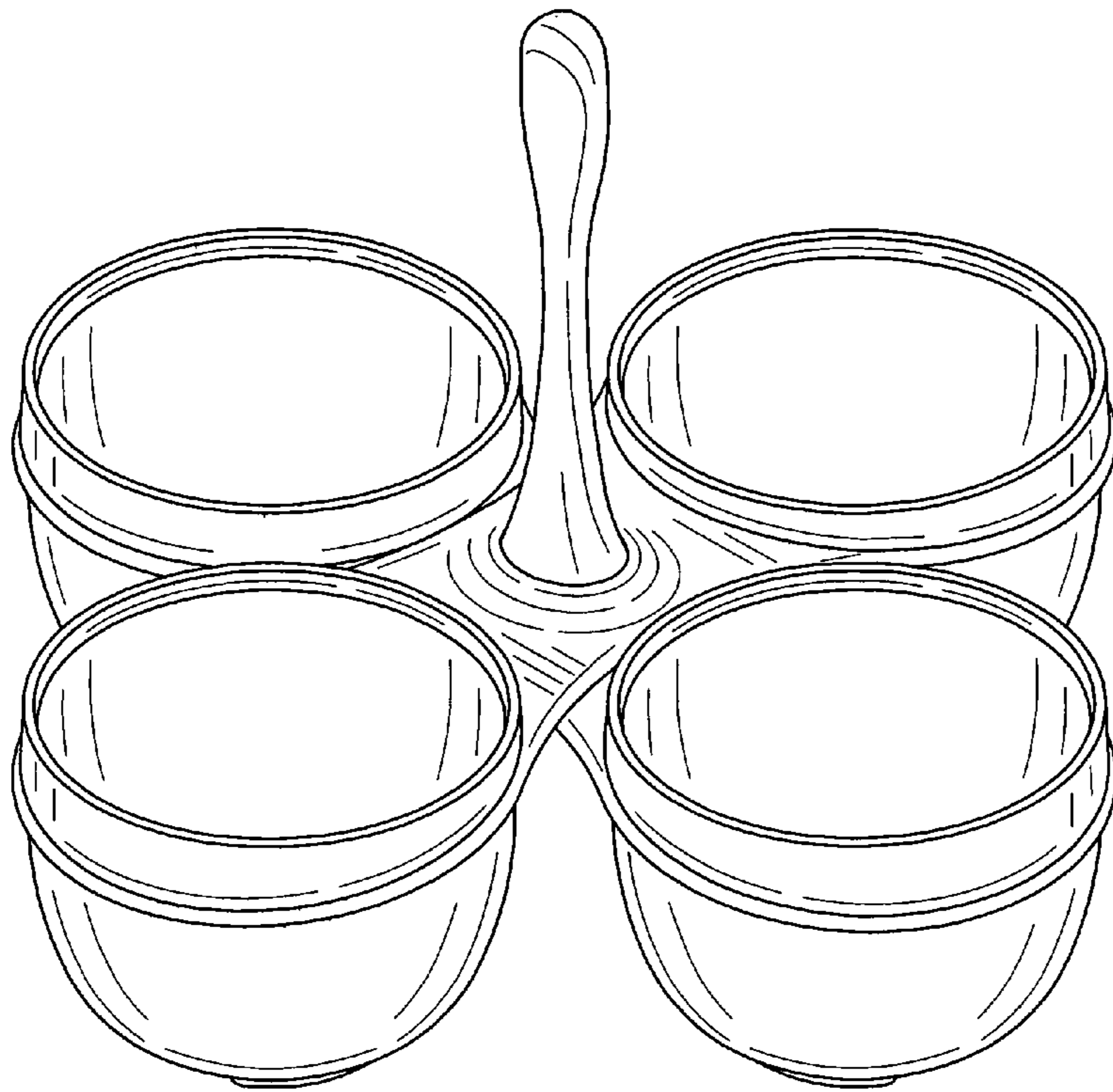

FIG. 1

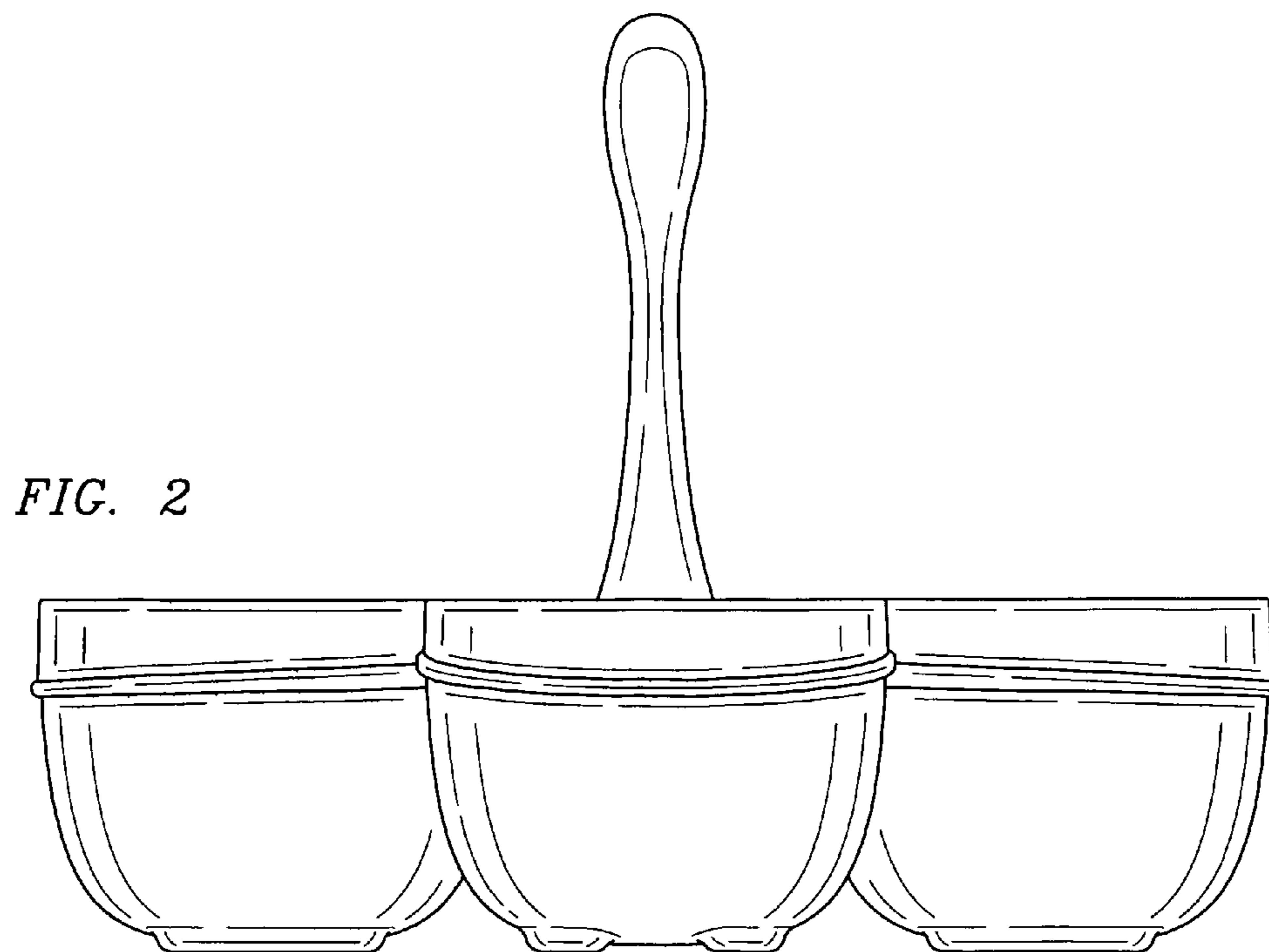

FIG. 2

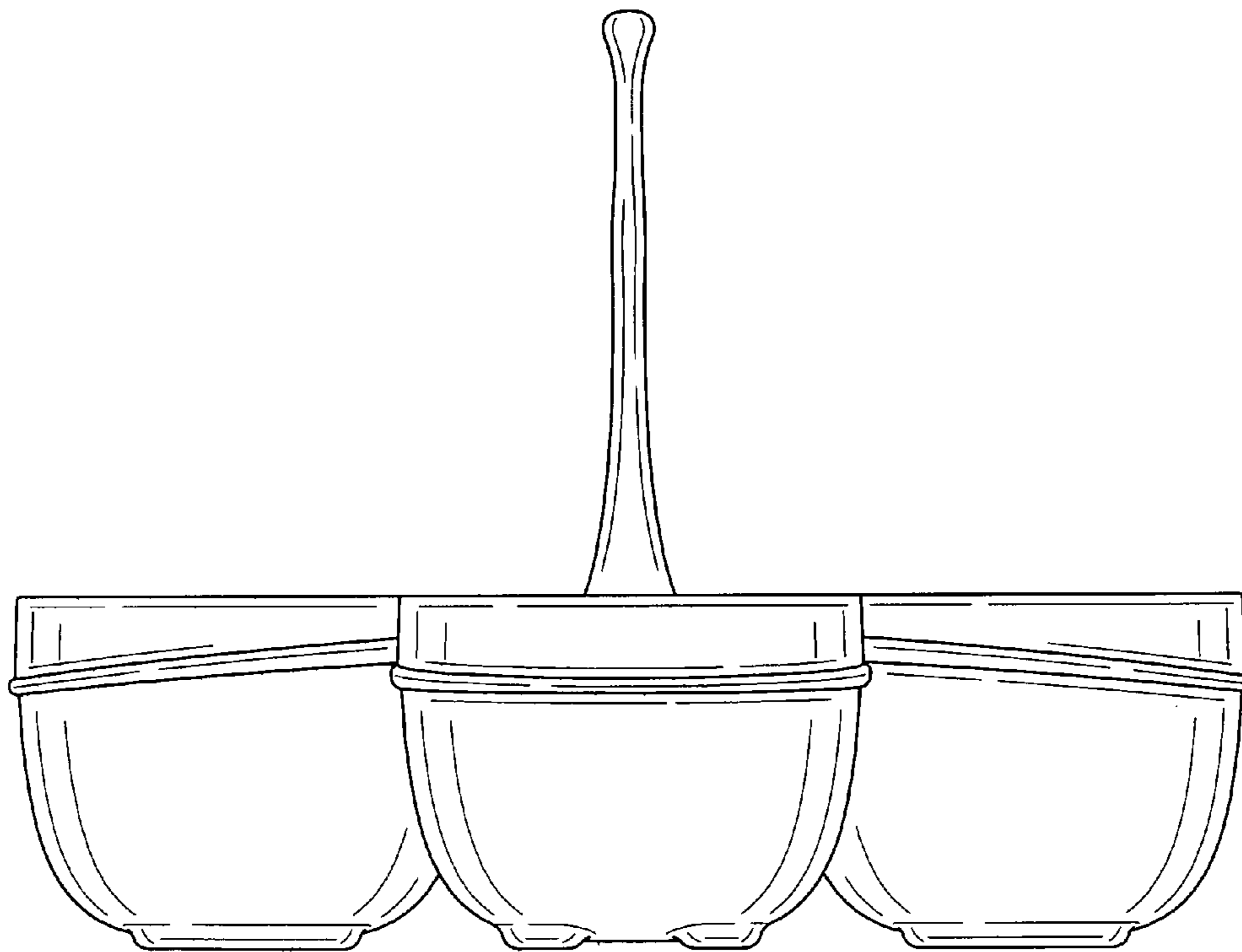

FIG. 3

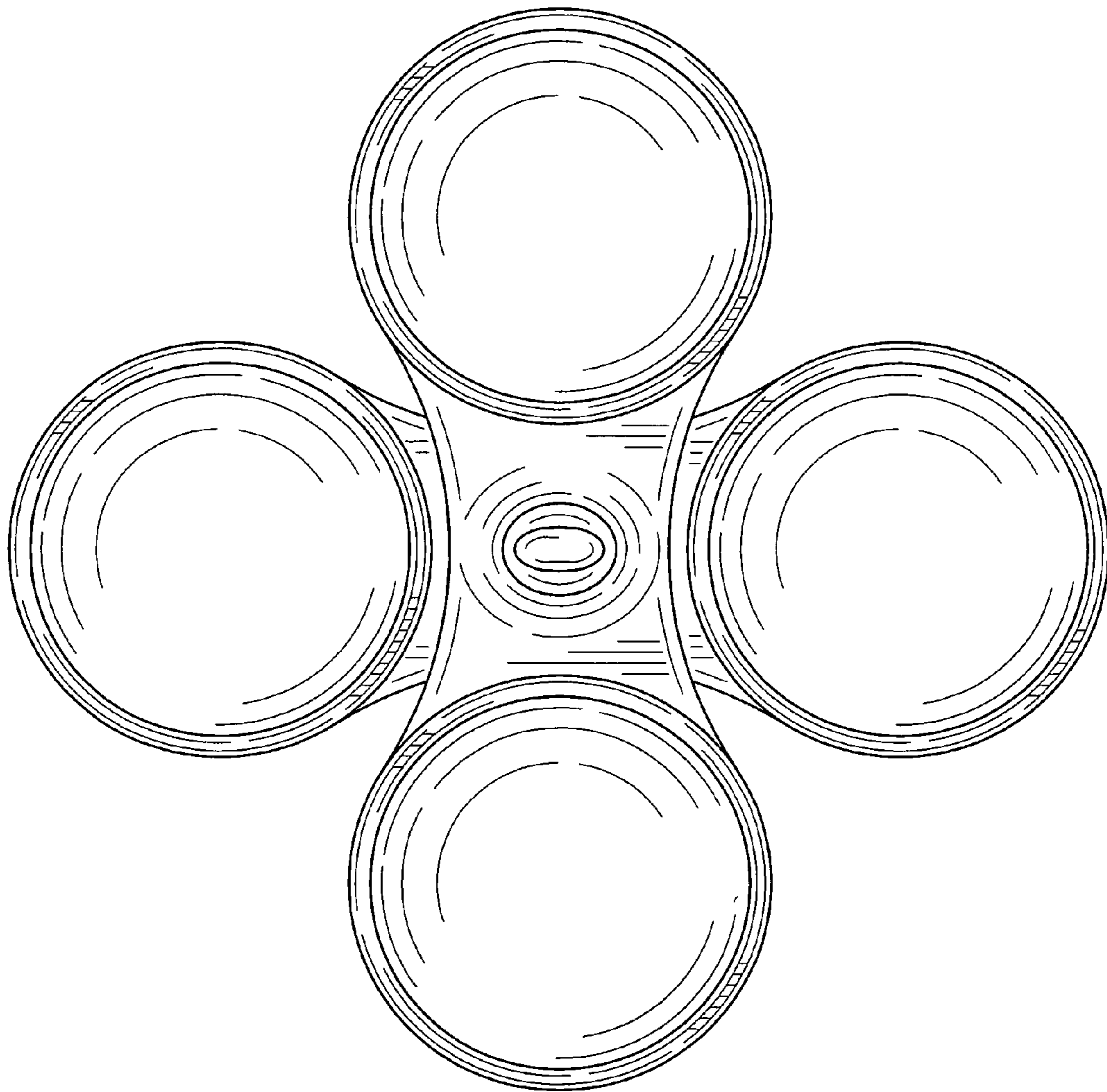

FIG. 4

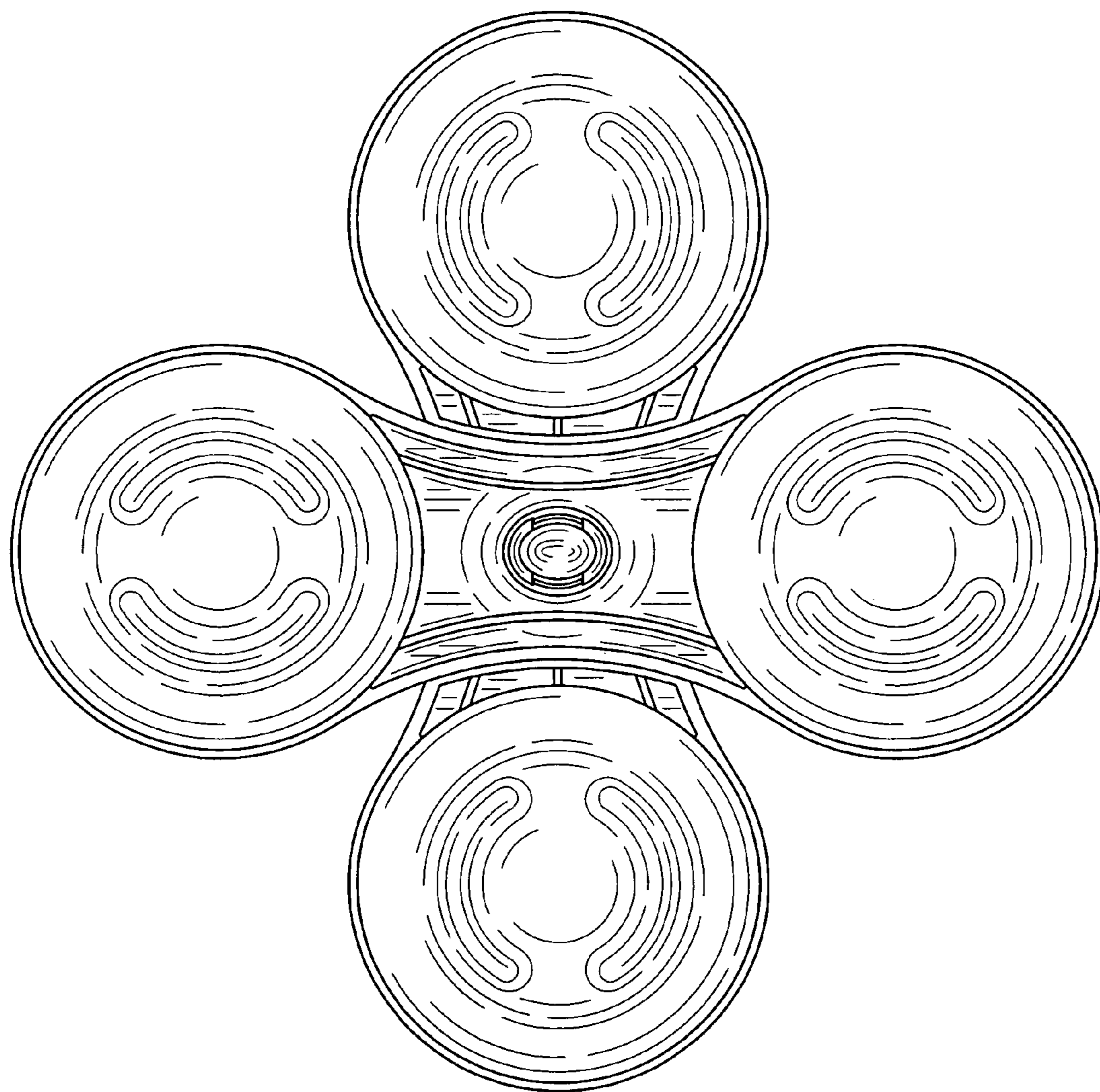

FIG. 5